

LEISTER®

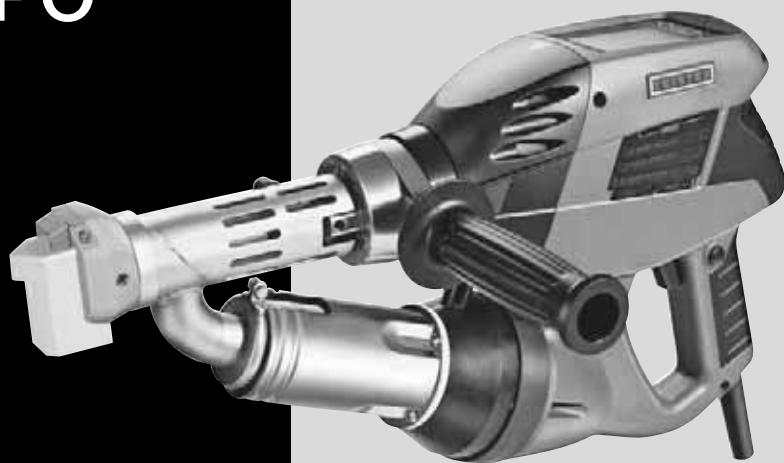

WELDPLAST S2 S2 - PVC S2 - TPO



Leister Technologies AG
Galileo-Strasse 10
CH-6056 Kaegiswil/Switzerland

Tel. +41 41 662 74 74
Fax +41 41 662 74 16

www.leister.com
sales@leister.com

D	Deutsch	Bedienungsanleitung	3
GB	English	Operating Instructions	16
F	Français	Instructions d'utilisation	29
I	Italiano	Istruzioni d'uso	42
E	Espanol	Instrucciones de funcionamiento	55
NL	Nederland	Gebruiksaanwijzing	68
N	Norsk	Bruksanvisning	81
P	Portugês	Instruções de funcionamento	94
S	Svenska	Bruksanvisning	107



Bedienungsanleitung vor Inbetriebnahme aufmerksam lesen und zur weiteren Verfügung aufbewahren.

Leister WELDPLAST S2 / S2-PVC / S2-TPO Hand-Extruder

Anwendung

Extrusionsschweißen von folgenden Materialien:

WELDPLAST S2 PP / PE-HD / PE-LD
WELDPLAST S2-PVC PP / PE-HD / PE-LD / PVC-U
WELDPLAST S2-TPO PP / PE-HD / PE-LD / TPO
Weitere Materialien auf Anfrage

Der Hand-Extruder entspricht der DVS-Norm 2207–4.

DVS: Deutscher Verband für Schweisstechnik



Warnung



Lebensgefahr beim Öffnen des Gerätes, da spannungsführende Komponenten und Anschlüsse freigelegt werden. Vor dem Öffnen des Gerätes Netzstecker aus der Steckdose ziehen. Elektrisch leitendes Material (z.B. PE-EL) darf nicht geschweisst werden.



Feuer- und Explosionsgefahr bei unsachgemäßem Gebrauch des Hand-Extruders (z.B. Überhitzung von Material) besonders in der Nähe von brennbaren Materialien und explosiven Gasen.



Verbrennungsgefahr! Blanke Metallteile und austretende Masse nicht in heissem Zustand berühren. Gerät abkühlen lassen. Heissluftstrahl und austretende Masse nicht auf Personen oder Tiere richten.



Gerät an eine **Steckdose mit Schutzleiter** anschliessen. Jede Unterbrechung des Schutzleiters innerhalb oder ausserhalb des Gerätes ist gefährlich!

Nur Verlängerungskabel mit Schutzleiter verwenden!



Vorsicht



Nennspannung, die auf dem Gerät angegeben ist, muss mit der Netzspannung übereinstimmen. Bei Netzausfall müssen Hauptschalter und Antrieb ausgeschaltet werden (Arretierung lösen).



FI-Schalter beim Einsatz des Gerätes auf Baustellen ist für den Personenschutz **dringend erforderlich**.



Gerät **muss beobachtet** betrieben werden. Wärme kann zu brennbaren Materialien gelangen, die sich ausser Sichtweite befinden.

Gerät darf nur von **ausgebildeten Fachleuten** oder unter deren Aufsicht benützt werden. Kindern ist die Benützung gänzlich untersagt.



Gerät vor **Feuchtigkeit und Nässe** schützen.

Konformität

Leister Technologies AG, Galileo-Strasse 10, CH-6056 Kaegiswil/Schweiz bestätigt, dass dieses Produkt in der von uns in Verkehr gebrachten Ausführung die Anforderungen der folgenden EG-Richtlinien erfüllt.

Richtlinien: 2006/42
2004/108 (bis 19.04.2016), 2014/30 (ab 20.04.2016)
2006/95 (bis 19.04.2016), 2014/35 (ab 20.04.2016)
2011/65

Harmonisierte Normen: EN 12100, EN 55014-1, EN 55014-2, EN 61000-6-2, EN 61000-3-2,
EN 61000-3-3, EN 62233, EN 60335-1, EN 60335-2-45, EN 50581

Kaegiswil, 04.01.2016

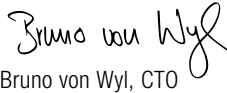
Bruno von Wyl, CTO







Andreas Kathriner, GM

Entsorgung



Elektrowerkzeuge, Zubehör und Verpackungen sollen einer umweltgerechten Wiederverwertung zugeführt werden. **Nur für EU-Länder:** Werfen Sie Elektrowerkzeuge nicht in den Hausmüll!

Technische Daten

Spannung	V~	230	200
Leistung	W	3000	2400
Frequenz	Hz	50/60	
Luftmenge (20 °C)	l/min	300	
Luft-Temperatur	°C	max. 350	
Plastifizier-Temperatur	°C	max. 260	
Ausstoss (Ø 3 mm)	kg/h	PE 0.6–1.3 PP 0.5–1.2 *PVC-U 0.9–1.7 (Mittelwerte bei 50 Hz)	
Ausstoss (Ø 4 mm)	kg/h	PE 1.0–2.3 PP 0.9–2.0 *PVC-U 1.5–2.7 (Mittelwerte bei 50 Hz)	
Schweissdraht	mm	Ø 3 / Ø 4	
Masse L × B × H	mm	450 × 98 × 260 (ohne Schweissschuh)	
Gewicht	kg	5.8 (ohne Netzanschlussleitung)	
Konformitätszeichen			
Sicherheitszeichen			
Schutzklasse I			

* WELDPLAST S2-PVC

Technische Änderungen vorbehalten

Gerätebeschreibung

Mit externer Luftführung

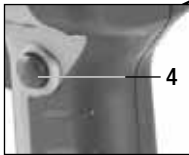
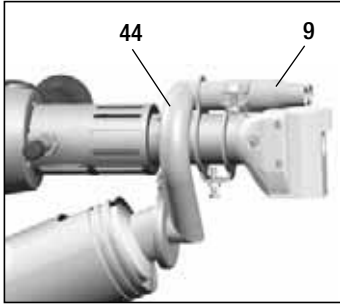

Mit integrierter Luftführung

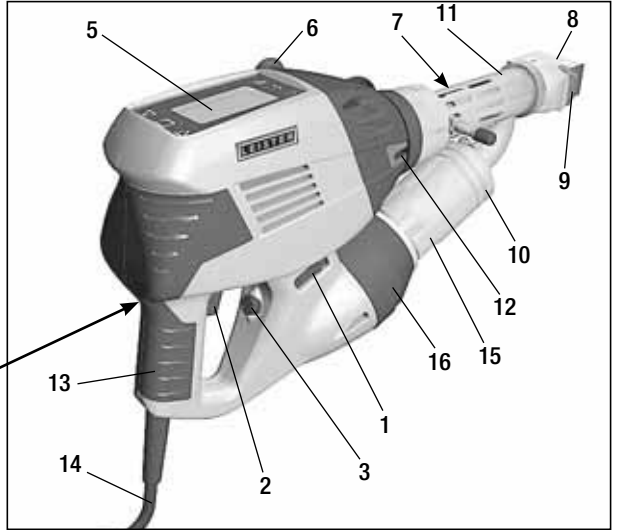

- 1 Hauptschalter
- 2 Ein-/Ausschalter Antrieb
- 3 Potentiometer
- 4 Arretierung Antrieb
- 5 Display
- 6 Handgriff
- 7 Mantelheizung
- 8 Schweissschuh
- 9 Vorwärmdüse

- 10 Rohrklemme
- 11 Schutzrohr
- 12 Schweissdraht-Einführung
- 13 Gerätegriff
- 14 Netzanschlussleitung
- 15 Heizelement - Schutzrohr
- 16 Heissluftgebläse (bürstenlos)
- 44 Externe Heissluftführung

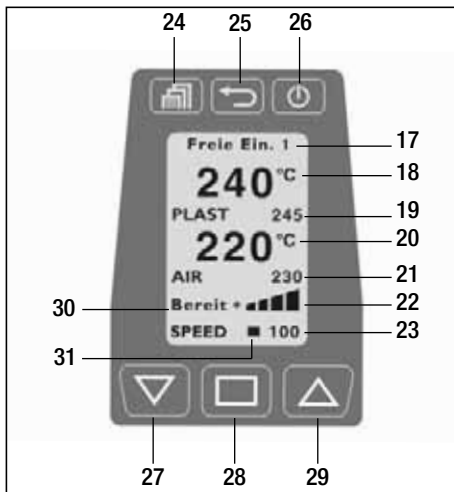

Bedieneinheit

- 17 Schweissprogramm
- 18 Ist-Wert Plastifizier-Temperatur
- 19 Soll-Wert Plastifizier-Temperatur
- 20 Ist-Wert Luft-Temperatur
- 21 Soll-Wert Luft-Temperatur
- 22 Anzeigebalken Antrieb
- 23 Ausstossanzeige
- 24 Menü-Taste
- 25 Back-Taste
- 26 Standby-/ Enter-Taste
- 27 Down-Taste
- 28 Select-Taste
- 29 Up-Taste
- 30 Statusanzeige Antrieb
- 31 Cursor

Arbeitsumgebung / Sicherheit



Der Hand-Extruder darf nicht in explosionsgefährdeter bzw. entzündbarer Umgebung eingesetzt werden. Auf sicheren Stand bei der Arbeit achten. Netzanschlussleitung und Schweißdraht müssen frei beweglich sein und dürfen den Anwender oder Dritte bei der Arbeit nicht behindern.



Hand-Extruder auf feuerfeste Unterlage stellen! Heisse Metallteile und Warmluftstrahl müssen genügend Abstand zu Unterlage und Wänden haben.

Einstellung Handgriff

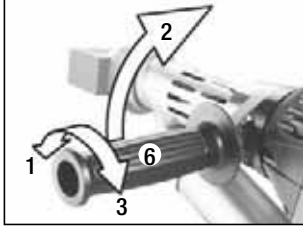

1. Durch Drehen des **Handgriffs (6)** gegen den Uhrzeigersinn Klemmung lösen.
2. **Handgriff (6)** in die gewünschte Arbeitsposition bringen.
3. Durch Drehen des **Handgriffs (6)** im Uhrzeigersinn Klemmung wieder festziehen.

Arbeitsplatz



Zur Inbetriebnahme und Ablage des Hand-Extruders bietet Leister eine **Universal-Geräteablage** an.



Bei Unterbruch der Schweißarbeiten ist der Antrieb mit dem **Ein-/Aus-schalter Antrieb (2)** abzuschalten. Den Hand-Extruder mit entsprechend eingestelltem und fest angezogenem Handgriff gemäss Abbildung auf eine stabile, feuerfeste Unterlage stellen.

Verlängerungskabel

Bei Verwendung von Verlängerungskabeln auf den Mindestquerschnitt achten:

Verlängerungsleitung muss für den Einsatzort (z.B. im Freien) zugelassen und entsprechend gekennzeichnet sein.

Bei Verwendung eines Aggregates zur Energieversorgung gilt für dessen Nennleistung: $2 \times$ Nennleistung Hand-Extruder.

Länge [m]	Mindest-Querschnitt (bei 230V~) [mm ²]
Bis 19	2.5
20 – 50	4.0

Schweissvorbereitung

Die Temperaturüberwachung verhindert das Anfahren des Hand-Extruders in kaltem Zustand.

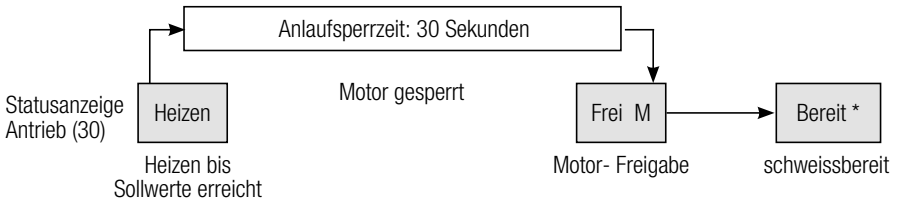

Das Gerät heizt direkt nach dem Einschalten des **Hauptschalters (1)** auf die zuletzt eingestellten Solltemperaturen auf. Sind die Solltemperaturen erreicht, zählt ein Counter in der Statusanzeige von 30 Sekunden zurück auf Null. Nach Ablauf dieses Startvorganges ist das Gerät schweissbereit (Status Bereit*). Der Hand-Extruder erreicht seine Betriebstemperatur nach ca. 4 Minuten.

Bei kurzzeitigem Netzunterbruch entfällt ein erneuter Startvorgang.

Software und Menüführung

Der Hand-Extruder Weldplast S2 ist mit einer komfortablen Bedienersoftware ausgestattet, die dem Anwender die Arbeit erleichtert. Die Tasten sprechen durch leichtes Antippen an.

	Funktionen Arbeitsfenster	Funktionen Menüauswahl
	Menüauswahl	Menüauswahl / Zurück zum Arbeitsfenster
	Kontrast einstellen	Zurück zum Arbeitsfenster (Änderung wird nicht gespeichert!)
	Heizung on/off	Selektieren und zurück zum Arbeitsfenster
	Cursorposition ändern	Selektieren
	Selektierter Wert [+]	Cursor nach oben / Selektierter Wert [+]
	Selektierter Wert [-]	Cursor nach unten / Selektierter Wert [-]

Startfenster

Im Display werden nach dem Einschalten des Hand-Extruders am **Hauptschalter (1)** der Geräte-name und die aktuelle Software-version für 3 Sek. angezeigt.



Arbeitsfenster

Das Arbeitsfenster zeigt die aktuell eingestellten Parameter an.

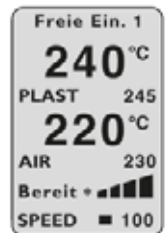

Einstellen der Parameter im Arbeitsfenster

Der **Cursor (31)** zeigt an, welcher Parameter eingestellt werden kann. Nach dem Einschalten befindet sich der Cursor auf der Position «SPEED». Mit der **Select-Taste (28)** können «AIR» oder «PLAST» angewählt und mit der **Up-Taste (29)** oder **Down-Taste (27)** in ihren Werten verändert werden.

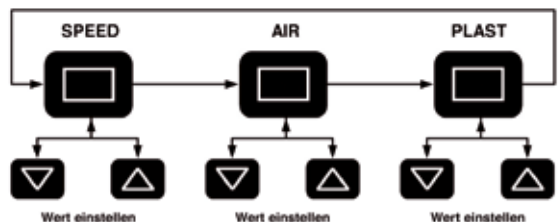

Schweissvorbereitung

Einstellen der Ausstossmenge

Aufgrund der Nahtform können Ausstossmenge und Vorwärmzeit aufeinander abgestimmt werden.

- Voreinstellung am Display
 - Durch Drücken der **Select-Taste (28)** den Cursor auf die Position «SPEED» stellen.
 - Den maximalen Ausstosswert (30 bis 100 %) über die **Up-Taste (29)** oder **Down-Taste (27)** festlegen (wird über den **Anzeigebal-ken Antrieb (22)** dargestellt).
- Feineinstellung während dem Schweissvorgang.
 - Vom maximal eingestellten Ausstosswert (z.B. 85 %) kann durch Drehen des **Potentiometers (3)** die Ausstossmenge auf das Minimum reduziert werden.

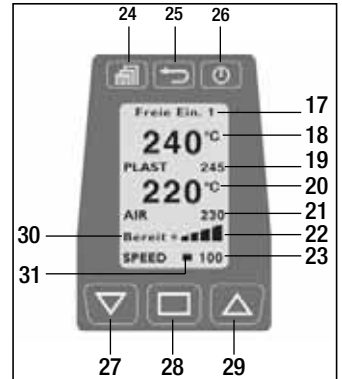

Die Ausstossmenge ist von der verwendeten Schweissdrahtdicke abhängig. Ist der Ausstoss mit Ausstossanzeige «30» und Potentiometerstellung «Minimum» zu gross, muss auf die nächstkleinere Schweissdrahtdicke gewechselt werden.

Einstellen der Plastifizier- und Luft-Temperaturen

- Durch Drücken der **Select-Taste (28)** den Cursor auf die Position «PLAST» bzw. «AIR» stellen.
- Den Temperaturwert über die **Up-Taste (29)** oder **Down-Taste (27)** einstellen.

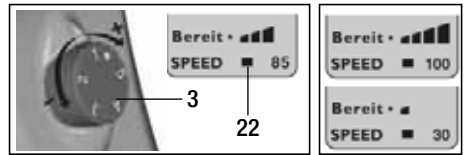

Überwachung der Schweissparameter

Die Soll- und Istwerte der (Air) Luft- und (PLAST) Plastifizier-Temperaturen werden ständig überwacht. Weicht ein Istwert vom entsprechenden Sollwert ab (Wert ist ausserhalb des Toleranzbandes), wird dies auf der **Statusanzeige (30)** durch einen Statuswechsel signalisiert. Wenn nötig wird der Antriebsmotor vorübergehend gesperrt, bis die Schweissparameter wieder im vorgegebenen Toleranzband liegen. Die möglichen Statusanzeigen und die Toleranzbänder sind aus der folgenden Grafik, bzw. Tabelle ersichtlich.

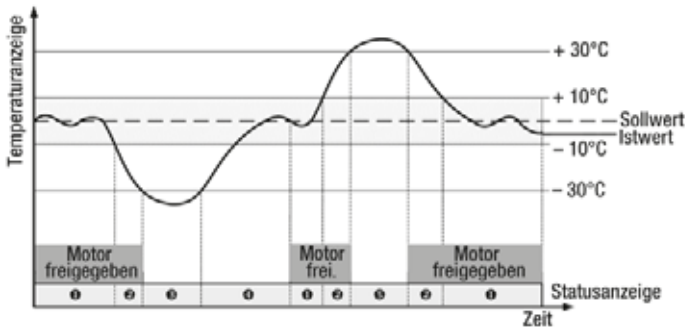

Nr	Statusanzeige	Status-Eigenschaften
①	Bereit*	Schweissbereit
②	Frei M	Abweichung der Schweiss-Parameter (Kunststoff) > 10°C
③	Heizen	Abweichung der Schweiss-Parameter (Kunststoff) > - 30°C, Antriebsmotor gesperrt
④	30s	Anlaufsperrzeit von 30 Sek., Antriebsmotor gesperrt
⑤	zu heiß	Abweichung der Schweiss-Parameter > + 30°C, Antriebsmotor gesperrt

Starten des Schweissvorganges

- Nach Bedarf den entsprechenden **Schweissschuh (8)** montieren.
- **Potentiometer (3)** auf max. einstellen.
- Ist die Betriebstemperatur erreicht (Status Bereit*), kann mit dem Schweißen begonnen werden.
- **Ein-/Ausschalter Antrieb (2)** betätigen.
- Schweißdraht mit dem Durchmesser 3 oder 4 mm in die **Schweißdraht-Einführung (12)** einführen.
- Der Schweißdraht wird automatisch durch die **Schweißdraht-Einführung (12)** eingezogen. Drahtzuführung muss ohne Widerstand erfolgen.



ACHTUNG!

Gerät immer mit Schweißdraht betreiben, jedoch niemals gleichzeitig in beide Schweißdraht-Einführungen Schweißdraht einführen.

- Massförderung mit **Ein-/Ausschalter Antrieb (2)** unterbrechen.
- Die **Vorwärmdüse (9)** auf die Schweisszone richten.
- Mit pendelnden Bewegungen die Schweisszone vorwärmen.
- Das Gerät auf die vorbereitete Schweisszone aufsetzen und den **Ein-/Ausschalter Antrieb (2)** wieder betätigen.
- Testschweißung gemäss Schweißanleitung des Materialherstellers und nationalen Normen oder Richtlinien vornehmen.
- Testschweißung überprüfen.
- Temperatureinstellung und Ausstossmenge nach Bedarf anpassen.
- Bei einem längeren Schweissvorgang kann der **Ein-/ Ausschalter Antrieb (2)** mittels **Arretierung Antrieb (4)** im Dauerbetrieb gehalten werden.

WELDPLAST S2 - PVC

- PVC-U darf nur im Menü PVC-U verarbeitet werden. ACHTUNG: Nur PVC-U verwenden (kein PVC-C!).
- Um Korrosion vorzubeugen wird empfohlen, das Gerät bei längerem Nichtgebrauch (ab 2 Tagen) mit HD-PE zu füllen.

Schweissparameter

Menü		
Programm selektieren		
Auswahl		
Eingabe		

Programm: Die Anzeige der Materialien kann je nach Geräte- und Software-Version abweichen.

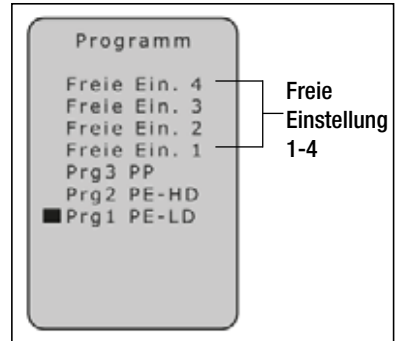

Die **Programme 1 – 3** sind mit entsprechend voreingestellten Parametern versehen, die während des Schweißvorganges angepasst werden können.

Die Anpassungen werden nicht gespeichert!

Die freien Einstellungen 1 – 4 sind vom Werk voreingestellt und können frei programmiert werden. Die Parameter bleiben auch nach dem Ausschalten des Gerätes gespeichert.

Schweißprogramm	Soll PLAST [°C]	Soll AIR [°C]
Freie Ein. 1 – 4	230	260
Prg1 PE-LD	220	260
Prg2 PE-HD	230	260
Prg3 PP	240	260
Prg0 PVC-U	200	300

Das aktuell eingestellte **Schweißprogramm (17)** ist im Arbeitsfenster ersichtlich. Die Anzeige der Materialien kann je nach Geräte- und Software-Version abweichen.

Einstellen der Ausstossmenge

- Durch Drücken der **Select-Taste (28)** den Cursor auf die Position «SPEED» stellen.
- Den Ausstosswert (30 bis 100%) über die **Up-Taste (29)** oder **Down-Taste (27)** einstellen.

Einstellen der Plastifizier- und Luft-Temperatur

- Durch Drücken der **Select-Taste (28)** den Cursor auf die Position «PLAST» bzw. «AIR» stellen.
- Den Temperaturwert über die **Up-Taste (29)** oder **Down-Taste (27)** einstellen.

Ausschalten des Gerätes

- **Arretierung Antrieb (4)** lösen und den **Ein-/Ausschalter Antrieb (2)** loslassen.
Schweißmaterial im Schweißschuh entfernen, damit beim nächsten Anfahren der Schweißschuh nicht beschädigt wird.
- Heizungen mit **Standby-/ Enter-Taste (26)** ausschalten.
- Gerät ca. 5 Min. auskühlen lassen.
- **Hauptschalter (1)** ausschalten.

Weitere Einstellungen



Kontrasteinstellung

Bei ungünstigen Lichtverhältnissen und Umgebungstemperaturschwankungen kann der Kontrast über die **Back-Taste (25)** eingestellt werden.

Heizung ON/OFF

Bei längerem Unterbruch (Standby) kann die Heizung für PLAST und AIR über die **Standby-/Enter-Taste (26)** ausgeschaltet werden.

Tastensperre aktivieren

1. Menü 
2. Tastensperre 
3. Aktivieren 

Wurde die Tastensperre aktiviert, erscheint im Display **Tastensper.**



Die Sperre kann wie folgt wieder zurückgestellt werden:

Tastensperre deaktivieren

1. Back 
2. Rückstellen 
3. Selektieren 

Die Bestätigung durch die Select-Taste muss unmittelbar nach dem Rückstellen erfolgen!

Menüführung

Menü

Menü 

Auswahl  

Selektieren 

Funktionen

Auswahl  

Selektieren und Zurück 

zurück zum Arbeitsfenster Auswahl 

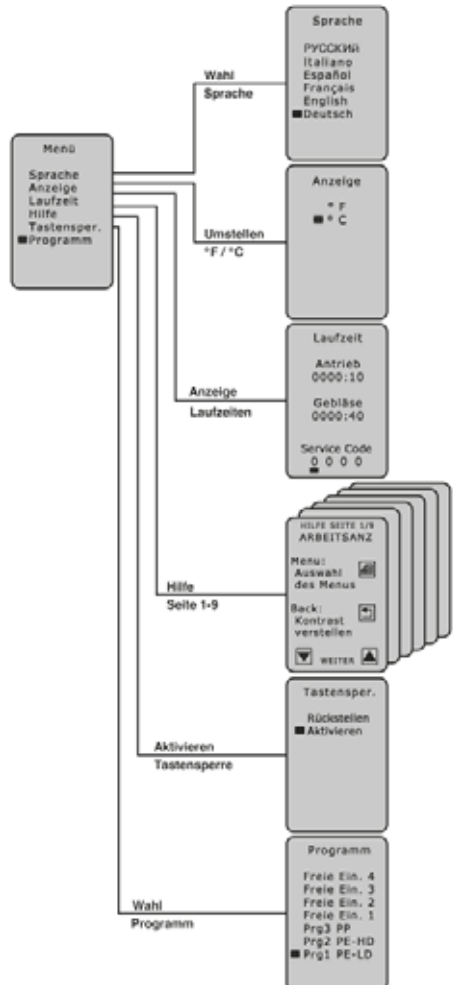

Fehlermeldungen

Tritt ein Fehler auf, wird dieser in der **Statusanzeige (30)** eingeblendet (z.B. **Err04** Motor ist überhitzt).

Anzeige **ErrXX**

Beim Auftreten eines Fehlers werden die Heizungen für AIR und PLAST sowie der Antriebsmotor sofort ausgeschaltet!

Sollte dies nicht geschehen, ist das Gerät sofort vom Netz zu trennen!

Weiteres Vorgehen bei Statusanzeige Antrieb (30) **ErrXX**

- Errorcode notieren.
- **Arretierung Antrieb (4)** lösen und den **Ein-/Ausschalter Antrieb (2)** loslassen.
- **Hauptschalter (1)** ausschalten.
- Das Gerät nochmals überwacht in Betrieb nehmen und darauf achten, dass der Hand-Extruder nicht von aussen überhitzt wird.
- Den in der Schnecke verbliebenen Kunststoff wenn möglich ausstossen.
- Falls der Fehler wieder auftritt, ist das Gerät mit Angabe des Errorcodes zur Kontrolle an die Servicestelle zu senden.

Folgende Fehler werden vom Gerät erkannt:

Anzeige	Art des Fehlers
Err01	Übertemperatur der Luft oder defekte Temperatursonde
Err02	Übertemperatur der Kunststoffmasse oder defekte Temperatursonde
Err04	Übertemperatur in der Motorenwicklung, Motor ist überhitzt
Err08	Übertemperatur des Heizelementes AIR oder Ausfall des Gebläsemotors
Err10	Übertemperatur der Elektronik
Err40	Kurzschluss der Temperatursonde PLAST

Falls mehrere Fehler gleichzeitig auftreten, z.B. **Err02** und **Err04**, wird **Err06** angezeigt.

Weitere Kombinationen werden mit den Buchstaben A, B, C, D, E und F angezeigt,

z.B. **Err08** und **Err02** Anzeige **Err0A**.

Übertemperaturschutz Antrieb

Wird der Antrieb durch äussere Einflüsse oder bei zu niedriger PLAST-Temperatur überhitzt, schaltet der interne Temperaturschutz den Antrieb aus (siehe **Err04**).

Anlaufschutz Antrieb

Der Antriebsmotor ist gegen selbständiges Anfahren nach Fehlern, z.B. Überhitzung **Err04**, gesichert. Es erscheint im **Display (5)** die Anzeige «Antrieb ausschalten», während der Antriebsmotor im blockierten Zustand verharrt. Nach Behebung des Fehlers und Ausschalten des Antriebes (**Arretierung Antrieb (4)** lösen und den **Ein-/Ausschalter Antrieb (2)** loslassen) erlöscht im **Display (5)** die Anzeige «Antrieb ausschalten». Es kann weitergearbeitet werden.

Wechsel von Zubehör



Verbrennungsgefahr!



Nur mit temperaturfesten Handschuhen arbeiten.

Wechsel des Schweisssschuhs

Der Schweisssschuhwechsel muss am betriebswarmen Gerät vorgenommen werden.

Demontage

- Das betriebswarme Gerät abschalten und vom elektrischen Netz trennen.
- Den **Schweisssschuh (8)** mit **Schweisssschuhhalter (34)** durch Lösen der **Klemmschrauben (35)** von der **Extrudierdüse (32)** entfernen.
- Die **Extrudierdüse (32)** bei jedem Schweisssschuhwechsel von Schweissgutrückständen reinigen und sicherstellen, dass sie festgeschraubt ist.
- **Schweisssschuh (8)** durch Lösen der **Befestigungsschrauben (33)** vom **Schweisssschuhhalter (34)** entfernen.

Montage

- Einen der Schweissnaht angepassten **Schweisssschuh (8)** an **Schweisssschuhhalter (34)** mit **Befestigungsschrauben (33)** montieren.
- **Schweisssschuh (8)** und **Schweisssschuhhalter (34)** müssen mit den **Klemmschrauben (35)** gut angezogen werden.

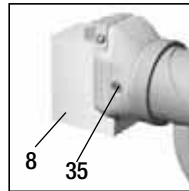
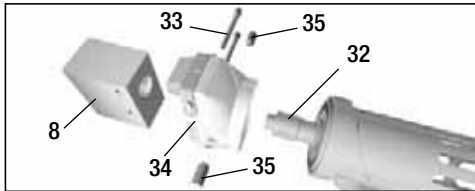

- 8 Schweisssschuh
- 32 Extrudierdüse
- 33 Befestigungsschraube
- 34 Schweisssschuhhalter
- 35 Klemmschraube

Schweissrichtung

Durch Lösen der **Klemmschrauben (35)** kann der **Schweisssschuh (8)** stufenlos in die gewünschte Schweissrichtung gedreht werden. Die **Klemmschrauben (35)** müssen danach wieder gut angezogen werden.

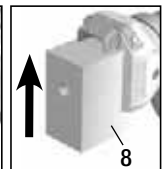
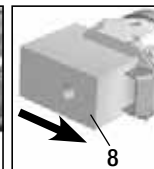
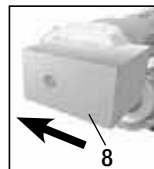

Wechsel der Heissluftführung

Zur Demontage der **Heissluftführung (44)** wird zuerst der **Schweisssschuh (8)** entfernt. Nach dem Lösen der gekonterten **Fixierschraube (45)** an der **Rohrklemme (10)** und der **Klemmschraube (47)** am Heissluftführungs-Verbinder kann die ganze Einheit abgezogen werden.

Montage in umgekehrter Reihenfolge.

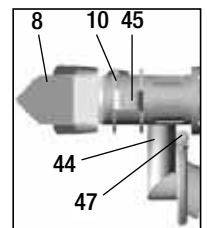

Wechsel der Vorwärmdüse

Demontage: Bei der Vorwärmdüse **Vorwärmdüse (9)** **Klemmschraube (43)** lösen und **Vorwärmdüse (9)** von der **Heissluftführung (44)** abziehen.

Montage: **Vorwärmdüse (9)** auf die **Heissluftführung (44)** schieben. Auf parallele Ausrichtung zum Düsensschuh achten. **Klemmschraube (43)** anziehen.

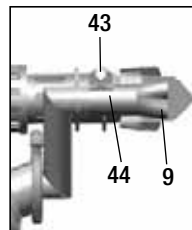

Vorwärmdüsen für Geräte mit externer Luftführung

Es stehen drei verschiedene, der Schweissnahtbreite entsprechende **Vorwärmdüsen (9)** zur Auswahl. Die Düsenquerschnitte entsprechen den DVS-Richtlinien.



Schweissschuh-Sortiment

Leister Technologies AG bietet für alle gebräuchlichen Nahtformen entsprechende Schweisssschuhe in diversen Grössen an:

WELDPLAST S2 / WELDPLAST S2-TPO mit integrierter Luftführung

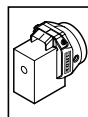

Rohling

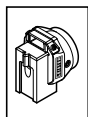

V-Naht



Kehlnaht

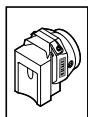

Überlapp-
naht

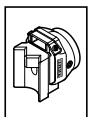

Ecknaht
aussen



Ecknaht
kurz



Ecknaht
lang

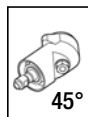

45°

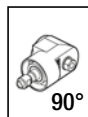

90°

Winkelkopf

WELDPLAST S2 / WELDPLAST S2-PVC mit externer Luftführung

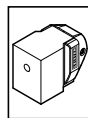

Rohling

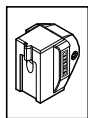

V-Naht

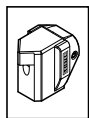

Kehlnaht



Überlapp-
naht

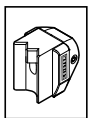

Ecknaht
aussen



Ecknaht
kurz



Ecknaht
lang

Zubehör

Aus technischen und sicherheitsrelevanten Gründen darf ausschliesslich nur Leister Zubehör verwendet werden.

Geräteablage



Transportable Drahtabrollvorrichtung

- Die Vorrichtung ist für Schweißdrahtrollen mit \varnothing 300 mm ausgelegt.
- Um eine optimale Drahtabwicklung zu gewährleisten, ist der Schweißdraht durch die dafür vorgesehene **Öse (41)** zu führen.

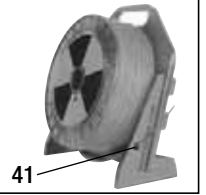

Wartung

- **Netzanschlussleitung (14)** und Stecker auf elektrische und mechanische Beschädigungen überprüfen.
- Die **Extrudierdüse (32)** bei jedem Schweißschuhwechsel von Schweißgutrückständen befreien.

Service und Reparatur

- Reparaturen sind ausschliesslich von autorisierten **Leister-Service-Stellen** ausführen zu lassen. Diese gewährleisten **innert 24 Stunden** einen fachgerechten und zuverlässigen **Reparatur-Service** mit Original-Ersatzteilen gemäss Schaltplänen und Ersatzteillisten.
- Erscheint beim WELDPLAST S2 nach dem Einschalten des Gerätes die Service-Anzeige mit dem **Service-Code 1**, sollte der Kohlestand von einer autorisierten **Leister-Service-Stelle** kontrolliert und die Antriebs-Kohlebürsten gegebenenfalls ausgewechselt werden.
- Die Anzeige kann mit der **Select-Taste (28)**  wieder ausgeblendet werden.
- Mit dem Hand-Extruder kann kurzzeitig weitergearbeitet werden.
- Werden die Kohlebürsten nicht innert nützlicher Frist ausgewechselt, läuft der Antrieb bis zum Erreichen des mechanischen Kohlenstopps. Auf der Anzeige erscheint keine Fehlermeldung, jedoch läuft der Antrieb nicht mehr an.



Gewährleistung

- Für dieses Gerät gelten die vom direkten Vertriebspartner/Verkäufer gewährten Garantie- oder Gewährleistungsrechte ab Kaufdatum. Bei einem Garantie- oder Gewährleistungsanspruch (Nachweis durch Rechnung oder Lieferschein) werden Herstellungs- oder Verarbeitungsfehler vom Vertriebspartner durch Ersatzlieferung oder Reparatur beseitigt. Heizelemente sind von der Gewährleistung oder Garantie ausgeschlossen.
- Weitere Garantie- oder Gewährleistungsansprüche werden im Rahmen des zwingenden Rechts ausgeschlossen.
- Schäden, die auf natürliche Abnutzung, Überlastung oder unsachgemässe Behandlung zurückzuführen sind, werden von der Gewährleistung ausgeschlossen.
- Keine Garantie- oder Gewährleistungsansprüche bestehen bei Geräten, die vom Käufer umgebaut oder verändert wurden.



Read the operating instructions carefully before starting the device and keep them for future reference.

Leister WELDPLAST S2 / S2-PVC / S2-TPO Hand Extruder

Application

Extrusion welding of the following materials:

WELDPLAST S2 PP / PE-HD / PE-LD
WELDPLAST S2-PVC PP / PE-HD / PE-LD / PVC-U
WELDPLAST S2-TPO PP / PE-HD / PE-LD / TPO
Other materials on enquiry

The hand extruder corresponds to the DVS standard 2207–4.

DVS: Deutscher Verband für Schweisstechnik (German Association for Welding Technology)



Warning



Opening the device is **extremely dangerous**, since live parts and connections are exposed. Remove the plug from the socket before opening the device. Electro-conductive material (e.g. PE-EL) may **not** be welded.



Danger of fire and explosion if the hand extruder is used incorrectly (e.g. overheating of material), particularly near combustible materials and explosive gases.



Danger – can cause burns! Do not touch bare metal parts and emerging material while hot. Allow the device to cool. Do not direct stream of hot air or emerging material towards people or animals.



Connect device to **power socket with protective earth conductor**. Any break in the protective earth conductor inside or outside the device is dangerous!

Only use extension cables with a protective earth conductor!



Caution



The **nominal voltage** indicated on the device must correspond to the mains voltage. If power failure occurs, the main switch and drive must be switched off (release locking device).



When using the device on building sites, a **residual current circuit breaker** is **essential for the safety** of persons there.



The device must **not be left unattended** when in use. Heat can reach combustible materials which are out of sight.

The device may only be used by **trained personnel** or under their supervision. Children may not use the device under any circumstances.



Keep away from wet and damp areas.

Conformity

Leister Technologies AG, Galileo-Strasse 10, CH-6056 Kaegiswil/Switzerland confirms that this product in the version put into circulation by us, fulfils the requirements of the following EC directives.

Directives:	2006/42 2004/108 (until 19.04.2016), 2014/30 (starting 20.04.2016) 2006/95 (until 19.04.2016), 2014/35 (starting 20.04.2016) 2011/65
Harmonised standards:	EN 12100, EN 55014-1, EN 55014-2, EN 61000-6-2, EN 61000-3-2, EN 61000-3-3, EN 62233, EN 60335-1, EN 60335-2-45, EN 50581

Kaegiswil, 04.01.2016

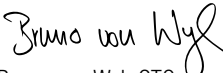
Bruno von Wyl, CTO

Andreas Kathriner, GM

Disposal



Electrical equipment, accessories and packaging should be recycled in an environmentally friendly way. **For EU countries only:** Do not dispose of electrical equipment with household refuse!

Technical Data

Voltage	V~	230	200
Power consumption	W	3000	2400
Frequency	Hz	50/60	
Air volume (20 °C)	l/min	300	
Air temperature	°C	max. 350	
Plasticizing temperature	°C	max. 260	
Output (Ø 3 mm)	kg/h	PE 0.6–1.3 PP 0.5–1.2 *PVC-U 0.9–1.7 (average values at 50 Hz)	
Output (Ø 4 mm)	kg/h	PE 1.0–2.3 PP 0.9–2.0 *PVC-U 1.5–2.7 (average values at 50 Hz)	
Filler rod	mm	Ø 3 / Ø 4	
Dimensions L × B × H	mm	450 × 98 × 260 (without welding shoe)	
Weight	kg	5.8 (without power cable)	
Conformity mark		CE	CE
Safety standard		Ⓢ	
Protection class I		Ⓢ	Ⓢ

* WELDPLAST S2-PVC

The right to make technical changes is reserved

Device Description

With external air duct

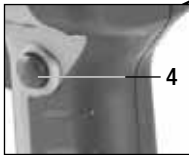
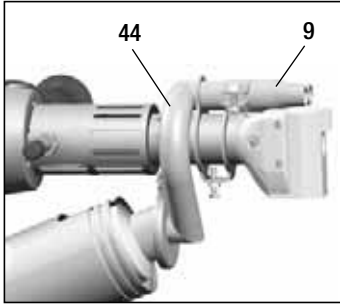

With integrated air duct

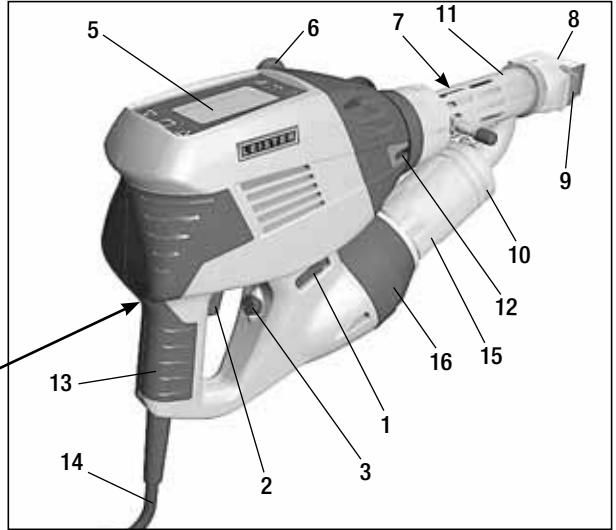

- 1 Main switch
- 2 On/off switch for drive
- 3 Potentiometer
- 4 Drive locking device
- 5 Display
- 6 Guide handle
- 7 Jacket heating
- 8 Welding shoe
- 9 Pre-heating nozzle

- 10 Pipe clip
- 11 Protection tube
- 12 Filler rod insertion point
- 13 Device grip
- 14 Power supply cord
- 15 Heating element protection tube
- 16 Hot air blower (brushless)
- 44 External hot air duct

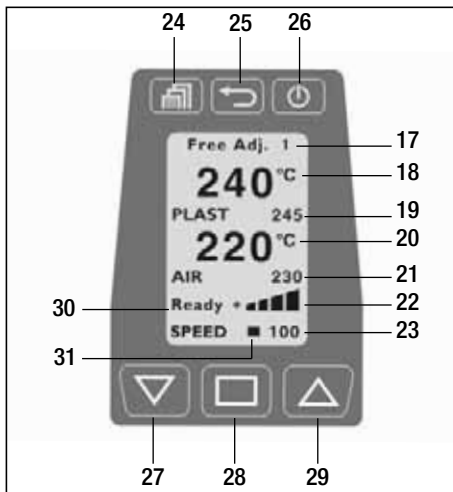

Operating unit

- 17 Welding program
- 18 Actual value - plastic
- 19 Ideal value - plastic
- 20 Actual value - air
- 21 Ideal value - air
- 22 Drive display bars
- 23 Output display
- 24 Menu key
- 25 Back key
- 26 Standby/Enter key
- 27 Down key
- 28 Select key
- 29 Up key
- 30 Drive status display
- 31 Cursor

Work environment/Safety



The hand extruder must not be used in areas where there is danger of explosion or flammable materials. Ensure a safe posture during work. The power cable and filler rod must be free to move and must not obstruct the user or third parties during work.



Place hand extruder on a fire resistant base. Hot metal parts and hot streams of air must be kept at a safe distance from the base and walls.

Setting the guide handle

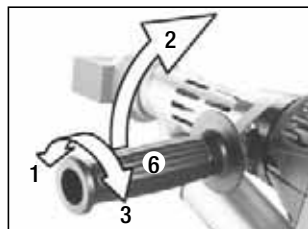

1. Loosen clamp by turning the **guide handle (6)** anti-clockwise
2. Move the **guide handle (6)** into the desired operating position
3. Tighten clamp again by turning **guide handle (6)** clockwise

Workplace



Leister provides a **universal stand** for commissioning and holding the hand extruder.



When not welding, the drive should be switched off with the **drive on/off switch (2)**.

Place the hand extruder with correspondingly set and firmly tightened handle on a stable, fireproof base as shown in the illustration.

Extension cables

Ensure the minimum cross-section when using extension cables:

The extension cable must be approved for the site of use (e.g. in the open air) and marked correspondingly.

When using a power unit for power supply, its nominal power rating is: $2 \times$ nominal power rating of the hand extruder.

Length [m]	Minimum cross-section (at 230V~) [mm ²]
Up to 19	2.5
20 – 50	4.0

Welding preparation

The temperature control prevents the hand extruder from being started while it is cold.

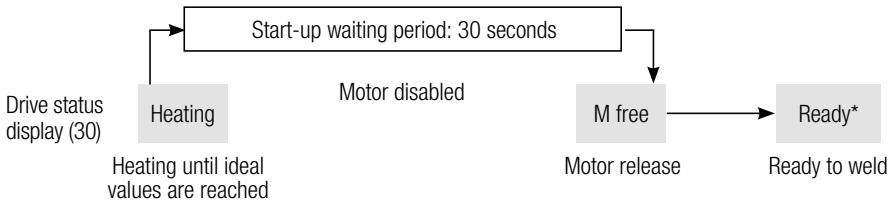

The device heats up to the last ideal temperature set directly after switching on the **main switch (1)**. When the ideal temperature is reached, a counter on the status display counts back from 30 seconds to zero. After this start-up process is complete, the device is ready to weld (status Ready*). The hand extruder takes around 4 minutes to reach its temperature range.

If the power is only turned off for a short time, the start-up process does not need to be repeated.

Software and menu guide

The hand extruder Weldplast S2 is provided with a convenient user software, making work easier for the user. Tap lightly on the keys to operate them.

	Workspace functions	Menu selection functions
	Menu selection	Menu selection / Back to workspace
	Set contrast	Back to workspace (changes not saved!)
	Heating on/off	Select and back to workspace
	Change cursor position	Select
	Selected value [+]	Cursor up / Selected value [+]
	Selected value [-]	Cursor down / Selected value [-]

Start window

After turning on the hand extruder with the **main switch (1)**, the device name and current software version will be displayed for 3 seconds.



Workspace

The workspace shows the parameters which are currently set.



Setting the parameters in the workspace

The **cursor (31)** shows which parameters can be set. After the device is switched on, the cursor is situated on «SPEED». «AIR» or «PLAST» can be selected with the **Select key (28)** and their values can be changed using the **Up key (29)** or **Down key (27)**.

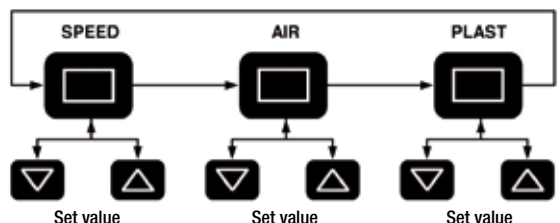

Welding preparation

Setting the output volume

The output volume and the pre-heating time can be coordinated with each other according to the type of seam.

- Presetting on the display
 - Move the cursor to the «SPEED» position by pressing the **Select key (28)**.
 - Specify the maximum output value (30-100 %) using the **Up (29)** or **Down (27)** keys (displayed on the **drive display bars (22)**).
- Precise adjustment during the welding process
 - The output volume can be reduced from the maximum set value (e.g. 85%) to the minimum by turning the **potentiometer (3)**.

The output volume is dependent on the size of filler rod used. If the output is too large when the output display is set to «30» and the potentiometer to «Minimum», the filler rod must be changed to the next size down.

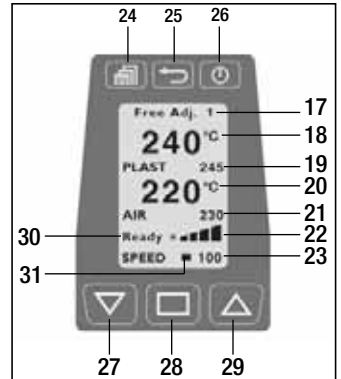

Example

Setting the PLAST and AIR temperatures

- Move the cursor to the «PLAST» or «AIR» position by pressing the **Select key (28)**.
- Set the temperature value by using the **Up (29)** or **Down (27)** key.

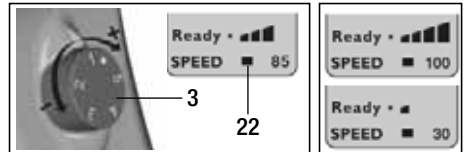

Monitoring the welding parameters

The actual and ideal values of the AIR and PLAST temperatures are constantly monitored. If an actual value deviates from the relevant ideal value (value is outside the range of tolerance), this will be indicated by a change in status on the **status display (30)**. If necessary, the drive motor will be temporarily disabled until the welding parameters are back in the specified tolerance range. The possible status display and the ranges of tolerance are shown in the following graphic and table.

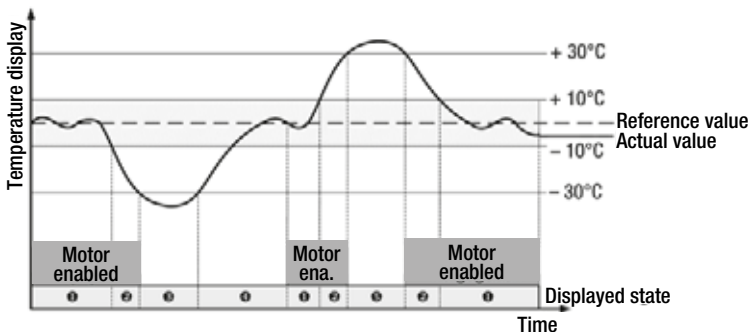

No	Status display	Status characteristics
①	Ready*	Ready to weld
②	M free	Divergence from welding parameters (plastic) > 10°C
③	Heating	Divergence from welding parameters (plastic) > - 30°C, drive motor disabled
④	30s	Start-up waiting period of 30 sec., drive motor disabled
⑤	Too hot	Divergence from welding parameters > + 30°C, drive motor disabled

Starting the welding process

- Fit the appropriate **welding shoe (8)** according to requirements.
- Set **potentiometer (3)** to max.
- When the operating temperature has been reached (Status Ready*), welding can begin.
- Press **on/off switch for the drive (2)**.
- Feed filler rod with a diameter of 3 or 4 mm into the **filler rod insertion point (12)**.
- The filler rod will be automatically pulled through the **filler rod insertion point (12)**. The rod feed must take place without resistance.



WARNING!

Always operate device with filler rod, but never feed filler rod into both filler rod insertion points at the same time.

- Pause the delivery of material with the **on/off switch for the drive (2)**.
- Direct the **pre-heating nozzle (9)** onto the area to be welded.
- Warm the area to be welded with oscillating movements.
- Attach the device to the prepared welding area and press the **drive on/off switch (2)** again.
- Carry out a test weld according to the welding instruction of the material manufacturer and national standards or guidelines.
- Check the test weld.
- Adjust temperature settings and output amount according to requirements.
- During a longer period of welding, the **on/off switch for the drive (2)** can be kept in continuous operation using the **drive locking device (4)**.

WELDPLAST S2 - PVC

- PVC-U may only be processed in the PVC-U menu. WARNING: Only use PVC-U (not PVC-C).
- To prevent corrosion, if the machine is not going to be used for a longer period of time (more than 2 days) it is recommended to fill it with HD-PE.

Welding parameters

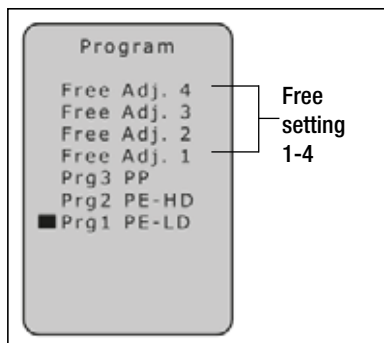
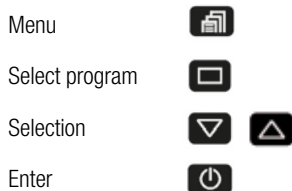

Program: the display of the materials may vary according to the machine and software versions.

Programs 1-3 are provided with preset parameters which can be adjusted during the welding process. The adjustments are not saved!

The free settings 1-4 are preset in the factory and can be programmed freely. The parameters are saved even after the device has been switched off.

Welding program	Ideal PLAST [°C]	Ideal AIR [°C]
Free set 1 – 4	230	260
Prg1 PE-LD	220	260
Prg2 PE-HD	230	260
Prg3 PP	240	260
Prg0 PVC-U	200	300

The **welding program (17)** which is currently set can be seen in the workspace. The display of the materials may vary according to the machine and software versions.

Setting the output volume

- Move the cursor to the «SPEED» position by pressing the **Select key (28)**.
- Set the output value (30-100 %) by using the **Up (29)** or **Down (27)** key.

Setting the PLAST and AIR temperature

- Move the cursor to the «PLAST» or «AIR» position by pressing the **Select key (28)**.
- Set the temperature value by using the **Up (29)** or **Down (27)** key.

Turning the device off

- Release **drive locking device (4)** and let go of the **on/off switch for the drive (2)**
Remove welding material in the welding shoe, so that the welding shoe will not be damaged the next time the device is started up.
- Turn off the heating with the **Standby/Enter key (26)**.
- Allow device to cool down for approx. 5 minutes.
- Turn off **main switch (1)**.

Additional settings



Contrast setting

In unfavourable lighting conditions and with ambient temperature fluctuations, the contrast can be set by using the **Back key (25)**.

Heating ON/OFF

During a longer period on standby, the heating for PLAST and AIR can be switched off using the **Standby/Enter key (26)**.

Activate key lock

1. Menu 
2. Key lock 
3. Activating 

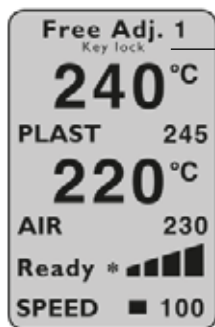

If the keypad is locked, **'key lock'** will appear in the display.



Key lock activated









The lock is released as follows:

Deactivate key lock

1. Back 
2. Reset 
3. Select 

The reset must be confirmed by pressing the Select key immediately!

Menu guide

Menu	Functions
Menu 	Selection  
Selection  	Select and Back 
Select 	Back to workspace selection 

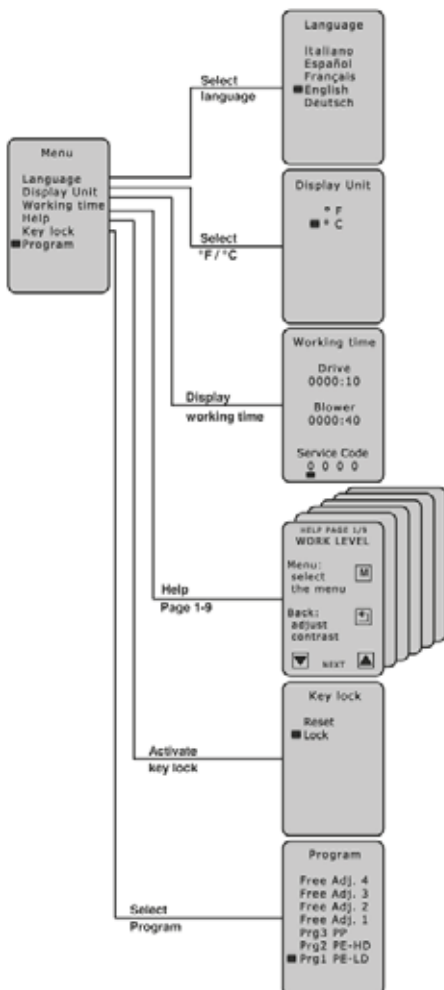

Error messages

If an error occurs, this will be shown in the **status display (30)** (e.g. **Err04** Motor overheated).

Display **ErrXX**

If an error occurs, the heating for AIR and PLAST and the drive motor will be switched off immediately. If this does not happen, the device should be disconnected from the power supply immediately!

How to proceed with the status display of the drive (30) **ErrXX**

- Note error code.
- Release **drive locking device (4)** and let go of the **on/off switch for the drive (2)**.
- Turn off **main switch (1)**.
- Operate the device again, monitoring it carefully, and make sure that the hand extruder is not being overheated from external sources.
- If possible, expel the plastic remaining in the screw.
- If the error occurs again, the device should be sent to the service point for inspection, with a note of the error code.

The following errors are recognised by the device:

Display	Type of error
Err01	Air temperature too high or defective temperature sensor
Err02	Plastic temperature too high or defective temperature sensor
Err04	Engine coil temperature too high, motor has overheated
Err08	Heating element AIR temperature too high or blower motor has failed
Err10	Electronics temperature too high
Err40	Short circuit in PLAST temperature sensor

If several errors occur simultaneously, e.g. **Err02** and **Err04**, **Err06** will be displayed.

Further combinations are shown with the letters A, B, C, D, E and F, e.g. **Err08** and **Err02** Display **Err0A**.

Overheating protection for the drive

If the drive is overheated by external influences or a PLAST temperature which is too low, the internal protection against excessive temperatures will turn the drive off (see **Err04**).

Accidental start-up protection for the drive

The drive motor is protected against accidental start-up after errors, e.g. overheating **Err04**. The message «Switch off drive» appears in the **display (5)** while the drive motor is disabled. After correcting the error and switching off the drive (release **drive locking device (4)** and let go of the **on/off switch for the drive (2)**), the message «Switch off drive» will disappear in the **Display (5)**. Welding may continue.

Replacing accessories



Danger – can cause burns!



Only work with heat-resistant gloves.

Changing the welding shoe

The welding shoe must be changed while the device is still warm from operation.

Disassembly

- Turn off the device while warm and disconnect from the power supply.
- Remove the **welding shoe (8)** with the **welding shoe holder (34)** by unfastening the **clamp screws (35)** from the **extruder nozzle (32)**.
- Every time the welding shoe is changed, clean the **extruder nozzle (32)** of welding residue and make sure that it is screwed in tightly.
- Remove **welding shoe (8)** from the **welding shoe holder (34)** by unfastening the **fastening screws (33)**.

Assembly

- Fasten a **welding shoe (8)**, appropriate to the welding seam, onto the **welding shoe holder (34)** with **fastening screws (33)**.
- The **welding shoe (8)** and **welding shoe holder (34)** must be tightened properly with the **clamp screws (35)**.

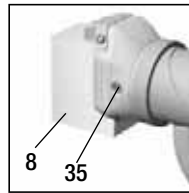
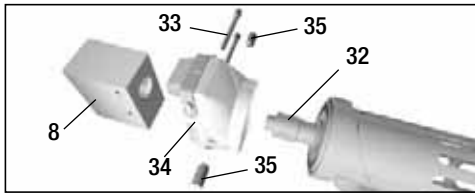

- 8 Welding shoe
- 32 Extruder nozzle
- 33 Fastening screw
- 34 Welding shoe holder
- 35 Clamp screw

Welding direction

The **welding shoe (8)** can be turned infinitely to the desired welding direction by loosening the **clamp screws (35)**.

The **clamp screws (35)** must be tightened well again afterwards.

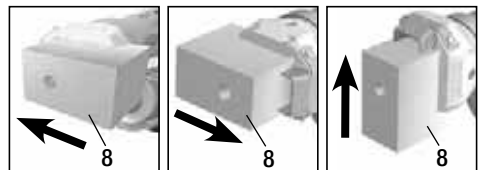

Changing the hot air duct

To disassemble the **hot air duct (44)**, first remove the **welding shoe (8)**. After loosening the locked **fastening screw (45)** on the **pipe clip (10)** and the **clamp screw (47)** on the hot air duct connector, the entire unit can be pulled out.

Assembly in reverse order.

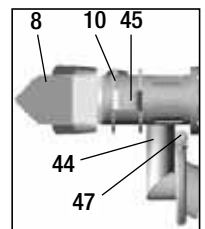

Changing the pre-heating nozzle

Disassembly: For the **pre-heating nozzle (9)**, **unscrew clamp screw (43)** and pull **pre-heating nozzle (9)** off the **hot air duct (44)**.

Assembly: Push **pre-heating nozzle (9)** onto the **hot air duct (44)**.
Make sure that it is aligned parallel to the nozzle shoe.
Tighten **clamp screw (43)**.

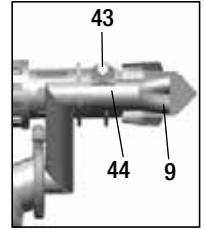

Pre-heating nozzles for extruders with external air duct

Three different **pre-heating nozzles (9)** corresponding to the weld seam width are available. The nozzle cross sections correspond to the DVS guidelines.



Welding shoe range

Leister Technologies AG offers the right welding shoes for all common types of seam in various sizes:

WELDPLAST S2 / WELDPLAST S2-TPO with integrated air duct

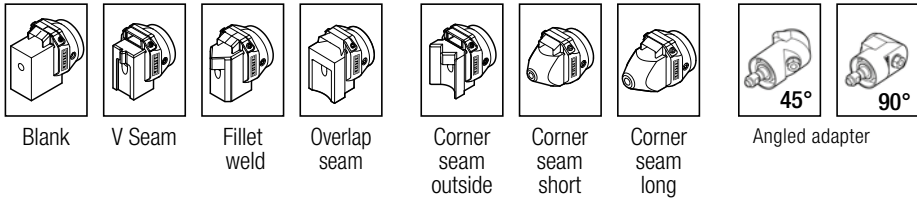

WELDPLAST S2 / WELDPLAST S2-PVC with external air duct

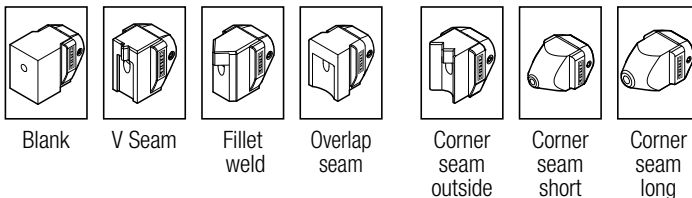

Accessories

Only **Leister accessories** may be used.

Stand



Transportable welding rod de-reeler

- The de-reeler is designed for rolls of welding rod with \varnothing 300 mm.
- To ensure that the filler rod is unwound as smoothly as possible, it should be fed through the specially designed **eyes (41)**.

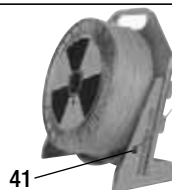

41

Maintenance

- Check **power supply cord (14)** and plug for electrical and mechanical damage.
- Clean the **extruder nozzle (32)** of welding residue every time the welding shoe is changed.

Service and Repairs

- Repairs should only be carried out by authorised **Leister service points**. These guarantee a professional, reliable **repair service within 24 hours**, using original replacement parts according to the circuit diagrams and replacement part lists.
- If a service message with the **service code 1** appears after the WELDPLAST S2 is turned on, the carbon level should be checked by an authorised **Leister service point** and, if necessary, the carbon brushes of the drive changed.
- The message can be hidden by pressing the **Select key (28)** .
- The hand extruder may continue to be operated for a short time.
- If the carbon brushes are not exchanged in good time, the drive will operate until it reaches the mechanical carbon shut-off point. No error message will appear on the display, but the drive will no longer operate.



Warranty

- For this tool, the guarantee or warranty rights granted by the relevant distributor/seller shall apply. In case of guarantee or warranty claims any manufacturing or workmanship defects will either be repaired or replaced by the distributor at its discretion. Warranty or guarantee rights have to be verified by an invoice or a delivery document. Heating elements shall be excluded from warranty or guarantee.
- Additional guarantee or warranty claims shall be excluded, subject to mandatory provisions of law.
- Warranty or guarantee shall not apply to defects caused by normal wear and tear, overload or improper handling.
- Warranty or guarantee claims will be rejected for tools that have been altered or changed by the purchaser.



Lisez attentivement la notice d'utilisation avant de mettre l'appareil en service et conservez-la à disposition pour une consultation ultérieure.

Leister WELDPLAST S2 / S2-PVC / S2-TPO Extrudeuse manuelle

Application

Soudage par extrusion des matériaux suivants :

WELDPLAST S2 PP / PE-HD / PE-LD
WELDPLAST S2-PVC PP / PE-HD / PE-LD / PVC-U
WELDPLAST S2-TPO PP / PE-HD / PE-LD / TPO
Autres matériaux sur demande

De l'extrudeuse manuelle satisfait à la norme DVS 2207-4.

DVS: Deutscher Verband für Schweisstechnik (Association allemande du soudage et des procédés apparentés)



Avertissement



Danger de mort à l'ouverture de l'appareil, car des composants et des liaisons sous tension sont découverts. Avant d'ouvrir l'appareil, retirez la fiche secteur de la prise de courant. Les matériaux électro-conducteurs (comme par exemple le PE-EL) ne doivent pas être soudés.



Risque d'incendie et d'explosion en cas d'utilisation non conforme de l'extrudeuse manuelle (par exemple en cas de surchauffe du matériau), en particulier à proximité de matériaux inflammables et de gaz explosifs.



Risque de brûlure ! Ne touchez pas les pièces métalliques nues et la masse extrudée si elles sont chaudes. Laissez refroidir l'appareil. Ne dirigez pas le jet d'air chaud ni la masse extrudée sur les personnes ou les animaux.



Raccordez l'appareil à une prise de courant équipée d'un **conducteur de protection**. Toute rupture du conducteur de protection à l'intérieur ou à l'extérieur de l'appareil est dangereuse !

Utilisez exclusivement un câble de prolongation équipé d'un conducteur de protection !



Attention



La **tension nominale** indiquée sur l'appareil doit correspondre à la tension du secteur. En cas de panne de courant, le commutateur principal et l'entraînement doivent être mis hors tension (déblocage du dispositif d'arrêt).



Un **interrupteur FI** est **absolument nécessaire** pendant l'utilisation de l'appareil sur des chantiers pour assurer la protection des personnes.



L'appareil doit fonctionner sous **supervision**. La chaleur peut atteindre des matériaux inflammables se trouvant hors de portée de vue. L'appareil doit être utilisé exclusivement par des **spécialistes formés** ou sous leur supervision. L'utilisation de l'appareil par des enfants est strictement interdite.



Protégez l'appareil de l'humidité et de la pluie.

Conformité

Leister Technologies AG, Galileo-Strasse 10, CH-6056 Kaegiswil/Suisse atteste que ce produit, dans la version que nous avons mise en circulation, satisfait aux exigences des directives CE suivantes.

Directives :	2006/42 2004/108 (jusqu'au 19.04.2016), 2014/30 (à partir du 20.04.2016) 2006/95 (jusqu'au 19.04.2016), 2014/35 (à partir du 20.04.2016) 2011/65
Normes harmonisées :	EN 12100, EN 55014-1, EN 55014-2, EN 61000-6-2, EN 61000-3-2, EN 61000-3-3, EN 62233, EN 60335-1, EN 60335-2-45, EN 50581

Kaegiswil, 04.01.2016

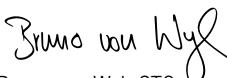
Bruno von Wyl, CTO

Andreas Kathriner, GM

Elimination



Les outils électriques, les accessoires et les emballages doivent être recyclés en respectant l'environnement. **Pour les pays de l'UE uniquement** : ne pas jeter les outils électriques avec les déchets ménagers !

Caractéristiques techniques

Tension	V~	230	200
Puissance	W	3000	2400
Fréquence	Hz	50/60	
Débit d'air (20 °C)	l/min	300	
Température de l'air	°C	max. 350	
Température de plastification	°C	max. 260	
Débit (Ø 3 mm)	kg/h	PE 0.6–1.3 PP 0.5–1.2 *PVC-U 0.9–1.7 (valeurs moyennes à 50 Hz)	
Débit (Ø 4 mm)	kg/h	PE 1.0–2.3 PP 0.9–2.0 *PVC-U 1.5–2.7 (valeurs moyennes à 50 Hz)	
Cordon de soudure	mm	Ø 3 / Ø 4	
Dimensions L × l × H	mm	450 × 98 × 260 (sans patin de soudage)	
Poids	kg	5.8 (sans câble d'alimentation secteur)	
Marque de conformité	CE		CE
Signe de sécurité	⊕		
Classe de protection I	⊕		⊕

* WELDPLAST S2-PVC

Sous réserve de modifications techniques

Description de l'appareil

Avec conduit d'aération externe

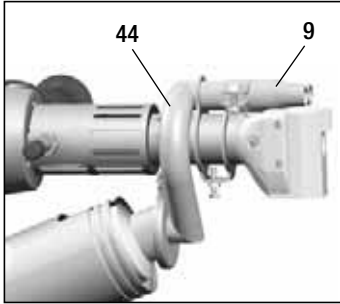

Avec conduit d'aération intégré

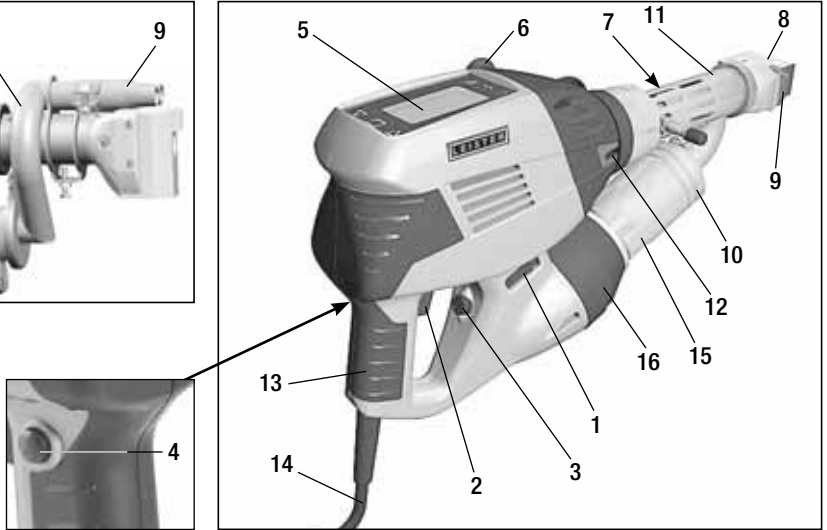

- 1 Commutateur principal
- 2 Interrupteur marche/arrêt de l'entraînement
- 3 Potentiomètre
- 4 Dispositif d'arrêt de l'entraînement
- 5 Ecran
- 6 Poignée
- 7 Chauffage de la chemise
- 8 Patin de soudage
- 9 Buse de préchauffage

- 10 Bride pour tuyau
- 11 Fourreau de protection
- 12 Orifice pour cordon de soudure
- 13 Poignée de l'appareil
- 14 Câble d'alimentation secteur
- 15 Fourreau de protection avec élément chauffant
- 16 Soufflerie à air chaud (sans collecteur)
- 44 Conduite d'air chaud externe

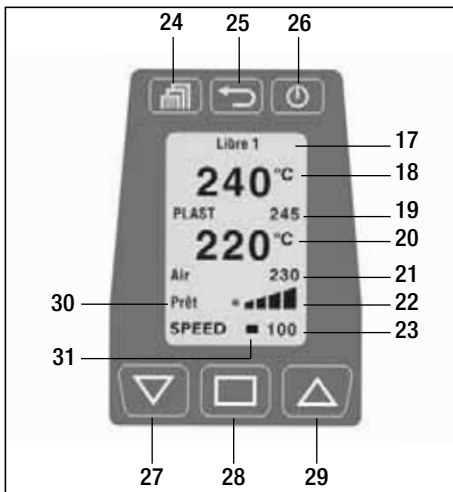

Unité de commande

- 17 Programme de soudage
- 18 Valeur réelle Plast
- 19 Valeur de consigne Plast
- 20 Valeur réelle Air
- 21 Valeur de consigne Air
- 22 Barre d'affichage de l'entraînement
- 23 Affichage du débit
- 24 Touche Menu
- 25 Touche Retour
- 26 Touche Veille/Entrée
- 27 Touche vers le bas
- 28 Touche de sélection
- 29 Touche vers le haut
- 30 Affichage de l'état de l'entraînement
- 31 Curseur

Environnement de travail / Sécurité



L'extrudeuse manuelle ne doit pas être utilisée dans un milieu où il existe un risque d'explosion ou dans un environnement inflammable. Veillez à garder une position stable pendant les travaux. Le câble d'alimentation secteur et le cordon de soudure doivent toujours être mobiles et ne doivent pas gêner l'utilisateur ou une tierce personne pendant les travaux.



Déposez l'extrudeuse manuelle sur une surface résistante au feu ! Les pièces métalliques chaudes et le jet d'air chaud doivent être suffisamment éloignés de la surface et des murs.

Réglage de la poignée

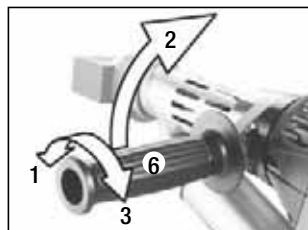

1. Desserrez le dispositif de serrage en tournant la **poignée (6)** dans le sens inverse des aiguilles d'une montre
2. Placez la **poignée (6)** dans la position de travail souhaitée
3. Bloquez à nouveau le dispositif de serrage en tournant la **poignée (6)** dans le sens des aiguilles d'une montre

Poste de travail



Pour la mise en service et le rangement de l'extrudeuse manuelle, Leister propose un **repositoir pour outils universel**.

En cas d'interruption des travaux de soudage, l'entraînement doit être mis hors tension à l'aide de l'interrupteur **marche/arrêt de l'entraînement (2)**. Déposez l'extrudeuse manuelle sur une surface stable et résistante au feu, avec la poignée correctement réglée et serrée, conformément à l'image.

Câble de prolongation

En cas d'utilisation de câbles de prolongation, une section minimale doit être respectée :

Le câble de prolongation doit être homologué pour le lieu d'exploitation (par exemple à l'air libre) et porter les marquages correspondants.

En cas d'utilisation d'un groupe électrogène pour alimenter l'appareil, la puissance nominale du groupe doit être :
2 x puissance nominale de l'extrudeuse manuelle.

Longueur [m]	Section minimale (à 230 V~) [mm ²]
Jusqu'à 19	2.5
20 – 50	4.0

Préparation de soudage

La régulation de la température empêche le démarrage à froid de l'extrudeuse manuelle.

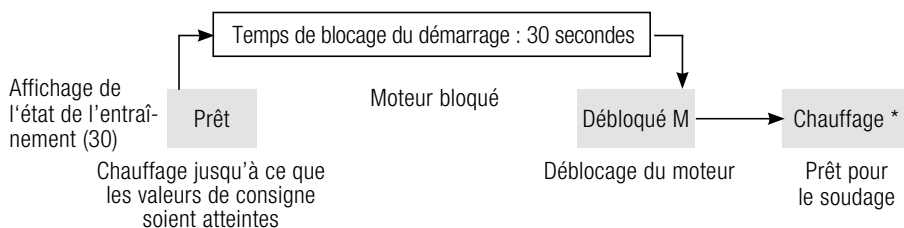

L'appareil chauffe aux températures de consigne réglées en dernier immédiatement après l'activation du **commutateur principal (1)**. Si les températures de consigne sont atteintes, le compteur affiche un compte à rebours de 30 secondes jusqu'à zéro sur l'affichage de l'état. A la fin de cette procédure de démarrage, l'appareil est prêt pour le soudage (état Prêt*). L'extrudeuse manuelle atteint sa température de service au bout d'environ 4 minutes.

En cas de coupure secteur temporaire, aucune nouvelle procédure de démarrage n'est exécutée.

Logiciel et guidage par menu

L'extrudeuse manuelle Weldplast S2 est dotée d'un logiciel utilisateur convivial qui facilite le travail de l'utilisateur. Les touches sont activées d'un simple effleurement.

	Fonctions de la fenêtre de travail	Fonctions de la sélection du menu
	Sélection du menu	Sélection du menu / Retour à la fenêtre de travail
	Réglage du contraste	Retour à la fenêtre de travail (les modifications ne sont pas enregistrées !)
	Marche/arrêt du chauffage	Sélectionner et retour à la fenêtre de travail
	Modifier la position du curseur	Sélectionner
	Valeur sélectionnée [+]	Curseur vers le haut / Valeur sélectionnée [+]
	Valeur sélectionnée [-]	Curseur vers le bas / Valeur sélectionnée [-]

Fenêtre de démarrage

Après la mise sous tension de l'extrudeuse manuelle à l'aide du **commutateur principal (1)**, le nom de l'appareil et la version actuelle du logiciel s'affichent pendant 3 secondes à l'écran.



Fenêtre de travail

La fenêtre de travail affiche les paramètres actuellement définis.

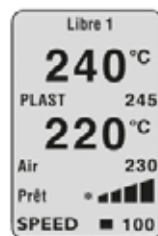

Réglage des paramètres dans la fenêtre de travail

Le **curseur (31)** indique quel paramètre peut être réglé. Après la mise sous tension, le curseur se trouve sur la position « SPEED ». Avec la **touche de sélection (28)**, vous pouvez sélectionner « AIR » ou « PLAST » et modifier les valeurs à l'aide de la **touche vers le haut (29)** ou de la **touche vers le bas (27)**.

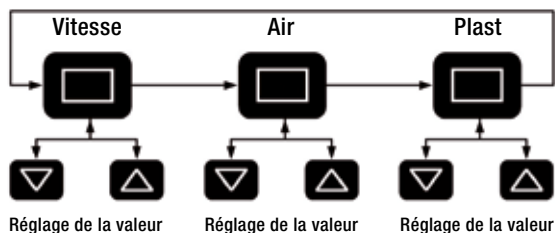

Préparation de soudage

Réglage du débit

En raison de la forme du cordon, le débit et la durée de préchauffage peuvent être coordonnés entre eux.

- Préréglage à l'écran
 - En appuyant sur la **touche de sélection (28)**, placez le curseur sur la position « SPEED ».
 - Fixez la valeur maximale du débit (30 à 100 %) à l'aide de la **touche vers le haut (29)** ou de la **touche vers le bas (27)** (elle est représentée par la **barre d'affichage de l'entraînement (22)**)
- Réglage précis pendant la procédure de soudage
 - A partir de la valeur maximale du débit définie (par exemple 85 %), vous pouvez réduire le débit au minimum en tournant le **potentiomètre (3)**

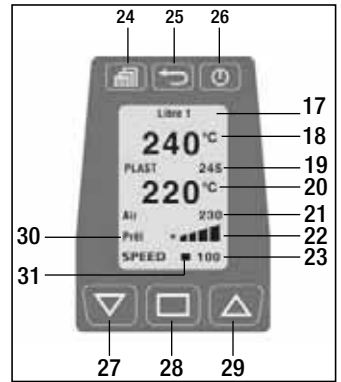

Le débit dépend de l'épaisseur du cordon de soudure utilisé. Si le débit est trop élevé avec un débit affiché à « 30 » et le potentiomètre réglé sur « Minimum », vous devez sélectionner l'épaisseur immédiatement inférieure du cordon de soudure.

Réglage des températures PLAST et AIR

- En appuyant sur la **touche de sélection (28)**, placez le curseur sur la position « PLAST » ou « AIR »
- Réglez la valeur de la température à l'aide de la **touche vers le haut (29)** ou de la **touche vers le bas (27)**

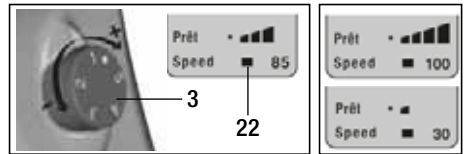

Exemple

Contrôle des paramètres de soudage

Les valeurs de consigne et valeurs réelles des températures AIR et PLAST sont contrôlées en permanence. La déviation d'une valeur réelle par rapport à la valeur de consigne correspondante (la valeur se situe en dehors de la bande de tolérance) est signalée sur l'affichage de l'état (30) par un changement de statut. Si nécessaire, le moteur d'entraînement est bloqué temporairement, jusqu'à ce que les paramètres de soudage se trouvent à nouveau dans la bande de tolérance prédéfinie. Les affichages de l'état possibles et les bandes de tolérance sont visibles sur le graphique ou dans le tableau suivant.

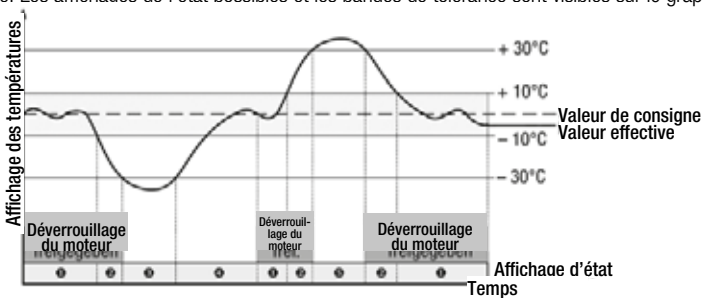

N°	Affichage de l'état	Définitions de l'état
❶	Prêt*	Prêt pour le soudage
❷	Débloqué M	Déviations des paramètres de soudage (plastique) > 10 °C
❸	Chauffage	Déviations des paramètres de soudage (plastique) > - 30 °C, moteur d'entraînement bloqué
❹	30s	Temps de blocage du démarrage de 30 s, moteur d'entraînement bloqué
❺	trop chaud	Déviations des paramètres de soudage > + 30 °C, moteur d'entraînement bloqué

Démarrage de la procédure de soudage

- Si nécessaire, montez le **patin de soudage (8)** correspondant
- Réglez le **potentiomètre (3)** sur le maximum
- Si la température de service est atteinte (état Bereit*), le soudage peut commencer
- Actionnez l'**interrupteur marche/arrêt de l'entraînement (2)**
- Insérez le cordon de soudure d'un diamètre de 3 ou 4 mm dans l'**orifice pour cordon de soudure (12)**
- Le cordon de soudure est rentré automatiquement à travers l'**orifice pour cordon de soudure (12)**.
L'insertion du cordon doit s'effectuer sans résistance



ATTENTION !





Faites toujours fonctionner l'appareil avec un cordon de soudure, mais n'introduisez jamais de cordon de soudure dans les deux orifices pour cordon de soudure en même temps.

- Interrompez la sortie de la masse à l'aide de l'**interrupteur marche/arrêt de l'entraînement (2)**
- Dirigez la **buse de préchauffage (9)** sur la zone de soudage
- Préchauffez la zone de soudage en effectuant des mouvements de va-et-vient
- Placez l'appareil sur la zone de soudage préparée et actionnez à nouveau l'**interrupteur marche/arrêt de l'entraînement (2)**
- Procédez à un essai de soudage conformément aux instructions de soudage du fabricant de matériaux et aux normes ou directives nationales
- Contrôlez l'essai de soudage
- Si nécessaire, adaptez le réglage de la température et du débit
- En cas de soudage prolongé, l'**interrupteur marche/arrêt de l'entraînement (2)** peut être bloqué en position de fonctionnement à l'**aide du dispositif d'arrêt de l'entraînement (4)**

WELDPLAST S2 - PVC

- PVC-U ne doit être traité que dans le menu PVC-U. ATTENTION: Utilisez uniquement PVC-U (pas PVC-C !)
- Pour éviter tout risque de corrosion, il est conseillé de remplir l'appareil de HD-PE en cas de non-utilisation prolongée (à partir de 2 jours).

Paramètres de soudage

- Menu 
- Sélectionner un programme 
- Sélection  
- Entrée 

Programme : l'affichage des matériaux peut varier selon la version de l'appareil et du logiciel.

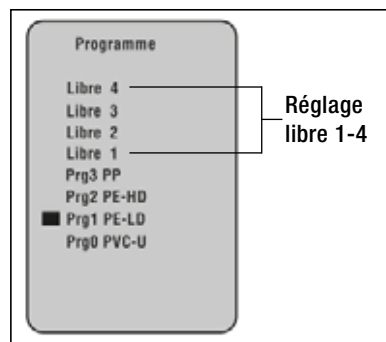

Les programmes 1 – 3 sont dotés de paramètres prédéfinis qui peuvent être adaptés pendant la procédure de soudage.

Les modifications ne sont pas enregistrées !

Les réglages libres 1 – 4 sont prédéfinis en usine et peuvent être programmés librement. Les paramètres restent en mémoire même après la mise hors tension de l'appareil.

Programme de soudage	Valeur de consigne PLAST [°C]	Valeur de consigne AIR [°C]
Régl. libre 1 – 4	230	260
Prg1 PE-LD	220	260
Prg2 PE-HD	230	260
Prg3 PP	240	260
Prg0 PVC-U	200	300

Le **programme de soudage (17)** actuellement sélectionné est visible dans la fenêtre de travail. L'affichage des matériaux peut varier selon la version de l'appareil et du logiciel.

Réglage du débit

- En appuyant sur la **touche de sélection (28)**, placez le curseur sur la position « SPEED »
- Réglez le débit (30 à 100 %) à l'aide de la **touche vers le haut (29)** ou de la **touche vers le bas (27)**

Réglage des températures PLAST et AIR

- En appuyant sur la **touche de sélection (28)**, placez le curseur sur la position « PLAST » ou « AIR »
- Réglez la valeur de la température à l'aide de la **touche vers le haut (29)** ou de la **touche vers le bas (27)**

Mise hors tension de l'appareil

- Débloquez le dispositif d'**arrêt de l'entraînement (4)** et relâchez l'**interrupteur marche/arrêt de l'entraînement (2)**. Retirez la matière de soudure du patin de soudage pour éviter tout endommagement du patin de soudage à la prochaine mise en marche de l'appareil.
- Mettez les chauffages hors tension à l'**aide de la touche Veille/Entrée (26)**
- Laissez refroidir l'appareil pendant env. 5 minutes
- Mettez le **commutateur principal (1)** hors tension

Autres réglages



Réglage du contraste

En cas de luminosité inadaptée et de variations de la température ambiante, le contraste peut être réglé à l'aide de la touche Retour (25).

Chauffage Marche/Arrêt

En cas d'interruption prolongée du travail (mode Veille), le chauffage pour PLAST et AIR peut être mis hors tension à l'aide de la touche Veille/Entrée (26).

Activer le verrouillage des touches

1. Menu 
2. Verrouillage des touches 
3. Activer 

Si le verrouillage des touches a été activé, « **verrouillage des touches** » s'affiche sur l'écran.

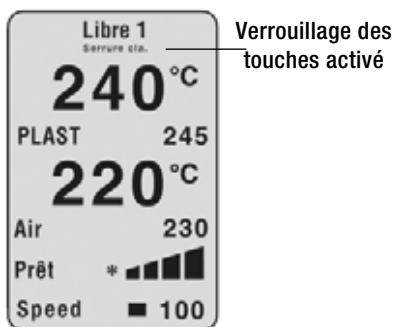

Le verrouillage peut être réinitialisé comme suit :

Désactiver le verrouillage des touches

1. Retour 
2. Retour 
3. Sélectionner 

La confirmation par le biais de la touche de sélection doit être effectuée immédiatement après avoir appuyé la touche Retour (2.) !

Guidage par menu

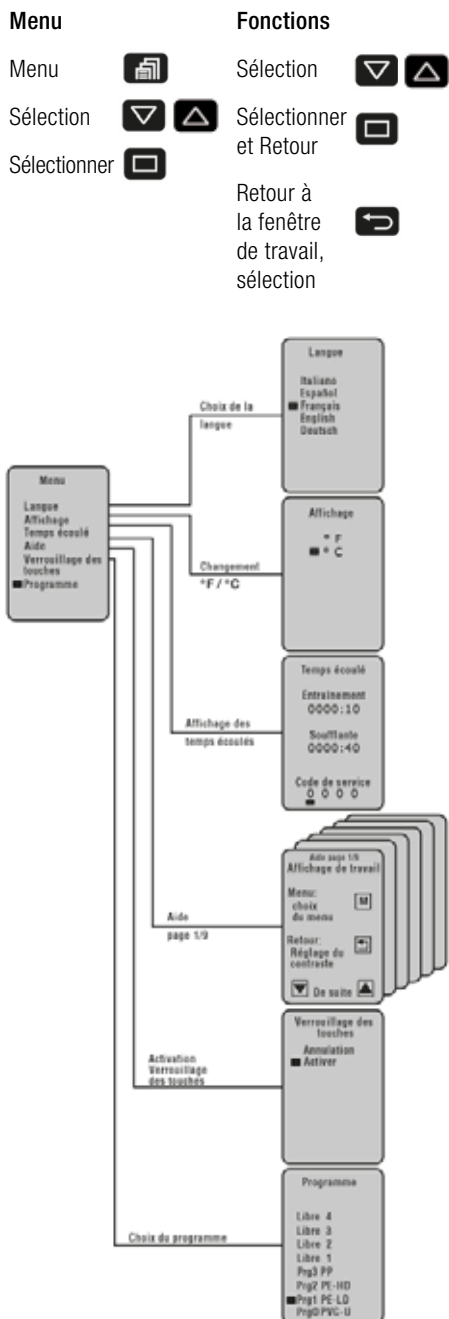

Messages d'erreur

Si une erreur se produit, elle est affichée dans l'**affichage de l'état (30)** (par exemple **Err04** Le moteur a surchauffé).

Affichage **ErrXX**

En cas d'erreur, les chauffages pour AIR et PLAST ainsi que le moteur d'entraînement doivent être immédiatement mis hors tension !

Si ce n'est pas le cas, l'appareil doit être immédiatement débranché du secteur !

Procédure à suivre si **ErrXX** apparaît dans l'affichage de l'état de l'entraînement (30)

- Relevez le code d'erreur
- Débloquez le dispositif d'**arrêt de l'entraînement (4)** et relâchez l'**interrupteur marche/arrêt de l'entraînement (2)**
- Mettez le **commutateur principal (1)** hors tension
- Refaites fonctionner l'appareil sous supervision et veillez à ce que l'extrudeuse manuelle ne soit pas soumise à une surchauffe de l'extérieur
- Si possible, éjectez le plastique resté dans la vis
- Si l'erreur se produit à nouveau, envoyez l'appareil au SAV pour le faire contrôler, en indiquant le code d'erreur

Les erreurs suivantes sont reconnues par l'appareil :

Affichage	Type d'erreur
Err01	Température excessive de l'air ou sonde de température défectueuse
Err02	Température excessive de la masse de plastique ou sonde de température défectueuse
Err04	Température excessive dans les bobines du moteur, le moteur a surchauffé
Err08	Température excessive de l'élément chauffant AIR ou moteur de soufflerie défectueux
Err10	Température excessive de l'électronique
Err40	Court-circuit au niveau de la sonde de température PLAST

Si plusieurs erreurs se produisent simultanément, par exemple **Err02** et **Err04**, **Err06** s'affiche.

D'autres combinaisons d'erreurs sont affichées à l'aide des lettres A, B, C, D, E et F, par exemple **Err08** et **Err02** : affichage de **Err0A**.

Protection de l'entraînement contre la surchauffe

Si l'entraînement subit une surchauffe en raison d'influences extérieures ou en cas de température PLAST trop basse, la protection de la température interne met l'entraînement hors tension (voir **Err04**).

Protection anti-redémarrage de l'entraînement

Le moteur d'entraînement est protégé contre un démarrage automatique après l'apparition d'erreurs, par exemple surchauffe **Err04**. Sur l'**écran (5)**, le message « Antrieb ausschalten » (Mettre l'entraînement hors tension) apparaît, tandis que le moteur d'entraînement s'arrête et reste à l'état bloqué. Une fois l'erreur supprimée et l'entraînement mis hors tension (débloquez le dispositif d'**arrêt de l'entraînement (4)** et relâchez l'**interrupteur marche/arrêt de l'entraînement (2)**), le message « Antrieb ausschalten » disparaît de l'**écran (5)**. Vous pouvez poursuivre le travail.

Changement d'accessoires



Risque de brûlure !



Travaillez uniquement avec des gants résistants aux écarts de température.

Remplacement du patin de soudage

Le remplacement du patin de soudage doit être effectué pendant que l'appareil se trouve à sa température de service.

Démontage

- Mettez l'appareil chaud hors tension et débranchez-le du secteur
- Retirez le **patin de soudage (8)** et son **support (34)** en desserrant les **vis de blocage (35)** de la **buse d'extrusion (32)**
- A chaque remplacement du patin de soudage, nettoyez la **buse d'extrusion (32)** pour enlever les résidus de matière de soudage et assurez-vous qu'elle est vissée à fond
- Retirez le **patin de soudage (8)** en desserrant les **vis de fixation (33)** du **support du patin de soudage (34)**

Montage

- Montez un **patin de soudage (8)** adapté au cordon de soudure sur le **support du patin de soudage (34)** à l'aide des **vis de fixation (33)**
- Le **patin de soudage (8)** et son **support (34)** doivent être correctement fixés au moyen des **vis de blocage (35)**

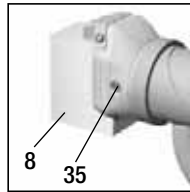
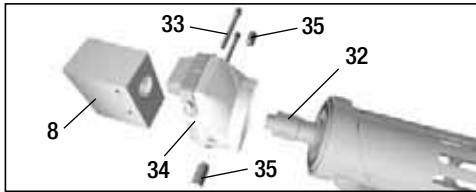

- 8 Patin de soudage
- 32 Buse d'extrusion
- 33 Vis de fixation
- 34 Support du patin de soudage
- 35 Vis de blocage

Sens de soudage

Si vous desserrez les **vis de blocage (35)**, le **patin de soudage (8)** peut être orienté librement dans le sens de soudage souhaité.

Les **vis de blocage (35)** doivent ensuite être à nouveau serrées à fond.

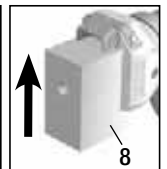
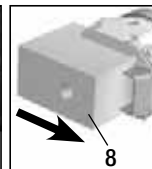
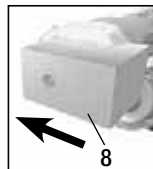

Remplacement de la conduite d'air chaud

Pour le démontage de la **conduite d'air chaud (44)**, retirez tout d'abord le **patin de soudage (8)**. Une fois que la **vis de fixation (45)** bloquée par contre-écrou est desserrée au niveau de la **bride pour tuyau (10)** et de la **vis de blocage (47)** sur le raccord de la conduite d'air chaud, l'unité complète peut être retirée.

Le montage s'effectue dans l'ordre inverse.

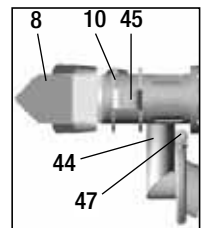

Remplacement de la buse de préchauffage

Démontage : Desserrez la **vis de blocage (43)** de la **buse de préchauffage (9)** et retirez la **buse de préchauffage (9)** de la **conduite d'air chaud (44)**.

Montage : Poussez la **buse de préchauffage (9)** sur la **conduite d'air chaud (44)**. Veillez à l'ajustement parallèle par rapport au patin de la buse. Vissez la **vis de blocage (43)**.

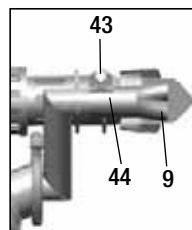

Buses de préchauffage pour les appareils avec conduit d'aération externe

Trois **buses de préchauffage (9)** différentes adaptées à la largeur du cordon de soudure sont disponibles. Les sections des buses satisfont aux directives DVS.

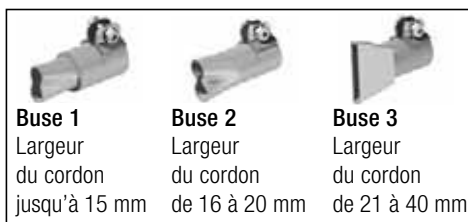

Gamme de patins de soudage

Leister Technologies AG propose des patins de soudage adaptés à toutes les formes courantes de cordon de soudure, en différentes dimensions:

WELDPLAST S2 / WELDPLAST S2-TPO avec conduit d'aération intégré

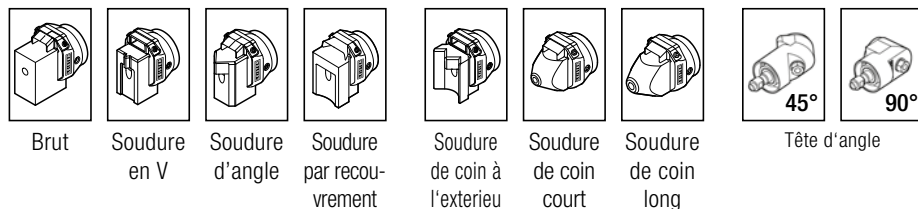

WELDPLAST S2 / WELDPLAST S2-PVC avec conduit d'aération externe

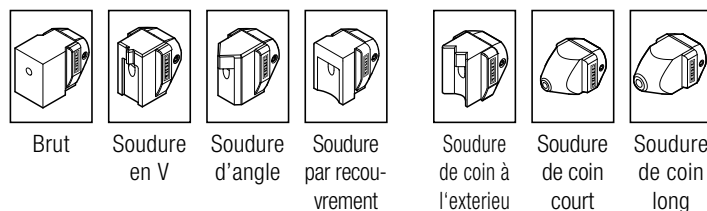

Accessoires

Seuls des **accessoires Leister** doivent être utilisés.

Reposoir pour outils



Dispositif transportable de déroulement du cordon de soudure

- Le dispositif est conçu pour bobines de cordons de soudure de Ø 300 mm.
- Afin de garantir un déroulement optimal du cordon de soudure, ce dernier doit être inséré dans les **œillets (41)** prévus.

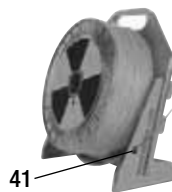

Entretien

- Contrôlez le câble d'**alimentation secteur (14)** et la fiche à la recherche de dommages électriques et mécaniques
- Éliminez les résidus de matière de soudure au niveau de la **buse d'extrusion (32)** à chaque remplacement du patin de soudage

Maintenance et réparation

- Les réparations doivent être réalisées exclusivement par les **SAV Leister** compétents. Ils garantissent un **service de réparation** approprié et fiable **sous 24 heures** avec des pièces détachées d'origine, conformément aux schémas de câblage et aux listes des pièces de rechange.
- Sur le modèle WELDPLAST S2, si le message de maintenance et le **code 1 s'affichent** après la mise sous tension de l'appareil, l'état des charbons doit être contrôlé par un **SAV Leister** compétent et les charbons du moteur d'entraînement doivent être remplacés, le cas échéant.
- Les messages peuvent être de nouveau masqués à l'aide de la **touche de sélection (28)** .
- Vous pouvez poursuivre temporairement le travail avec l'extrudeuse manuelle.
- Si les charbons ne sont pas remplacés dans l'intervalle de temps préconisé, l'entraînement fonctionne jusqu'à ce que la longueur minimum des charbons soit atteinte. Aucun message d'erreur ne s'affiche à l'écran, cependant l'entraînement ne fonctionne plus.



Garantie légale

- Les droits de garantie fabricant et de garantie légale accordés par le partenaire commercial ou vendeur direct s'appliquent à cet appareil à compter de la date d'achat. En cas de recours à la garantie (justificatif par la facture ou le bordereau de livraison), les défauts de fabrication ou d'usure seront supprimés par le partenaire commercial qui procédera à une fourniture en remplacement ou à une réparation. Les éléments chauffants sont exclus de la garantie.
- Toute autre prétention à la garantie fabricant ou à la garantie légale dans le cadre du droit en vigueur est exclue.
- Les dommages résultant d'une usure naturelle, d'une surcharge ou d'un traitement non conforme sont exclus de la garantie.
- Aucun droit à revendication n'est accordé pour les appareils qui auront été transformés ou modifiés par l'acheteur.



Istruzioni per l'uso (Traduzione del manuale di istruzioni originale)



Prima dell'attivazione leggere con attenzione le istruzioni per l'uso e conservarle per ulteriori consultazioni.

WELDPLAST S2 / S2-PVC / S2-TPO Leister Estrusore manuale

Applicazione

Saldatura ad estrusione dei materiali riportati di seguito:

WELDPLAST S2 PP / PE-HD / PE-LD
WELDPLAST S2-PVC PP / PE-HD / PE-LD / PVC-U
WELDPLAST S2-TPO PP / PE-HD / PE-LD / TPO
Altri materiali su richiesta

L'estrusore manuale soddisfa la normativa DVS 2207-4.

DVS: Deutscher Verband für Schweisstechnik (associazione tedesca saldatura)



Avvertenza



Aperto l'apparecchio è presente il **pericolo di morte** perché vengono esposti componenti e collegamenti sotto tensione. Estrarre la spina elettrica prima di procedere all'apertura dell'apparecchio. Non è consentito saldare i materiali elettroconduttori (ad es. PE-EL).



È presente il **pericolo di incendio e di esplosione** in caso di utilizzo non conforme dell'estrusore manuale (ad esempio, surriscaldamento del materiale), in particolare nelle vicinanze di materiali infiammabili e gas esplosivi.



Pericolo di ustione: non toccare i componenti metallici scoperti e i materiali fuoriusciti ad alte temperature. Lasciar raffreddare l'apparecchio. Non orientare il getto di aria calda e il materiale in uscita verso persone o animali.



Collegare l'apparecchio ad una **presa di corrente dotata di conduttore di terra**. Tutte le interruzioni del conduttore di terra all'interno o all'esterno dell'apparecchio sono pericolose.

Utilizzare esclusivamente cavi di prolunga dotati di conduttore di terra!



Attenzione



La **tensione nominale** specificata sull'apparecchio deve coincidere con la tensione di rete.

In caso di black-out è necessario disattivare l'interruttore principale e il motore (rimuovere l'arresto).



Se si utilizza l'apparecchio in cantiere, sono **tassativamente necessari** gli **interruttori per correnti di guasto** per garantire la tutela del personale.



È necessario mantenere l'apparecchio sotto **controllo** durante il funzionamento. Il calore può raggiungere materiali infiammabili che si trovano fuori dal campo visivo.

L'impiego dell'apparecchio è consentito esclusivamente a **personale specializzato** o sotto il monitoraggio di quest'ultimo. È tassativamente vietato l'impiego da parte dei bambini.



Proteggere l'apparecchio da umidità e da ambienti bagnati.

Conformità

Leister Technologies AG, Galileo-Strasse 10, CH-6056 Kaegiswil/Svizzera dichiara che il presente prodotto, nella versione introdotta sul mercato, soddisfa i requisiti delle direttive CE riportate di seguito.

Direttive:	2006/42, 2004/108 (fino al 19.04.2016), 2014/30 (dal 20.04.2016) 2006/95 (fino al 19.04.2016), 2014/35 (dal 20.04.2016) 2011/65
Norme armonizzate:	EN 12100, EN 55014-1, EN 55014-2, EN 61000-6-2, EN 61000-3-2, EN 61000-3-3, EN 62233, EN 60335-1, EN 60335-2-45, EN 50581

Kaegiswil, 04.01.2016

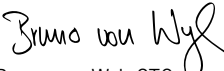
Bruno von Wyl, CTO

Andreas Kathriner, GM

Smaltimento



Gli apparecchi elettrici, gli accessori e gli imballaggi devono essere riciclati nel rispetto dell'ambiente.
Solo per i Paesi UE: Non smaltire gli apparecchi elettrici insieme ai rifiuti domestici!

Specifiche tecniche

Tensione	V~	230	200
Potenza	W	3000	2400
Frequenza	Hz	50/60	
Portata d'aria (20 °C)	l/min	300	
Temperatura dell'aria max.	°C	350	
Temperatura di plastificazione max.	°C	260	
Espulsione (Ø 3 mm)	kg/h	PE 0.6–1.3 PP 0.5–1.2 *PVC-U 0.9–1.7 (valori medi a 50 Hz)	
Espulsione (Ø 4 mm)	kg/h	PE 1.0–2.3 PP 0.9–2.0 *PVC-U 1.5–2.7 (valori medi a 50 Hz)	
Filo per saldatura	mm	Ø 3 / Ø 4	
Dimensioni L × P × H	mm	450 × 98 × 260 (senza pattino di saldatura)	
Peso	kg	5.8 (senza linea di allacciamento alla rete)	
Marchio di conformità		CE	CE
Marchio di sicurezza		Ⓢ	
Classe di protezione I		Ⓛ	Ⓛ

* WELDPLAST S2-PVC

Con riserva di modifiche tecniche

Descrizione dell'apparecchio

Condotta aria esterna in dotazione

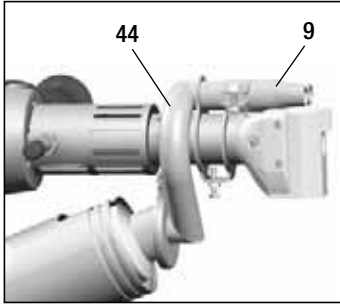

Condotta aria integrata in dotazione

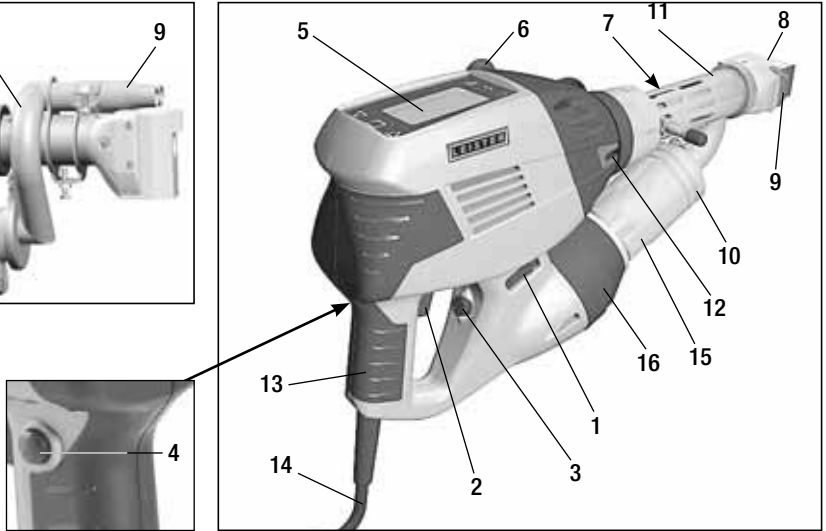

- 1 Interruttore principale
- 2 Interruttore ON/OFF motore
- 3 Potenziometro
- 4 Arresto motore
- 5 Display
- 6 Impugnatura
- 7 Riscaldamento del rivestimento
- 8 Pattino di saldatura
- 9 Ugello di preriscaldamento

- 10 Morsetto per tubi
- 11 Tubo di protezione
- 12 Ingresso del filo per saldatura
- 13 Impugnatura dell'apparecchio
- 14 Linea di allacciamento alla rete
- 15 Tubo di protezione con resistenza
- 16 Soffiatrice di aria calda (senza spazzole)
- 44 Condotta esterna aria calda

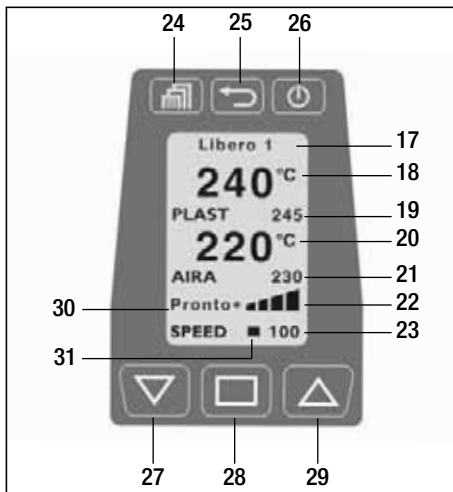

Unità di controllo

- 17 Programma di saldatura
- 18 Valore reale Plast
- 19 Valore nominale Plast
- 20 Valore reale Air
- 21 Valore nominale Air
- 22 Barre indicatrici motore
- 23 Indicazione espulsione
- 24 Pulsante MENU
- 25 Pulsante BACK
- 26 Pulsante STAND-BY / ENTER
- 27 Pulsante DOWN
- 28 Pulsante SELECT
- 29 Pulsante UP
- 30 Indicazione di stato motore
- 31 Corsore

Ambiente lavorativo / Sicurezza



Non è consentito utilizzare l'estrusore manuale in ambienti a rischio d'esplosione o infiammabili. Prestare attenzione alla stabilità durante le operazioni. La linea di allacciamento alla rete e il filo per saldatura devono potersi muovere senza problemi senza ostacolare l'utente e o terze persone durante le operazioni.



Disporre l'estrusore manuale su una base ignifuga. Le parti in metallo e il getto di aria calda devono presentare una distanza adeguata dal supporto e dalle pareti.

Impostazione dell'impugnatura

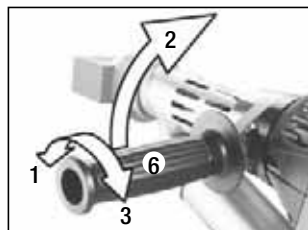

1. Ruotando l'**impugnatura (6)** in senso antiorario allentare il bloccaggio.
2. Portare l'**impugnatura (6)** nella posizione desiderata.
3. Ruotando l'**impugnatura (6)** in senso orario serrarla a fondo nuovamente.

Postazione di lavoro



Leister offre una supporto per apparecchiature universale per attivare e riporre l'**estrusore manuale**.

In caso di interruzione delle operazioni di saldatura è necessario disattivare il motore con l'**interruttore ON/OFF motore (2)**.

Disporre l'estrusore manuale su una base stabile ed ignifuga con l'impugnatura regolata in modo corretto e serrata a fondo come mostrato in figura.

Cavo di prolunga

Prestare attenzione alla sezione minima quando si utilizzano i cavi di prolunga:

Il cavo di prolunga deve essere omologato per il luogo d'impiego (ad es. per esterni) e dotato delle marcature adeguate.

Quando si utilizza un gruppo di alimentazione elettrica, la sua potenza nominale deve essere pari al doppio della potenza nominale dell'estrusore manuale.

Lunghezza [m]	Sezione minima trasversale (a 230V~) [mm ²]
Fino a 19	2,5
20 – 50	4,0

Preparazione alla saldatura

Il monitoraggio della temperatura impedisce il raggiungimento delle condizioni di raffreddamento dell'estrusore manuale.

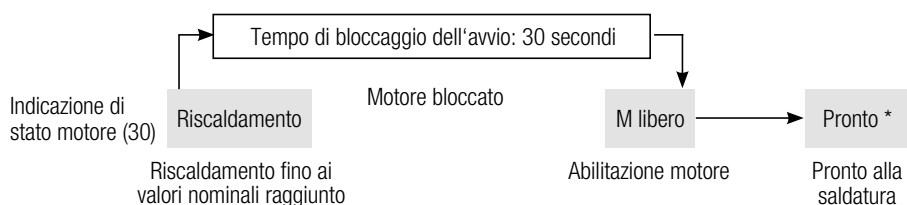

L'apparecchio si riscalda subito dopo l'attivazione dell'**interruttore principale (1)** raggiungendo la temperatura nominale impostata per ultima. Se sono state raggiunte le temperature nominali, un contatore nell'indicazione di stato avvia un conto alla rovescia partendo da 30 secondi. Al termine del processo di avvio l'apparecchio è pronto alla saldatura (stato pronto*). L'estrusore manuale raggiunge la sua temperatura d'esercizio dopo 4 minuti circa. In caso di breve black-out a breve termine, non ha luogo un nuovo processo di avvio.

Software e guida menu

L'estrusore manuale Weldplast S2 è dotato di un pratico software di controllo che semplifica le operazioni dell'utente. I pulsanti si attivano semplicemente sfiorandoli.

	Funzioni finestra operativa	Funzioni selezione del menu
	Selezione menu	Selezione MENU / Tornare alla finestra operativa
	impostazione del contrasto	Tornare indietro alla finestra operativa (la modifica non viene memorizzata).
	Riscaldamento ON/OFF	Selezionare e tornare indietro alla finestra operativa
	Modificare la posizione del cursore	Selezionare
	Valore selezionato [+]	Cursore in alto / Valore selezionato [+]
	Valore selezionato [-]	Cursore in basso / Valore selezionato [-]

Finestra di avvio

Sul display vengono visualizzati il nome dell'apparecchio e la versione del software per 3 secondi dopo l'attivazione dell'estrusore manuale dall'**interruttore principale (1)**.



Finestra operativa

La finestra operativa mostra i parametri correnti configurati.

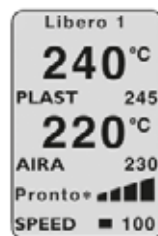

Impostazione dei parametri nella finestra operativa

Il **cursore (31)** indica quale parametro è possibile impostare. Dopo l'attivazione il cursore si trova in posizione „SPEED“. Con il **pulsante SELECT (28)** è possibile selezionare „AIR“ o „PLAST“ e con il **pulsante UP (29)** o il **pulsante DOWN (27)** modificarne i rispettivi valori.

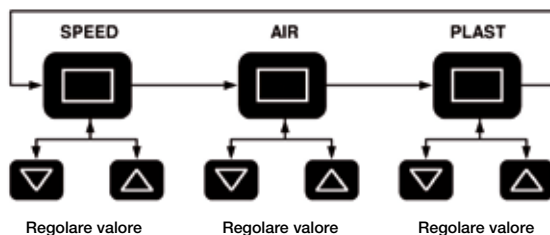

Preparazione alla saldatura

Impostazione della quantità espulsa

A causa della forma di saldatura è possibile adattare reciprocamente la quantità espulsa e il tempo di preriscaldamento.

- Preimpostazione sul display
 - Premendo il **pulsante SELECT (28)** impostare il cursore su „SPEED“.
 - Definire il valore di espulsione massimo (da 30 a 100 %) con il **pulsante UP (29)** o il **pulsante DOWN (27)** (visualizzazione con la **barra indicatrice motore (22)**).
- Regolazione di precisione durante il processo di saldatura
 - È possibile ridurre la quantità espulsa dal valore massimo impostato (ad es. 85%) fino al livello minimo ruotando il **potenziometro (3)**

La quantità espulsa dipende dallo spessore del filo per saldatura impiegato. Se l'espulsione con l'indicazione „30“ e la regolazione del potenziometro „minimo“ risultano troppo elevate, è necessario passare allo spessore del filo per saldatura più sottile.

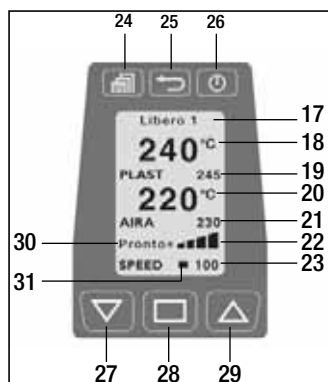

Impostazione delle temperature PLAST e AIR

- Premendo il **pulsante SELECT (28)** impostare il cursore su „PLAST“ o „AIR“.
- Impostare il valore della temperatura con il **pulsante UP (29)** o il **pulsante DOWN (27)**.

Esempio

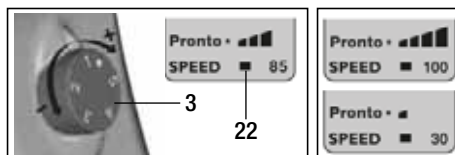

Monitoraggio dei parametri di saldatura

I valori nominali e reali delle temperature AIR e PLAST sono sottoposti a un monitoraggio costante. Se il valore reale si discosta dal rispettivo valore nominale (il valore è al di fuori dall'intervallo di tolleranza), questa condizione viene segnalata dal cambiamento di stato sull'**indicazione di stato (30)**. In caso di necessità il motore di azionamento viene bloccato provvisoriamente fino a quando i parametri di saldatura non si trovano nuovamente all'interno dell'intervallo di tolleranza preimpostato. Le eventuali indicazioni dello stato e gli intervalli della tolleranza sono riportati nella seguente figura o nella tabella.

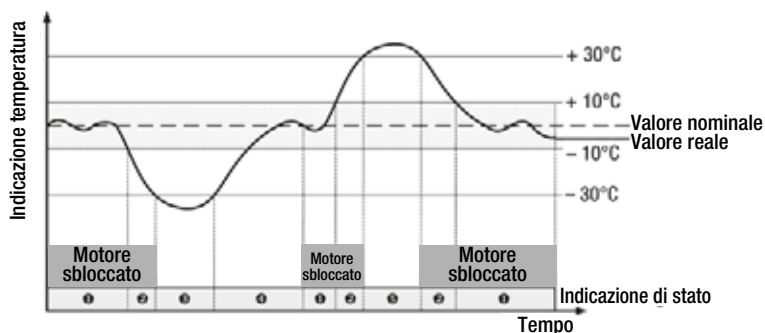

Num.	Indicazione dello stato	Proprietà dello stato
1	Pronto*	Pronto alla saldatura
2	M libero	Differenza dei parametri di saldatura (plastica) > 10°C
3	Riscaldamento	Differenza dei parametri di saldatura (plastica) > - 30°C: motore di azionamento bloccato.
4	30s	Tempo di bloccaggio dell'avvio di 30 sec., motore di azionamento bloccato
5	troppo caldo	Differenza dei parametri di saldatura > + 30°C: motore di azionamento bloccato

Avvio del processo di saldatura

- Montare il **pattino di saldatura (8)** adeguato a seconda delle esigenze
- Impostare il **potenziometro (3)** su max.
- Se si raggiunge la temperatura d'esercizio (stato pronto*), è possibile iniziare il processo di saldatura
- Selezionare l'**interruttore ON/OFF motore (2)**.
- Inserire il **filo per saldatura** con un diametro di 3 o 4 mm nell'**apposito ingresso (12)**.
- Il filo per saldatura viene ritratto in modo automatico dall'**ingresso del filo per saldatura (12)**. L'alimentazione del filo deve avvenire senza eventuali resistenze.



ATTENZIONE!

Azionare sempre l'apparecchio con il filo per saldatura, ma non inserire mai il filo per saldatura in entrambi gli ingressi allo stesso tempo.

- Interrompere il trasporto massa con l'**interruttore ON/OFF motore (2)**.
- Orientare l'**ugello di preriscaldamento (9)** sulla zona di saldatura.
- Preriscaldare la zona di saldatura con movimenti oscillatori.
- Applicare l'apparecchio alla zona di saldatura predisposta e selezionare nuovamente l'**interruttore ON/OFF motore (2)**.
- Effettuare una saldatura di prova in base alle istruzioni di saldatura del produttore del materiale e alle normative o alle direttive nazionali.
- Verificare la saldatura di prova.
- Adattare la regolazione della temperatura e la quantità espulsa a seconda delle esigenze.
- In caso di un processo di saldatura prolungato l'**interruttore ON/OFF (2)** è in grado di arrestare il motore con l'**arresto motore (4)** in fase di funzionamento continuo.

WELDPLAST S2 - PVC

- È consentita la lavorazione di PVC-U solo nel menu PVC-U. ATTENZIONE: Utilizzare solo PVC-U, non PVC-C
- Per prevenire la corrosione si consiglia di riempire l'apparecchio con HD-PE in caso di periodo di mancato impiego prolungato (oltre i 2 giorni).

Parametri di saldatura

MENU



Selezionare il programma



Selezione



Digitazione



Programma: L'indicazione dei materiali può subire eventuali variazioni a seconda del versione delle apparecchiature e del software.

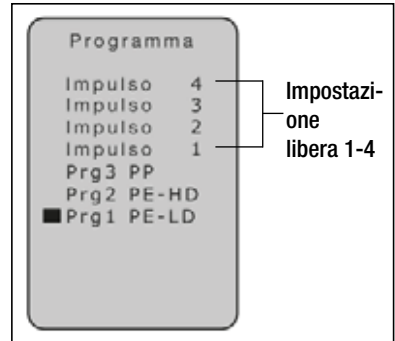

I **programmi 1 – 3** sono dotati di parametri adeguatamente preconfigurati che è possibile modificare durante il processo di saldatura.

Le regolazioni non vengono memorizzate.

Le impostazioni libere 1 – 4 sono di fabbrica e possono essere programmate liberamente. I parametri rimangono memorizzati anche dopo la disattivazione dell'apparecchio.

Programma di saldatura	Valore nominale PLAST [°C]	Valore nominale AIR [°C]
Digitazione libera 1 – 4	230	260
Prg1 PE-LD	220	260
Prg2 PE-HD	230	260
Prg3 PP	240	260
Prg0 PVC-U	200	300

Il **programma di saldatura (17)** attualmente impostato è visibile dalla finestra operativa.

L'indicazione dei materiali può subire eventuali variazioni a seconda del versione delle apparecchiature e del software.

Impostazione della quantità espulsa

- Premendo il **pulsante SELECT (28)** impostare il cursore su „SPEED“.
- Impostare il valore di espulsione (da 30 al 100%) con il **pulsante UP (29)** o il **pulsante DOWN (27)**.

Impostazione della temperatura PLAST e AIR

- Premendo il **pulsante SELECT (28)** impostare il cursore su „PLAST“ o „AIR“.
- Impostare il valore della temperatura con il **pulsante UP (29)** o il **pulsante DOWN (27)**.

Disattivazione dell'apparecchio

- Rimuovere l'**arresto motore (4)** e sbloccare l'**interruttore ON/OFF motore (2)**.
Rimuovere il materiale di saldatura presente nel pattino di saldatura per evitare eventuali danni del pattino di saldatura durante la movimentazione successiva.
- Disattivare i sistemi di riscaldamento con il **pulsante STAND-BY / ENTER (26)**.
- Lasciar raffreddare l'apparecchio per 5 minuti circa.
- Disattivare l'**interruttore principale (1)**.

Altre impostazioni



Impostazione del contrasto

In presenza di condizioni d'illuminazione particolarmente sfavorevoli e di sbalzi termici dell'ambiente è possibile impostare il contrasto con il **pulsante BACK (25)**.

Riscaldamento ON/OFF

In caso di un'interruzione prolungata (stand-by) è possibile disattivare il sistema di riscaldamento per PLAST e AIR con il **pulsante STAND-BY / ENTER (26)**.

Attivazione del blocco pulsanti

1. MENU 
2. Blocco pulsanti 
3. Attivare 

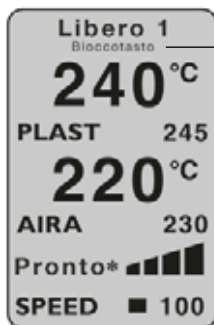

Se il blocco pulsanti è attivato, sul display viene visualizzata l'icona corrispondente.



Blocco pulsanti attivato

È possibile effettuare nuovamente il reset del blocco come riportato di seguito:

Disattivazione del blocco pulsanti

1. BACK [indietro] 
2. Effettuare il reset. 
3. Selezionare 

Subito dopo il reset la conferma deve avvenire con il pulsante SELECT.

Guida menu

MENU

- MENU 
- Selezione  
- Selezionare 

Funzioni

- Selezione  
- Selezionare e indietro 
- Tornare alla finestra operativa di selezione 

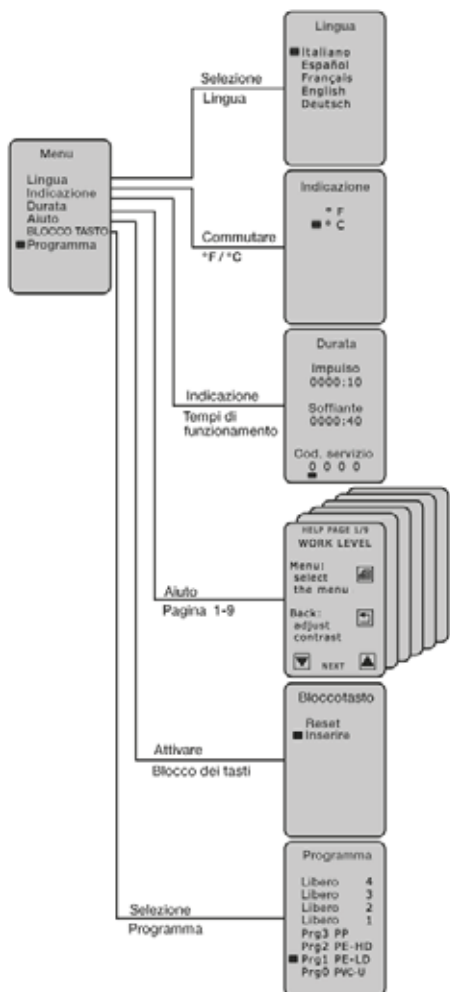

Messaggi di guasto

Se si verifica un guasto, questo viene visualizzato nell'**indicazione di stato (30)** (ad es. **Err04** motore surriscaldato).

Indicazione **ErrXX**

Quando si verifica un guasto i sistemi di riscaldamento per AIR e PLAST, oltre al motore di azionamento, vengono immediatamente disattivati.

In caso contrario, è obbligatorio scollegare immediatamente l'apparecchio dalla rete.

Altra procedura con l'indicazione di stato motore (30) **ErrXX**

- Annotare il codice d'errore.
- Rimuovere l'**arresto motore (4)** e sbloccare l'**interruttore ON/OFF motore (2)**.
- Disattivare l'**interruttore principale (1)**.
- Mettere nuovamente in funzione l'apparecchio tenendolo sotto controllo e prestare attenzione al fatto che l'estrusore manuale non venga surriscaldato dall'esterno.
- Espellere, se possibile, il materiale plastico rimasto nella coclea.
- Nel caso in cui il guasto si verifichi nuovamente, è necessario inviare l'apparecchi al centro del servizio di assistenza tecnica specificando il codice errore per effettuare i controlli necessari.

I guasti riportati di seguito vengono riconosciuti dall'apparecchio.

Indicazione	tipo di guasto
Err01	Surriscaldamento dell'aria o sonda termica difettosa.
Err02	Surriscaldamento del materiale plastico o sonda termica difettosa .
Err04	Surriscaldamento nell'avvolgimento motore: il motore è surriscaldato.
Err08	Surriscaldamento della resistenza AIR o avaria del motore della ventola
Err10	Surriscaldamento dell'impianto elettronico
Err40	Cortocircuito della sonda termica PLAST

Se si verificano diversi guasti allo stesso tempo, ad esempio **Err02** e **Err04**, viene visualizzato **Err06**.

Le altre combinazioni vengono visualizzate con le lettere A, B, C, D, E ed F, come ad esempio per **Err08** e **Err02** l'indicazione è **Err0A**.

Protezione antisurriscaldamento motore

Se il motore viene surriscaldato da agente esterno o in presenza di una temperatura PLAST troppo ridotta, la protezione termica interna disattiva il motore (vedere **Err04**).

Protezione dell'accensione motore

Il motore di azionamento è bloccato dopo gli eventuali guasti, come ad esempio il surriscaldamento **Err04**, per impedire avviamento autonomo. Sul **display (5)** viene visualizzato il messaggio „Disattivare il motore“ mentre il motore di azionamento rimane fermo nello stato di blocco. Una volta risolto il malfunzionamento e disattivato il motore (rimuovere l'**arresto motore (4)** e sbloccare l'**interruttore ON/OFF motore (2)**), dal **display (5)** scompare l'indicazione „Disattivare il motore“. È possibile eseguire lavorazioni secondarie.

Cambio di accessori



Pericolo di ustione!



Eeguire le operazioni solo con guanti termoresistenti.

Sostituzione del pattino di saldatura

È necessario eseguire la sostituzione del pattino di saldatura con l'apparecchio caldo per il funzionamento.

Smontaggio

- Disattivare l'apparecchio caldo per il funzionamento e scollegarlo dalla rete elettrica.
- Rimuovere il **pattino di saldatura (8)** con il **relativo supporto (34)** allentando la **vite d'arresto (35)** dall'**ugello dell'estrusore (32)**.
- Ad ogni sostituzione dei panni di saldatura, pulire l'**ugello dell'estrusore (32)** dai residui della saldatura ed accertarsi che sia serrato a fondo.
- Rimuovere il **pattino di saldatura (8)** allentando le **viti di fissaggio (33)** dal supporto per il **pattino di saldatura (34)**.

Montaggio

- Montare uno dei **pattini di saldatura (8)** adattati alla saldatura sull'**apposito supporto (34)** con le **viti di fissaggio (33)**.
- È necessario serrare correttamente il **pattino di saldatura (8)** e l'**apposito supporto (34)** con le **viti d'arresto (35)**.

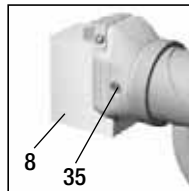
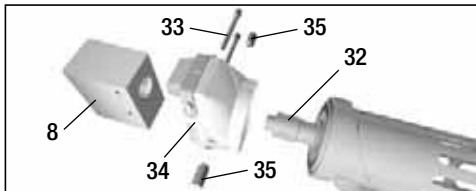

- 8 Pattino di saldatura
- 32 Ugello dell'estrusore
- 33 Vite di fissaggio
- 34 Supporto del pattino di saldatura
- 35 Vite d'arresto

Direzione della saldatura

Allentando le **viti d'arresto (35)** è possibile far ruotare in modo continuo il **pattino di saldatura (8)** fino a raggiungere la direzione di saldatura desiderata. Dopo questa operazione è necessario serrare nuovamente a fondo la **vite d'arresto (35)**.

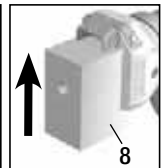
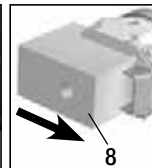
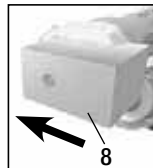

Sostituzione della condotta aria calda

Per smontare la **condotta aria calda (44)**, si rimuove innanzitutto il **pattino di saldatura (8)**. È possibile estrarre tutta l'unità dopo aver allentato la **vite di fissaggio (45)** fissata con un controdado sul **morsetto per tubi (10)** e la **vite d'arresto (47)** sul raccordo del condotto aria calda.

Eeguire il montaggio nella sequenza inversa.

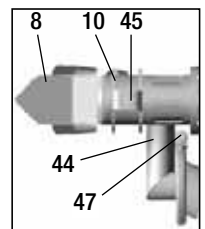

Sostituzione dell'ugello di preriscaldamento

Smontaggio: In presenza dell'**ugello di preriscaldamento (9)**, allentare la **vite d'arresto (43)** e estrarre l'**ugello di preriscaldamento (9)** dalla **condotta aria calda (44)**.

Montaggio: Far scorrere l'**ugello di preriscaldamento (9)** sulla **condotta aria calda (44)**.
Verificare che il pattino ugelli sia disposto parallelamente.
Serrare la **vite d'arresto (43)**.

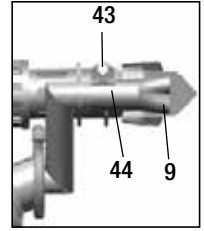

Ugelli di preriscaldamento per gli apparecchi con condotta aria esterna

Sono disponibili tre diversi ugelli di **preriscaldamento (9)** che corrispondono alle larghezze di saldatura. Le sezioni trasversali degli ugelli soddisfano le direttive DVS.

		
Ugello 1	Ugello 2	Ugello 3
Larghezza della saldatura fino a 15 mm	Larghezza della saldatura da 16 a 20 mm	Larghezza della saldatura da 21 a 40 mm

Gamma del pattino di saldatura

Per tutte le comuni forme di saldatura Leister Technologies AG offre pattini di saldatura adeguati in diversi formati.

WELDPLAST S2 / WELDPLAST S2-TPO condotta aria integrata in dotazione

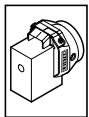

Pezzo grezzo

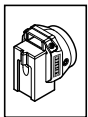

Saldatura a V



Saldatura a gola

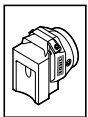

Saldatura a sovrapposizione

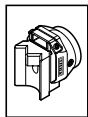

Saldatura in angolo esterna



Saldatura in angolo corta



Saldatura in angolo lunga

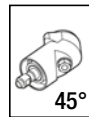

45°



90°

Testa angolare

WELDPLAST S2 / WELDPLAST S2-PVC condotta aria esterna in dotazione

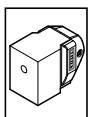

Pezzo grezzo

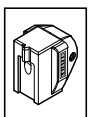

Saldatura a V

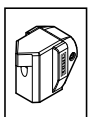

Saldatura a gola

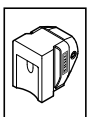

Saldatura a sovrapposizione

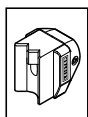

Saldatura in angolo esterna



Saldatura in angolo corta



Saldatura in angolo lunga

Accessori

È consentito utilizzare solo gli **accessori Leister**.

Supporto per apparecchiature



Svolgitore per filo di saldatura portatile

- Il dispositivo è progettato per rulli del filo per saldatura con un diametro di 300 mm.
- È necessario far passare il filo per saldatura per l'**apposito occhio (41)** per garantire uno svolgimento del filo ottimale.

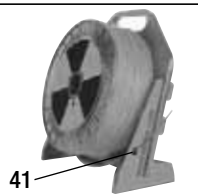

Manutenzione

- Controllare la presenza di guasti elettrici e meccanici nella linea di **allacciamento alla rete (14)** e nella spina elettrica.
- Eliminare i residui della saldatura dall'**ugello dell'estrusore (32)** ad ogni sostituzione del pattino di saldatura.

Servizio di assistenza e riparazione

- Le riparazioni devono essere eseguite esclusivamente dai **centri di assistenza tecnica Leister** autorizzati. I centri di assistenza garantiscono un **servizio di riparazione** professionale ed affidabile **entro 24 ore** con pezzi di ricambio originali conformi agli schemi elettrici e agli specifici elenchi.
- Se, dopo l'attivazione dell'apparecchio, per WELDPLAST S2 viene visualizzata l'indicazione di servizio con **codice 1**, si consiglia di far controllare il livello del carbone da parte di un **centro di assistenza tecnica autorizzato Leister** ed eventualmente procedere alla sostituzione delle spazzole di carbonio del motore.
- È possibile eliminare nuovamente la visualizzazione con il **pulsante SELECT (28)** .
- È possibile effettuare altre lavorazioni a breve termine con l'estrusore manuale.
- Se non si sostituiscono le spazzole di carbonio entro le scadenze utili, il motore avanza fino a quando non si raggiunge l'apposito arresto meccanico. Sul display non viene visualizzato nessun messaggio d'errore, ma il motore non funziona più.



Garanzia legale

- A questo prodotto si applicano i diritti previsti per la garanzia concessi dal partner di distribuzione/rivenditore diretto, a partire dalla data di acquisto. In caso di ricorso alla garanzia (fanno fede la fattura o la bolla di consegna), sono previste la fornitura sostitutiva o la riparazione di difetti di fabbricazione o di lavorazione a cura del partner di distribuzione. La garanzia non si applica agli elementi riscaldanti.
- È esclusa qualsiasi ulteriore garanzia non espressamente prevista dalle vigenti norme di diritto cogente.
- Sono esclusi dalla garanzia i danni riconducibili alla naturale usura, al sovraccarico o alla scorretta manipolazione.
- Il ricorso alla garanzia decade per gli apparecchi sottoposti a modifiche o alterazioni da parte dell'acquirente.



Lea las instrucciones de funcionamiento atentamente antes de la puesta en funcionamiento y consérvelas para el futuro.

Leister WELDPLAST S2 / S2-PVC / S2-TPO Extrusora manual

Aplicación

Soldadura por extrusión de los siguientes materiales:

WELDPLAST S2 PP / PE-HD / PE-LD

WELDPLAST S2-PVC PP / PE-HD / PE-LD / PVC-U

WELDPLAST S2-TPO PP / PE-HD / PE-LD / TPO

Otros materiales a petición

La extrusora manual cumplen la norma DVS 2207-4.

DVS: Asociación alemana de soldadura



Advertencia



Existe **peligro de muerte** al abrir el equipo, ya que se dejan al descubierto componentes y conexiones sometidos a tensión. Antes de abrir el equipo, desconecte el enchufe. No se puede soldar material con conductividad eléctrica (por ejemplo, PE-EL).



Peligro de fuego y explosiones en caso de un uso incorrecto de la extrusora manual (por ejemplo, sobrecalentamiento del material), especialmente cerca de materiales inflamables y gases explosivos.



¡Peligro de quemaduras! No toque las piezas metálicas descubiertas ni la masa resultante si están calientes. Espere a que el equipo se enfríe. No dirija el chorro de aire caliente ni la masa resultante hacia personas o animales.



Conecte el equipo a un **enchufe con conductor de protección**. Las interrupciones en el conductor de protección, ya se produzcan dentro o fuera del equipo, son peligrosas.

¡Utilice únicamente un cable alargador con conductor de protección!



Precaución



La **tensión nominal** indicada en el dispositivo debe coincidir con la tensión de red. En caso de fallo de alimentación se debe desconectar el interruptor principal y el accionamiento (soltar el bloqueo).



Es **imprescindible un interruptor FI** para el empleo del equipo, a modo de protección personal.



El equipo **debe permanecer vigilado** mientras esté funcionando. El calor puede llegar a materiales inflamables que se encuentren fuera del ámbito visual.

El aparato sólo podrá ser utilizado por **personal especializado debidamente formado** o bajo su vigilancia. Se prohíbe terminantemente su uso por parte de niños.



Proteger el aparato de la humedad y el agua.

Conformidad

Leister Technologies AG, Galileo-Strasse 10, CH-6056 Kaegiswil/Suiza declara que este producto, en la versión que hemos puesto en circulación, cumple los requisitos de las siguientes directivas de la CE.

Directivas:	2006/42, 2004/108 (hasta el 19.04.2016), 2014/30 (a partir del 20.04.2016) 2006/95 (hasta el 19.04.2016), 2014/35 (a partir del 20.04.2016) 2011/65
Normas armonizadas:	EN 12100, EN 55014-1, EN 55014-2, EN 61000-6-2, EN 61000-3-2, EN 61000-3-3, EN 62233, EN 60335-1, EN 60335-2-45, EN 50581

Kaegiswil, 04.01.2016

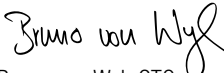
Bruno von Wyl, CTO

Andreas Kathriner, GM

Eliminación



Las herramientas eléctricas, los accesorios y los embalajes deben reciclarse y reutilizarse de forma adecuada para proteger el medio ambiente. **Solo para países de la Unión Europea:** No desechar jamás herramientas eléctricas en la basura doméstica.

Datos técnicos

Tensión	V~	230	200
Potencia	W	3000	2400
Frecuencia	Hz	50/60	
Cantidad de aire (20 °C)	l/min	300	
Temperatura del aire	°C	máx. 350	
Temperatura de plastificado	°C	máx. 260	
Rendimiento (Ø 3 mm)	kg/h	PE 0,6–1,3 PP 0,5–1,2 *PVC-U 0,9–1,7 (valores medios a 50 Hz)	
Rendimiento (Ø 4 mm)	kg/h	PE 1,0–2,3 PP 0,9–2,0 *PVC-U 1,5–2,7 (valores medios a 50 Hz)	
Alambre para soldar	mm	Ø 3 / Ø 4	
Masa L × An × Al	mm	450 × 98 × 260 (sin zapata de soldadura)	
Peso	kg	5,8 (sin cable de conexión de red)	
Marca de conformidad	CE	CE	
Marca de seguridad	Ⓢ		
Clase de protección I	Ⓢ	Ⓢ	

* WELDPLAST S2-PVC

Sujeto a modificaciones técnicas

Descripción del equipo

Con conducto de aire externo

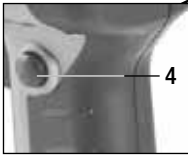
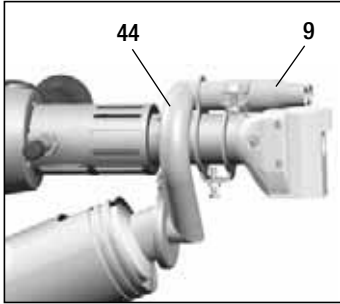

Con conducto de aire integrado

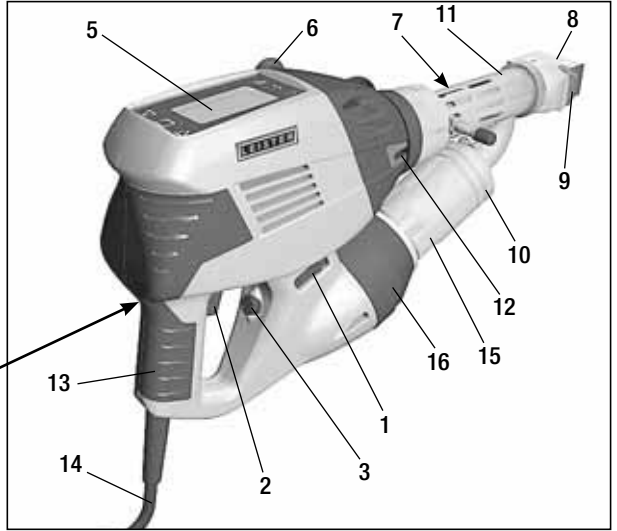

- 1 Interruptor principal
- 2 Interruptor de conexión y desconexión del accionamiento
- 3 Potenciómetro
- 4 Bloqueo de accionamiento
- 5 Pantalla
- 6 Mango
- 7 Camisa calefactora
- 8 Zapata de soldadura

- 9 Boquilla de precalentamiento
- 10 abrazadera de tubo
- 11 Tubo de protección
- 12 Entrada del alambre para soldar
- 13 Empuñadura del aparato
- 14 Cable de conexión de red
- 15 Elemento calefactor con tubo de protección
- 16 Soplante de aire caliente (sin escobillas)
- 44 Conducto de aire caliente externo

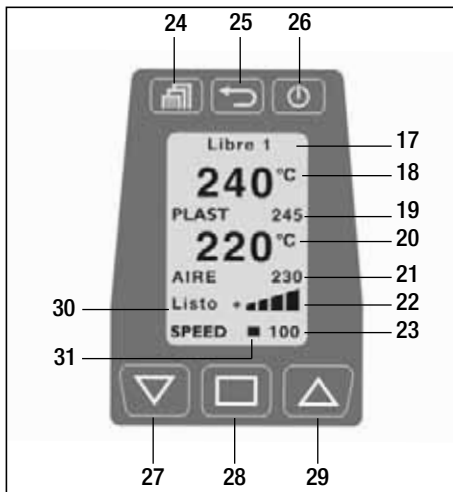

Unidad de mando

- 17 Programa de soldadura
- 18 Valor real Plast
- 19 Valor teórico Plast
- 20 Valor real Air
- 21 Valor teórico Air
- 22 Barra indicadora de accionamiento
- 23 Indicador de rendimiento
- 24 Tecla de menú
- 25 Tecla Back
- 26 Tecla Standby/Enter
- 27 Tecla Down
- 28 Tecla Select
- 29 Tecla Up
- 30 Indicador de estado de accionamiento
- 31 Cursor

Entorno de trabajo / Seguridad



La extrusora manual no puede emplearse en entornos con peligro de explosiones o incendio. Garantice siempre un trabajo seguro. El cable de conexión de red y el alambre para soldar deben poder moverse con libertad y no dificultar el trabajo del usuario ni de un tercero.



La extrusora manual debe colocarse sobre una superficie incombustible. Debe haber una distancia suficiente entre las piezas de metal calientes, el chorro de aire caliente, la base y las paredes.

Ajuste del mango

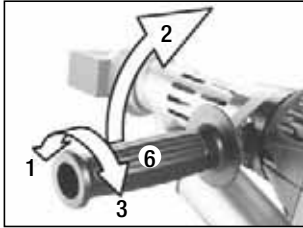

1. Girando el **mango (6)** en sentido contrario a las agujas del reloj, aflojar el bloqueo
2. Colocar el **mango (6)** en la posición de trabajo deseada
3. Girando el **mango (6)** en sentido de las agujas del reloj, volver a apretar el bloqueo

Lugar de trabajo



Para la puesta en marcha y el soporte de la extrusora manual, Leister ofrece un **soporte universal de dispositivos**.



Cuando se interrumpan los trabajos de mantenimiento, se debe desconectar el accionamiento con el **interruptor de conexión y desconexión del accionamiento (2)**. Colocar la extrusora manual con el mango ajustado y bien sujeto sobre una superficie estable e incombustible, como se indica en la imagen.

Cable alargador

Si se utilizan cables alargadores, se debe tener en cuenta la sección transversal mínima:

El cable alargador debe estar autorizado para su uso en el lugar de utilización (p. ej., en exteriores) y estar identificado como corresponda.

Si se utiliza un grupo para el suministro de energía, su potencia nominal deberá ser el doble de la de la extrusora manual.

Longitud [m]	Sección transversal mínima (a 230V~) [mm ²]
Hasta 19	2,5
20 – 50	4,0

Preparación de la soldadura

El control de temperatura impide arrancar la extrusora manual en frío.

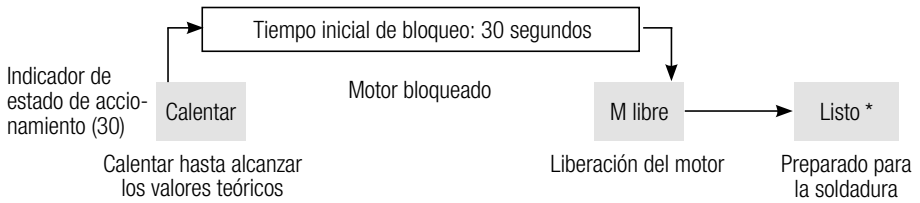

El dispositivo se calienta directamente tras encender el **interruptor principal (1)** hasta alcanzar la temperatura nominal ajustada la última vez. Una vez alcanzadas las temperaturas nominales, el contador en el indicador de estado realiza una cuenta atrás partiendo de 30 segundos. Tras este proceso de arranque, el dispositivo estará listo para la soldadura (estado Listo*). La extrusora manual alcanzará la temperatura de funcionamiento a los 4 minutos aprox. En caso de una interrupción breve de la alimentación, no será necesario repetir el proceso de arranque.

Software y menús

La extrusora manual Weldplast S2 está equipada con un software de manejo cómodo que facilita el trabajo del usuario. Las teclas se activan pulsándolas ligeramente.

	Funciones en la ventana de trabajo	Funciones en el menú de selección
	Menú de selección	Menú de selección / Volver a la ventana de trabajo
	Ajustar contraste	Volver a la ventana de trabajo (no se guardará el cambio)
	Calefacción ON/OFF	Seleccionar y volver a la ventana de trabajo
	Modificar posición del cursor	Seleccionar
	Valor seleccionado [+]	Cursor hacia arriba / Valor seleccionado [+]
	Valor seleccionado [-]	Cursor hacia abajo / Valor seleccionado [-]

Ventana de inicio

En la pantalla se mostrarán durante 3 segundos, tras encender la extrusora manual con el **interruptor principal (1)**, el nombre del dispositivo y la versión de software actual.



Ventana de trabajo

La ventana de trabajo muestra los parámetros ajustados en este momento.



Ajuste de parámetros en la ventana de trabajo

El **cursor (31)** muestra el parámetro que se puede ajustar. Tras la conexión, el cursor se encuentra en la posición «SPEED». Con la **tecla Select (28)** se puede seleccionar «AIR» o «PLAST» y con la **tecla Up (29)** o **Down (27)** es posible cambiar sus valores.

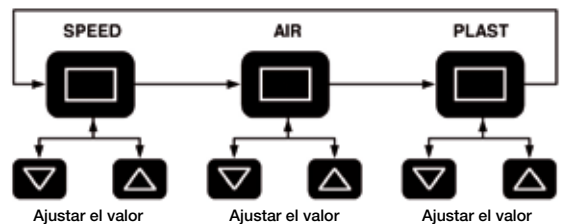

Preparación de la soldadura

Ajuste de la cantidad de extrusión

En función de la forma de la costura se pueden ajustar la cantidad de extrusión y el tiempo de precalentamiento.

- Preajuste en la pantalla
 - Con la **tecla Select (28)** colocar el cursor en la posición «SPEED».
 - Definir el valor máximo de rendimiento (de 30 a 100%) con la **tecla Up (29)** o **Down (27)** (se representa con la **barra indicadora de accionamiento (22)**)
- Ajuste de precisión durante el proceso de soldadura
 - Desde el valor de rendimiento máximo ajustado (por ejemplo, 85%) se puede reducir al mínimo la cantidad de extrusión girando el **potenciómetro (3)**

La cantidad de extrusión dependerá del grosor del alambre para soldar empleada. Si con el indicador de rendimiento «30» y ajuste de potenciómetro «Minimum» el rendimiento es demasiado elevado, se deberá cambiar el alambre para soldar al siguiente grosor más pequeño.

Ajuste de las temperaturas PLAST y AIR

- Con la **tecla Select (28)** colocar el cursor en la posición «PLAST» o «AIR»
- El valor de temperatura se ajustará con la **tecla Up (29)** o **Down (27)**

Control de los parámetros de soldadura

Los valores teóricos y reales de las temperaturas AIR y PLAST se controlan constantemente. Si un valor real es diferente al valor teórico correspondiente (valor fuera del rango de tolerancia), se señalará en el **indicador de estado (30)** mediante un cambio de estado. Si es necesario, se bloqueará el motor de accionamiento de forma provisional hasta que los parámetros de soldadura vuelvan al rango de tolerancias definido. Los estados posibles y los rangos de tolerancia se muestran en el siguiente gráfico y en la tabla.

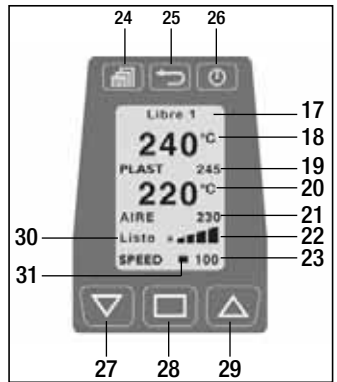

ejemplo

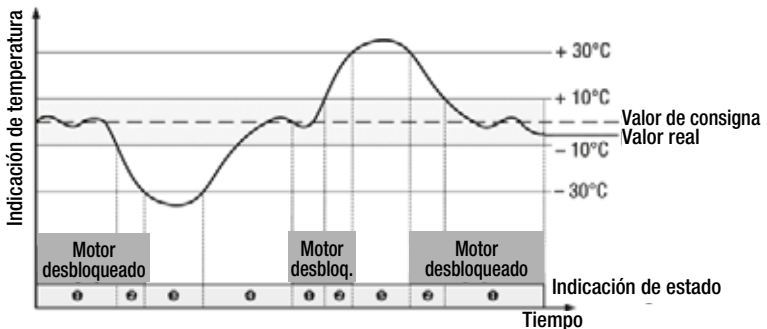
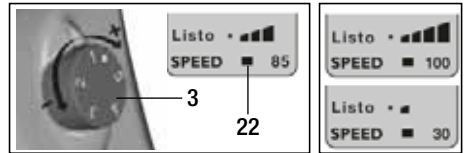

N.º	Indicador de estado	Propiedades de estado
1	Listo*	Listo para la soldadura
2	M libre	Divergencia de los parámetros de soldadura (plástico) > 10 °C
3	Calentar	Divergencia de los parámetros de soldadura (plástico) > -30 °C, motor de accionamiento bloqueado
4	3s	Tiempo inicial de bloqueo de 30 s, motor de accionamiento bloqueado
5	demasiado caliente	Divergencia de los parámetros de soldadura > +30 °C, motor de accionamiento bloqueado

Inicio del proceso de soldadura

- En caso necesario, montar la **zapata de soldadura (8)** correspondiente
- Ajustar el **potenciómetro (3)** al máximo
- Cuando se alcance la temperatura de funcionamiento (estado Listo*), se puede comenzar la soldadura
- Pulsar el **interruptor de conexión y desconexión del accionamiento (2)**
- Introducir un alambre para soldar con un diámetro de 3 o 4 mm en la **entrada del alambre de soldadura (12)**
- El alambre para soldar entrará automáticamente en la **entrada del alambre de soldadura (12)**. El alambre se debe introducir sin resistencia.



¡ATENCIÓN!

Utilizar el dispositivo siempre con el alambre para soldar, pero nunca introducir el alambre para soldar al mismo tiempo en ambas entradas.

- Interrumpir la salida de material con el **interruptor de conexión y desconexión del accionamiento (2)**
- Orientar la **boquilla de precalentamiento (9)** a la zona de soldadura
- Precalentar la zona de soldadura con movimientos oscilantes
- Colocar el dispositivo en la zona de soldadura lista y volver a pulsar el **interruptor de conexión y desconexión del accionamiento (2)**
- Realizar una soldadura de prueba conforme a las instrucciones de soldadura del fabricante del material y las normas o directivas nacionales
- Comprobar la soldadura de prueba
- Adaptar el ajuste de temperatura y la cantidad de extrusión según sea necesario
- En caso de un procedimiento de soldadura largo, el **interruptor de conexión y desconexión del accionamiento (2)** se puede mantener en funcionamiento continuo con el **bloqueo de accionamiento (4)**.

WELDPLAST S2 - PVC

- El PVC-U sólo se puede procesar en el menú de PVC-U. ATENCIÓN: Utilice únicamente PVC-U (no PVC-C)
- Para evitar la corrosión se recomienda llenar el dispositivo con PE-HD si no se va a utilizar por un período prolongado (a partir de 2 días).

Parámetros de soldadura

Menú	
Seleccionar programa	
Selección	
Entrada	

Programa: El indicador de los materiales puede variar en función de la versión del equipo y del software.

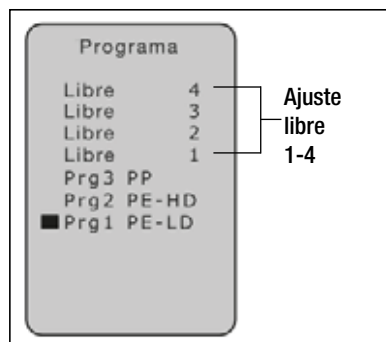

Los **programas 1 – 3** disponen de parámetros predefinidos que se pueden adaptar durante el proceso de soldadura.

Los cambios no se guardarán.

Los ajustes libres 1 – 4 están predefinidos de fábrica y se pueden programar libremente. Los parámetros seguirán guardados tras desconectar el dispositivo.

Programa de soldadura	Nominal PLAST [°C]	Nominal AIR [°C]
Ajuste libre 1 – 4	230	260
Prg1 PE-LD	220	260
Prg2 PE-HD	230	260
Prg3 PP	240	260
Prg0 PVC-U	200	300

El **programa de soldadura (17)** ajustado actualmente aparecerá en la ventana de trabajo. El indicador de los materiales puede variar en función de la versión del equipo y del software.

Ajuste de la cantidad de extrusión

- Con la **tecla Select (28)** colocar el cursor en la posición «SPEED»
- El valor de rendimiento (de 30 a 100%) se ajustará con la **tecla Up (29)** o **Down (27)**

Ajuste de las temperaturas PLAST y AIR

- Con la **tecla Select (28)** colocar el cursor en la posición «PLAST» o «AIR»
- El valor de temperatura se ajustará con la **tecla Up (29)** o **Down (27)**

Desconexión del dispositivo

- Liberar el **bloqueo de accionamiento (4)** y soltar el **interruptor de conexión y desconexión (2)**. Retirar el material de soldadura de la zapata de soldadura para que esta no se dañe la próxima vez que se arranque.
- Apagar la calefacción con la **tecla Standby/Enter (26)**
- Dejar que el dispositivo se enfríe durante aprox. 5 minutos
- Apagar el **interruptor principal (1)**

Otros ajustes

Ajuste de contraste



En caso de malas condiciones luminosas y de oscilaciones de la temperatura ambiental, el contraste se puede ajustar a través de la **tecla Back (25)**.



Calefacción ON/OFF

En caso de una interrupción prolongada (Standby), la calefacción para PLAST y AIR se puede desconectar a través de la **tecla Standby/Enter(26)**.

Activar bloqueo de teclas

1. Menú 
2. Bloqueo de teclas 
3. Activar 

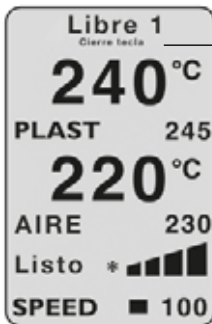

Si se activa el bloqueo de teclas, en la pantalla aparece **Bloqueo de teclas**.



Bloqueo de teclas activado

El bloqueo se puede cancelar de la siguiente forma:

Desactivar bloqueo de teclas

1. Back 
2. Restablecer 
3. Seleccionar 

La tecla Select deberá pulsarse inmediatamente después de restablecer.

Menús

Menú

Menú 

Selección  

Seleccionar 

Funciones

Selección  

Seleccionar y volver 

Volver a la selección de la ventana de trabajo 

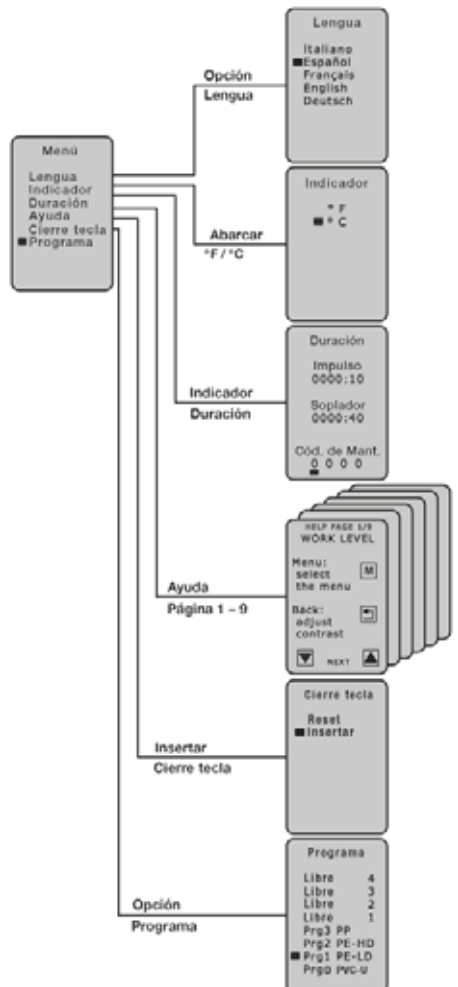

Mensajes de error

Si se produce un error, este aparecerá en el **indicador de estado (30)** (por ejemplo, **Err04** Motor sobrecalentado).

Indicador **ErrXX**

Al producirse un error, se desconectarán las calefacciones para AIR y PLAST, así como el motor de accionamiento. Si esto no se produce, se deberá desconectar inmediatamente el dispositivo de la red.

Otros procedimientos en caso de aparecer un error en el indicador de estado de accionamiento (30) **ErrXX**

- Anotar el código de error
- Liberar el **bloqueo de accionamiento (4)** y soltar el **interruptor de conexión y desconexión (2)**
- Desconectar el **interruptor principal (1)**
- Poner de nuevo el dispositivo en funcionamiento con supervisión y comprobar que la extrusora manual no se sobrecaliente desde fuera
- Retirar, si es posible, el plástico que permanezca en el tornillo sinfín
- En caso de que se vuelva a producir el error, se deberá enviar el dispositivo al servicio técnico para su inspección indicando el código de error

El dispositivo reconoce los siguientes fallos:

Indicación	Tipo de fallo
Err01	Sobretemperatura del aire o sonda de temperatura defectuosa
Err02	Sobretemperatura de la masa de plástico o sonda de temperatura defectuosa
Err04	Sobretemperatura en el desarrollo del motor, motor sobrecalentado
Err08	Sobretemperatura del elemento calentador AIR o avería del motor del soplante
Err10	Sobretemperatura del circuito electrónico
Err40	Cortocircuito de la sonda de temperatura PLAST

En caso de que se produzcan varios fallos al mismo tiempo, por ejemplo, **Err02** y **Err04**, se mostrará **Err06**.

Otras combinaciones se mostrarán con las letras A, B, C, D, E y F, por ejemplo, **Err08** y **Err02** indicación **Err0A**.

Protección frente a temperatura excesiva del accionamiento

Si el accionamiento se calienta demasiado por influencias externas o por una temperatura de PLAST demasiado baja, se desconecta la protección de temperatura interna del accionamiento (vea **Err04**).

Protección de re arranque del accionamiento

El motor de accionamiento está protegido contra re arranques autónomos tras errores, por ejemplo, sobretemperatura **Err04**. Aparece en la **pantalla (5)** la indicación «Desconectar accionamiento», mientras el motor de accionamiento permanece en estado bloqueado. Tras resolver el problema y desconectar el accionamiento (liberar el **bloqueo de accionamiento (4)** y soltar el **interruptor de conexión y desconexión del accionamiento (2)**) se apagará la indicación „Desconectar accionamiento“ en la **pantalla (5)**. Se puede continuar trabajando.

Cambio de accesorios



¡Peligro de quemaduras!



Trabajar sólo con guantes de protección térmica.

Cambio de la zapata de soldadura

El cambio de la zapata de soldadura se debe realizar con el dispositivo aún caliente.

Desmontaje

- Apagar el dispositivo aún caliente y desenchufarlo de la red eléctrica
- Retirar la **zapata de soldadura (8)** de la **boquilla de extrusión (32)** junto con el **soporte de zapata (34)** aflojando los **tornillos de fijación (35)**
- Limpiar los restos de soldadura de la **boquilla de extrusión (32)** en cada cambio de zapata y comprobar que esté firmemente atornillada
- Retirar la **zapata de soldadura (8)** aflojando los **tornillos de sujeción (33)** del **soporte de zapata (34)**

Montaje

- Montar una de las **zapatas de soldadura (8)** adaptadas a la costura en el **soporte de zapata (34)** con los **tornillos de sujeción (33)**
- La **zapata de soldadura (8)** y el **soporte de zapata (34)** deben estar bien sujetos con **tornillos de fijación (35)**

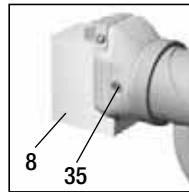
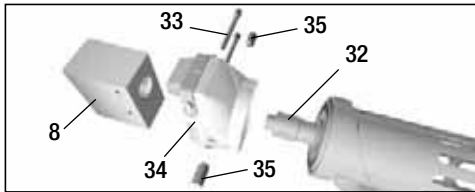

- 8 Zapata de soldadura
- 32 Boquilla de extrusión
- 33 Tornillos de sujeción
- 34 Soporte de patín
- 35 Tornillo de fijación

Dirección de soldadura

Aflojando los **tornillos de fijación (35)** se puede girar la **zapata de soldadura (8)** sin escalas a la dirección de soldadura deseada. Se deben volver a apretar bien los **tornillos de fijación (35)**.

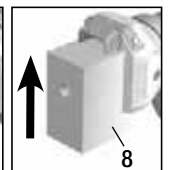
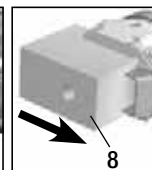
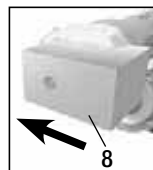

Cambio del conducto de aire caliente

Para desmontar el **conducto de aire caliente (44)** se debe retirar primero la **zapata de soldadura (8)**. Tras aflojar el **tornillo con contratuerca (45)** de la **abrazadera de tubo (10)** y el **tornillo de fijación (47)** de la conexión del conducto de aire caliente, se puede extraer toda la unidad.

Montaje en orden inverso.

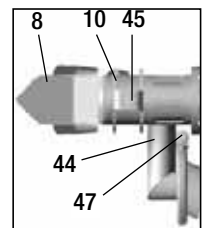

Cambio de la boquilla de precalentamiento

Desmontaje: Aflojar el **tornillo de fijación (43)** de la **boquilla de precalentamiento (9)** y retirarla del **conducto de aire caliente (44)**.

Montaje: Colocar la **boquilla de precalentamiento (9)** sobre el **conducto de aire caliente (44)**.

Compruebe que la orientación sea paralela a la zapata de la boquilla. Apretar el **tornillo de fijación (43)**.

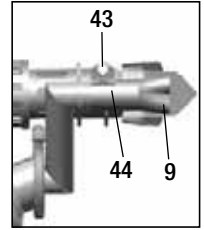

Boquillas de precalentamiento para equipos con conducto de aire externo

Se puede elegir entre tres **boquillas de precalentamiento (9)** diferentes en función de la anchura de la costura de soldadura. Las secciones transversales de las boquillas cumplen las directivas DVS.



Gama de zapatas de soldadura

Leister Technologies AG ofrece para todas las formas de costura habituales zapatas de soldadura correspondientes en diferentes tamaños:

WELDPLAST S2 / WELDPLAST S2-TPO con conducto de aire integrado

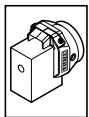

Pieza bruta



Costura V



Costura en ángulo

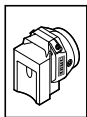

Costura solapada

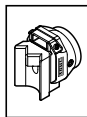

Soldadura de esquina exterior

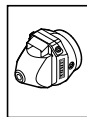

Soldadura de esquina corta



Soldadura de esquina larga

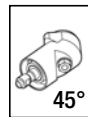

Tobera angulada

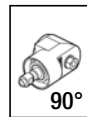

90°

WELDPLAST S2 / WELDPLAST S2-PVC con conducto de aire externo

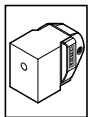

Pieza bruta

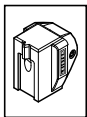

Costura V

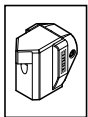

Costura en ángulo



Costura solapada

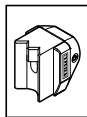

Soldadura de esquina exterior

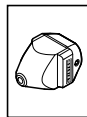

Soldadura de esquina corta

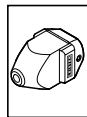

Soldadura de esquina larga

Accesorios

Sólo pueden utilizarse **accesorios Leister**.

Soporte del aparato



Dispositivo portátil de desbobinado de alambre

- El dispositivo está diseñado para rollos de alambre de soldadura con \varnothing 300 mm
- Para garantizar un desbobinado correcto del alambre, se debe guiar el alambre de soldadura a través del **ojal (41)** previsto

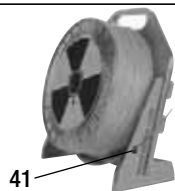

Mantenimiento

- Controlar que el **cable de conexión de red (14)** y el enchufe no tengan daños mecánicos ni eléctricos
- Retirar los restos de soldadura de la **boquilla de extrusión (32)** en cada cambio de zapata de soldadura

Servicio y reparaciones

- Las reparaciones se realizarán únicamente en **oficinas de servicio técnico autorizadas por Leister**. Estas garantizan un **servicio de reparación** fiable y especializado **durante 24 horas** con piezas de repuesto originales conforme a los planos de conexiones y las listas de piezas de repuesto.
- Si al conectar el dispositivo aparece en WELDPLAST S2 el indicador de servicio con el **código de servicio 1**, una **oficina de servicio autorizada de Leister** deberá controlar el estado de las escobillas de carbón del accionamiento y sustituir las en caso necesario.
- El indicador se puede volver a ocultar con la **tecla Select (28)** .
- Con la extrusora manual se puede continuar trabajando un período breve.
- Si no se cambian las escobillas de carbón en un período determinado, el accionamiento se moverá hasta alcanzar la parada mecánica de carbón. No aparece ningún mensaje de error en el indicador, pero el accionamiento deja de funcionar.



Garantía

- Para este dispositivo tienen validez los derechos de garantía comercial o legal concedidos por el socio de distribución directo/el vendedor a partir de la fecha de compra. En caso de que exista derecho de garantía comercial o legal (certificación mediante factura o albarán de entrega), el socio de distribución subsanará los daños de fabricación o tratamiento con una entrega de reposición o una reparación. Las resistencias están excluidas de la garantía.
- Cualquier otro derecho de garantía comercial o legal se excluirá en el marco del derecho imperativo.
- Los daños provocados por el desgaste natural del equipo, sobrecarga o manejos inadecuados quedan excluidos de la garantía.
- No habrá ningún derecho de garantía comercial o legal en el caso de los dispositivos que hayan sido alterados o modificados por el comprador.



Bedieningshandleiding vóór de inwerkingstelling aandachtig lezen en voor later gebruik bewaren.

Leister WELDPLAST S2 / S2-PVC / S2-TPO Handextruder

Toepassing

Extrusielassen met de volgende materialen:

WELDPLAST S2 PP / PE-HD / PE-LD
WELDPLAST S2-PVC PP / PE-HD / PE-LD / PVC-U
WELDPLAST S2-TPO PP / PE-HD / PE-LD / TPO

Verdere materialen op aanvraag

De handextruder is in overeenstemming met DVS-norm 2207-4.

DVS: Deutscher Verband für Schweisstechnik (Duitse Bond voor Lastechniek)



Waarschuwing



Levensgevaar bij het openen van het apparaat, omdat onder spanning staande onderdelen en aansluitingen worden blootgelegd. Vóór het openen van het apparaat eerst de stekker uit het stopcontact trekken. Elektrisch geleidend materiaal (b.v. PE-EL) mag niet worden gelast.



Brand- en ontploffingsgevaar bij ondeskundig gebruik van de handextruder (b.v. oververhitting van materiaal) vooral in de buurt van brandbare materialen en explosieve gassen.



Verbrandingsgevaar ! Blanke metaalvlakken en naar buiten stromende massa niet in hete toestand aanraken. Het apparaat eerst laten afkoelen. Hete luchtstraal en naar buiten stromende massa niet op personen of dieren richten.



Sluit het apparaat **alleen aan een geaard stopcontact** aan. Elke onderbreking van de aardleiding binnen of buiten het apparaat is gevaarlijk!

Alleen verlengsnoeren met aardleiding gebruiken!



Veiligheid



De nominale spanning die op het apparaat staat aangegeven moet overeenkomen met de netspanning. Bij netuitval moeten hoofdschakelaar en aandrijving worden uitgeschakeld (arrêtering ontgrendelen).



Een aardlekschakelaar is bij het gebruik van het apparaat op bouwplaatsen ter beveiliging van personen dringend noodzakelijk.



Het apparaat **moet onder toezicht** in werking zijn. De warmte kan brandbare materialen bereiken die zich buiten zichtwijdte bevinden.

Het apparaat mag alleen door **daarvoor opgeleide technici** of onder toezicht van zulke personen worden gebruikt. Het is voor kinderen verboden dit apparaat te gebruiken.



Bescherm het apparaat tegen vocht en damp.

Conformiteit

Leister Technologies AG, Galileo-Strasse 10, CH-6056 Kaegiswil/Zwitserland bevestigt dat dit product in de door ons in omloop gebrachte uitvoering aan de eisen van de volgende EU-richtlijnen voldoet.

Richtlijnen: 2006/42
2004/108 (tot 19.04.2016), 2014/30 (vanaf 20.04.2016)
2006/95 (tot 19.04.2016), 2014/35 (vanaf 20.04.2016)
2011/65

Geharmoniseerde normen: EN 12100, EN 55014-1, EN 55014-2, EN 61000-6-2, EN 61000-3-2,
EN 61000-3-3, EN 62233, EN 60335-1, EN 60335-2-45, EN 50581

Kaegiswil, 04-01-2016

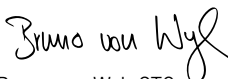
Bruno von Wyl, CTO

Andreas Kathriner, GM

Afvalverwijdering



Bied elektrisch werkende gereedschappen, toebehoren en verpakkingen aan voor milieuvriendelijk hergebruik. **Uitsluitend EU-landen:** Voer het lasapparaat niet af via de inzameling van huishoudelijk afval!

Technische gegevens

Spanning	V~	230	200
Vermogen	W	3000	2400
Frequentie	Hz	50/60	
Luchtstroom (20 °C)	l/min	300	
Luchttemperatuur	°C	max. 350	
Plastificeertemperatuur	°C	max. 260	
Opbrengst (Ø 3 mm)	kg/h	PE 0,6–1,3 PP 0,5–1,2 *PVC-U 0,9–1,7 (doorsneewaarden bij 50 Hz)	
Opbrengst (Ø 4 mm)	kg/h	PE 1,0–2,3 PP 0,9–2,0 *PVC-U 1,5–2,7 (doorsneewaarden bij 50 Hz)	
Lasdraad	mm	Ø 3 / Ø 4	
Maten L × B × H	mm	450 × 98 × 260 (zonder lasschoen)	
Gewicht	kg	5,8 (zonder netsnoer)	
Conformiteitsteken		CE	CE
Keurmerk		Ⓢ	
Beschermingsklasse I		Ⓢ	Ⓢ

* WELDPLAST S2-PVC

Technische wijzigingen voorbehouden

Beschrijving van het apparaat

Met externe luchtleiding

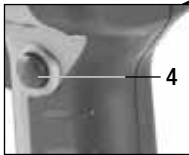
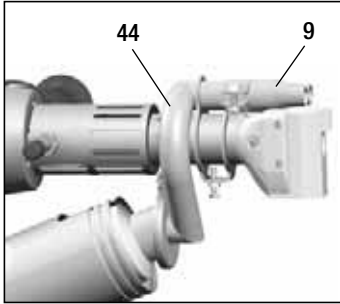

Met geïntegreerde luchtleiding

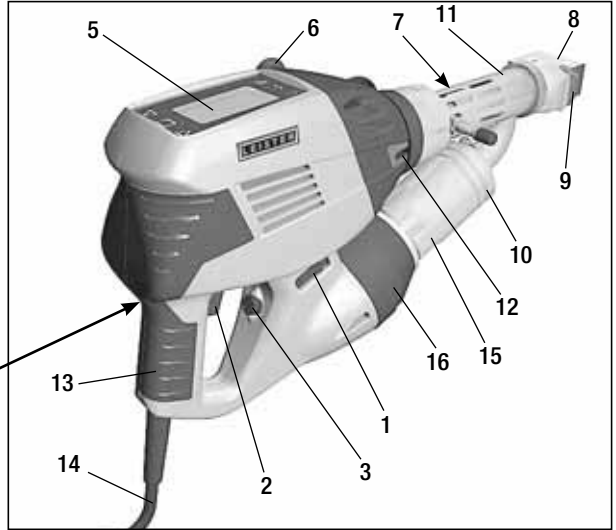

- 1 Hoofdschakelaar
- 2 Aan-/uitschakelaar aandrijving
- 3 Potentiometer
- 4 Arrêtering aandrijving
- 5 Display
- 6 Handgreep
- 7 Mantelverwarming
- 8 Lasschoen
- 9 Voorwarmmondstuk

- 10 Buisklem
- 11 Beschermhuis
- 12 Lasdraadinvoer
- 13 Spadegreep
- 14 Netkabel
- 15 Verwarmingselement met beschermhuis
- 16 Heteluchtblazer (borstelloos)
- 44 Externe heteluchtleiding

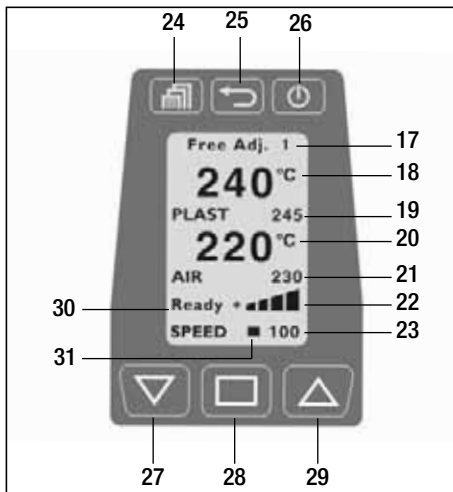

Bedieningseenheid

- 17 Lasprogramma
- 18 Actuele waarde Plast
- 19 Instelwaarde Plast
- 20 Actuele waarde Air
- 21 Instelwaarde Air
- 22 Intensiteitsbalk aandrijving
- 23 Display opbrengst
- 24 Menu-toets
- 25 Back-toets
- 26 Standby-/ enter-toets
- 27 Down-toets
- 28 Select-toets
- 29 Up-toets
- 30 Statusweergave aandrijving
- 31 Cursor

Werkomgeving / veiligheid



De handextruder mag niet in een ontvlambare omgeving of bij ontploffingsgevaar worden gebruikt. Let bij het werk op een stabiele lichaamshouding. Netkabel en lasdraad moeten goed beweegbaar zijn en mogen de gebruiker of derden niet bij het werk hinderen.



Handextruder op een vuurvaste onderlegger plaatsen! Hete metalen delen en de hete luchtstraal moeten voldoende afstand tot onderlegger en wanden houden.

Instelling handgreep

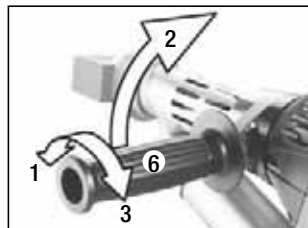

1. Door verdraaien van de **handgreep (6)** tegen de wijzers van de klok komt de klem los.
2. **Handgreep (6)** in de gewenste gebruikspositie brengen
3. Door verdraaien van de **handgreep (6)** in de richting van de klok klem weer vasttrekken.

Werkruimte



Voor de inwerkingstelling en het opbergen van de handextruder biedt Leister een **universele apparatensteun** aan.



Bij onderbreking van het laswerk moet de aandrijving met de **aan-/uitschakelaar aandrijving (2)** worden uitgeschakeld. De handextruder met daarvoor passend ingestelde en vast afbeelding op een stabiele, vuurvaste onderlegger plaatsen.

Verlengkabels

Bij gebruik van verlengkabels op de minimale doorsnede letten: Verlengkabel moet voor de plaats van gebruik (b.v. in de open lucht) toegelaten zijn en een dienovereenkomstig kenmerk dragen.

Bij gebruik van een noodstroomaggregaat als energiebron geldt hiervoor als nom. vermogen: $2 \times$ nom. vermogen van de handextruder.

Lengte [m]	Minimale doorsnede (bij 230V~) [mm ²]
tot 19	2,5
20 – 50	4,0

Lasvoorbereiding

De temperatuurbewaking verhindert het in werking zetten van de handextruder in koude toestand.

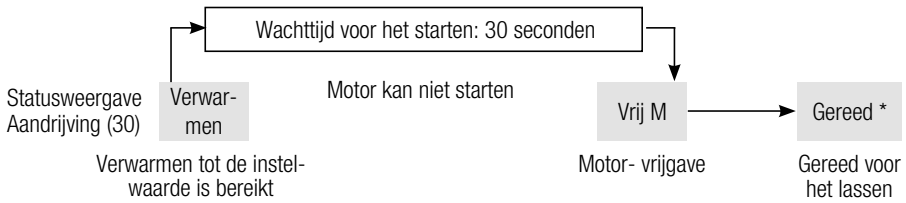

Het apparaat verwarmt direct na het inschakelen van de **hoofdschakelaar (1)** tot op de het laatst ingestelde temperaturen. Nadat de ingestelde temperaturen zijn bereikt, telt een counter in de statusweergave van 30 seconden terug naar nul. Na afloop van deze startprocedure is het apparaat gereed voor het lassen (Status Gereed*). De handextruder bereikt zijn bedrijfstemperatuur na ca. 4 minuten.

Bij een korte netspanningsonderbreking is een nieuwe startprocedure onnodig.

Software en menu-navigatie

De handextruder Weldplast S2 is met een comfortabele bedieningssoftware uitgerust, die de gebruiker het werk vergemakkelijkt. De toetsen reageren op een licht aantippen.

	Functies procesvenster	Functies menuselectie
	Menuselectie	Menuselectie / terug naar het procesvenster
	Contrast instellen	Terug naar het procesvenster (verandering wordt niet opgeslagen!)
	Verwarming on/off	Selecteren en terug naar het procesvenster
	Cursorpositie veranderen	Selecteren
	Geselecteerde waarde [+]	Cursor naar boven / geselecteerde waarde [+]
	Geselecteerde waarde [-]	Cursor naar onder / geselecteerde waarde [-]

Startvenster

Op de display worden na het inschakelen van de handextruder met de **hoofdschakelaar (1)** de naam van het apparaat en de actuele softwareversie 3 sec. lang weergegeven.



Procesvenster

Op het procesvenster worden de actueel ingestelde parameters weergegeven.

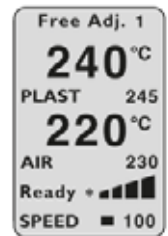

Instellen van de parameters in het procesvenster

De **cursor (31)** geeft aan welke parameters kunnen worden ingesteld. Na het inschakelen bevindt de cursor zich op de positie «SPEED». Met de **Select-toets (28)** kunnen «AIR» of «PLAST» worden geselecteerd en met de **Up-toets (29)** of **Down-toets (27)** in waarde worden veranderd.

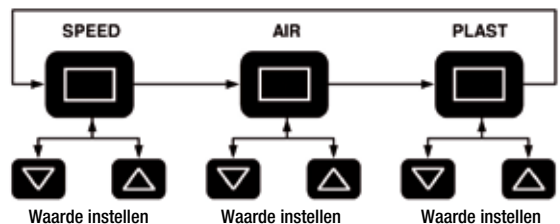

Lasvoorbereiding

Instellen van de massastroom („opbrengst“)

Afhankelijk van de naadvorm kunnen opbrengst en voorwarmtijd op elkaar worden afgestemd.

- Voorinstelling op de display
 - Door het indrukken van de **Select-toets (28)** de cursor naar de positie «SPEED» bewegen.
 - De maximale opbrengstwaarde (30 tot 100 %) via de **Up-toets (29)** of **Down-toets (27)** vastleggen (wordt met de **intensiteitsbalk Aandrijving (22)** weergegeven)
- Fijninstelling tijdens het lasproces
 - Vanaf de maximaal ingestelde opbrengstwaarde (b.v. 85%) kan door verdraaien van de **potentiometer (3)** die werkelijke opbrengst tot op het minimum worden gereduceerd

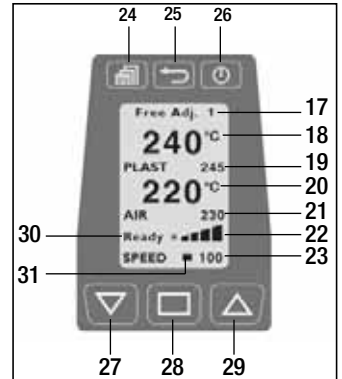

De opbrengst is afhankelijk van de toegepaste lasdraaddikte. Is de opbrengst met opbrengstweergave «30» en potentiometerstand «Minimum» te groot, dan moet naar een kleinere lasdraaddikte worden gewisseld.

Voorbeeld

Instellen van de PLAST- en AIR-temperaturen

- Door het indrukken van de **Select-toets (28)** de cursor naar de positie «PLAST» of «AIR» bewegen
- Temperatuur via de **Up-toets (29)** of **Down-toets (27)** instellen

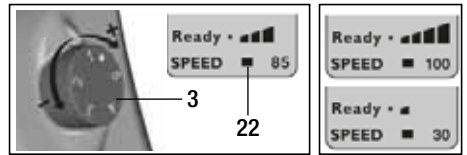

Bewaking van de lasparameters

De ingestelde en actuele waarden voor AIR- en PLAST-temperaturen worden voortdurend bewaakt. Wanneer een actuele waarde van de betreffende instelwaarde afwijkt (waarde ligt buiten de tolerantiezone), dan wordt dit met de **statusweergave (30)** door een statusverandering gesignaleerd. Indien nodig wordt de aandrijfmotor tijdelijk uitgeschakeld, tot de lasparameters weer binnen de vastgelegde tolerantiezone liggen. De mogelijke statusindicatoren en de tolerantiezones kunnen in de volgende grafiek en tabel worden gevonden.

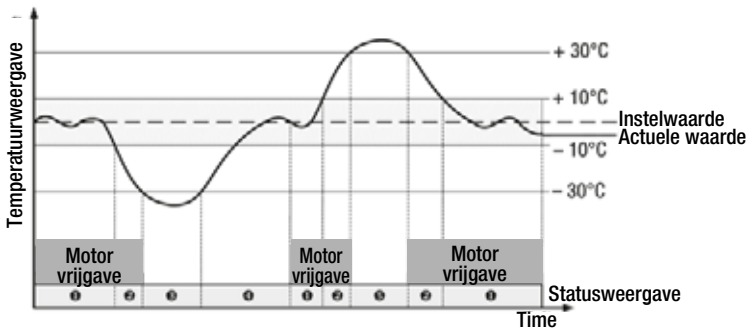

No	Statusindicator	Status-eigenschappen
①	Gereed*	Gereed om te lassen
②	Vrij M	Afwijking van de lasparameters (plastic) > 10°C
③	Verwarmen	Afwijking van de lasparameters (plastic) > -30°C, aandrijfmotor uitgeschakeld
④	30s	Wachttijd voor het starten 30 sec., aandrijfmotor uitgeschakeld
⑤	Te heet	Afwijking van de lasparameters > +30°C, aandrijfmotor uitgeschakeld

Starten van het lasproces

- Indien nodig de passende **lasschoen (8)** monteren
- **Potentiometer (3)** op max. instellen
- Nadat de bedrijfstemperatuur is bereikt (status Gereed*) kan met het lassen worden begonnen.
- **Aan-/uitschakelaar aandrijving (2)** indrukken
- Lasdraad met diameter 3 of 4 mm in de **lasdraad invoer (12)** steken
- De lasdraad wordt automatisch door de **lasdraad invoer (12)** naar binnen getrokken. De draadtoevoer moet zonder weerstand plaatsvinden



OPGELET!

Apparaat altijd met lasdraad in werking houden, maar nooit in beide invoerpunten tegelijk lasdraad invoeren.

- Massatransport met de **aan-/uitschakelaar aandrijving (2)** onderbreken
- Het **voorwarmmondstuk (9)** op de laszone richten
- Met schommelende bewegingen de laszone voorwarmen
- Het apparaat op de voorbereide laszone plaatsen en de **aan-/uitschakelaar aandrijving (2)** weer indrukken.
- Testlas volgens lashandleiding van de materiaalafabrikant en volgens de nationale normen of richtlijnen uitvoeren.
- Testlas controleren
- Temperatuurinstelling en opbrengst zo nodig aanpassen
- Bij een langer lasproces kan de **aan-/ uitschakelaar aandrijving (2)** d.m.v. de arrêtering van de **aandrijving (4)** op permanente functie worden geschakeld.

WELDPLAST S2 - PVC

- PVC-U mag alleen met het menu PVC-U worden verwerkt. OPGELET: Alleen PVC-U gebruiken (geen PVC-C!)
- Om corrosie te voorkomen wordt aanbevolen het apparaat bij langer buiten gebruik zijn (vanaf 2 dagen) met HD-PE te vullen.

Lasparameters

Menu	
Programma selecteren	
Selectie	 
Invoer	

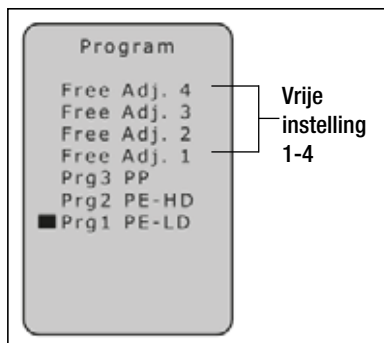

Programma: De benaming van de materialen kan afwijken, afhankelijk van de apparaten- en software-uitvoering.

De programma's 1 – 3 zijn met bepaalde voorinstelde parameters vastgelegd, die tijdens het lasproces kunnen worden aangepast.

De aanpassingen worden niet opgeslagen!

De vrije instellingen 1 – 4 zijn door de fabriek voorinsteld en kunnen vrij worden geprogrammeerd. De parameters blijven ook na het uitschakelen van het apparaat actief.

Lasprogramma	Gewenste PLAST [°C]	Gewenste AIR [°C]
Vrije inst. 1 – 4	230	260
Prg1 PE-LD	220	260
Prg2 PE-HD	230	260
Prg3 PP	240	260
Prg0 PVC-U	200	300

Het actueel ingestelde **lasprogramma (17)** is op het procesvenster te lezen.

De aangegeven materialen kunnen afwijken, afhankelijk van apparaat- en softwareuitvoering.

Instellen van de opbrengst

- Door het indrukken van de **Select-toets (28)** de cursor naar de positie «SPEED» bewegen.
- De opbrengstwaarde (30 tot 100 %) met de **Up-toets (29)** of **Down-toets (27)** instellen.

Instellen van de PLAST- en AIR-temperatuur

- Door indrukken van de **Select-toets (28)** de cursor naar de positie «PLAST» of «AIR» bewegen.
- De temperatuurwaarde met de **Up-toets (29)** of **Down-toets (27)** instellen.

Uitschakelen van het apparaat

- **Arrêtering aandrijving (4)** ontgrendelen en de **aan-/uitschakelaar aandrijving (2)** loslaten.
Lasmateriaal uit de lasschoen verwijderen, zodat de lasschoen bij het volgende starten niet wordt beschadigd
- Verwarmingen met **Standby-/ Enter-toets (26)** uitschakelen.
- Apparaat ca. 5 min. laten afkoelen
- **Hoofdschakelaar (1)** uitschakelen

Verdere instellingen

Contrastinstelling



Bij ongunstige verlichting en fluctuaties in de omgevingstemperatuur kan het contrast met de **Back-toets (25)** worden ingesteld.

Verwarming ON/OFF



Bij langere onderbreking (Standby) kan de verwarming voor PLAST en AIR met de **Standby-/Enter-toets (26)** worden uitgeschakeld.

Toetsenblokkering activeren

1. Menu



2. Toetsenblokkering



3. Activeren



Wanneer de toetsenblokkering werd geactiveerd, verschijnt op de display **Toetsenblokk.**

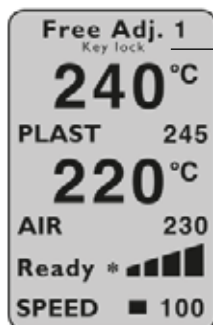

Toetsenblokkering geactiveerd

De blokkering kan als volgt weer worden opgeheven:

Toetsenblokkering deactiveren

1. Back



2. Terugzetten



3. Selecteren



De bediening met de Select-toets moet onmiddellijk na het terugzetten plaatsvinden!

Menunavigatie

Menu



Menu

Selectie



Selecteren



Functies

Selectie



Selecteren en terug



Terug naar het procesvenster Selectie

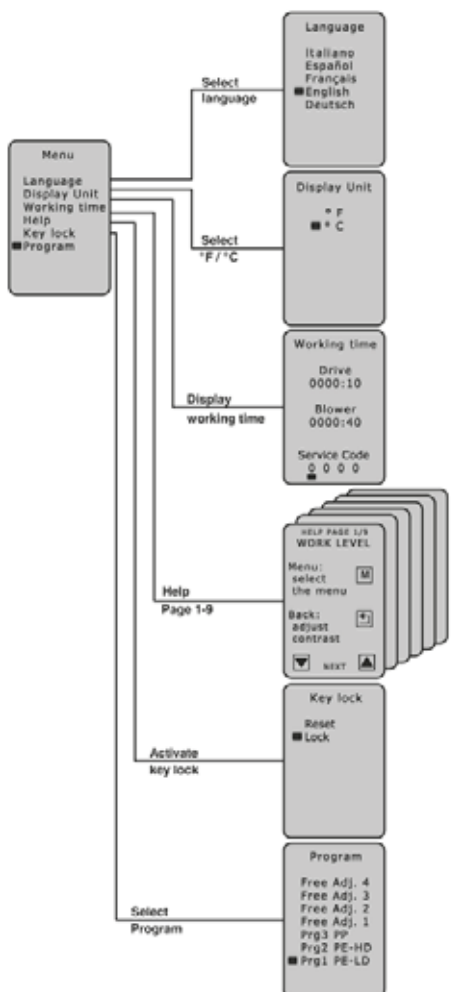

Storingsmeldingen

Wanneer er een storing optreedt, wordt die in de **statusweergave (30)** gemeld (b.v. **Err04** Motor is oververhit).

Display **ErrXX**

Bij het optreden van een storing worden de verwarmingen van AIR en PLAST, evenals de aandrijfmotor onmiddellijk uitgeschakeld! Mocht dit niet gebeuren, dan moet het apparaat onmiddellijk van het lichtnet worden gescheiden!

Verdere handelingen bij statusweergave Aandrijving (30) **ErrXX**

- Errorcode noteren
- **Arrêtering aandrijving (4)** ontgrendelen en de **aan-/uitschakelaar aandrijving (2)** loslaten
- **Hoofdschakelaar (1)** uitschakelen
- Het apparaat nog eens onder toezicht in werking stellen en er op letten, dat de handextruder niet van buiten oververhit wordt
- De in de wormschroef achtergebleven kunststof indien mogelijk verwijderen
- Indien de storing weer optreedt, moet het apparaat onder vermelding van de errorcode ter controle naar het servicepunt worden opgestuurd

De volgende storingen worden door het apparaat herkend:

Display	Type storing
Err01	Te hoge luchttemperatuur of defecte temperatuursonde
Err02	Te hoge temperatuur van de kunststofmassa of defecte temperatuursonde
Err04	Te hoge temperatuur in de motorwikkeling, motor is oververhit
Err08	Te hoge temperatuur van het verwarmingselement AIR of defect van de ventilatormotor
Err10	Te hoge temperatuur van de elektronica
Err40	Kortsluiting van de temperatuursonde PLAST

Indien meerdere storingen gelijktijdig optreden, b.v. **Err02** en **Err04**, dan wordt **Err06** gemeld.

Verdere combinaties worden met de letters A, B, C, D, E en F weergegeven,

b.v. **Err08** en **Err02** veroorzaken **Err0A**.

Temperatuurbeveiliging Aandrijving

Wordt de aandrijving door externe invloeden of bij te lage PLAST-temperatuur oververhit, dan schakelt de interne temperatuurbeveiliging de aandrijving uit (zie **Err04**).

Startbeveiliging Aandrijving

De aandrijfmotor is beveiligd tegen zelfstandig starten na storingen, b.v. oververhitting **Err04**. Op de **display (5)** verschijnt dan de melding «Aandrijving uitschakelen», terwijl de aandrijfmotor in geblokkeerde toestand blijft. Na het verhelpen van de storing en het uitschakelen van de aandrijving (**arrêtering aandrijving (4)** ontgrendelen en de **aan-/uitschakelaar aandrijving (2)** loslaten) verdwijnt de melding «Aandrijving uitschakelen» van de **display (5)**. Het werk kan worden voortgezet.

Wisselen van toebehoren of accessoires



Verbrandingsgevaar!



Alleen met hittebestendige handschoenen werken.

Uitwisselen van de lasschoen

Het uitwisselen van de lasschoen moet bij bedrijfswarm apparaat worden uitgevoerd.

Demontage

- Het bedrijfswarme apparaat uitschakelen en van het lichtnet scheiden
- De **lasschoen (8)** met de **lasschoenhouter (34)** door het losdraaien van de **klemschroeven (35)** van het **extrudeermondstuk (32)** verwijderen
- Het **extrudeermondstuk (32)** bij elke lasschoenwissel reinigen van lasmateriaalresten en ervoor zorgen dat het goed vastgeschroefd is
- **Lasschoen (8)** door losschroeven van de **bevestigingsschroeven (33)** van de **lasschoenhouter (34)** verwijderen

Montage

- Een aan de lasnaad aangepaste **lasschoen (8)** met **bevestigingsschroeven (33)** aan de **lasschoenhouter (34)** monteren
- **Lasschoen (8)** en **lasschoenhouter (34)** moeten met de **klemschroeven (35)** goed worden aangetrokken

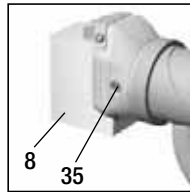
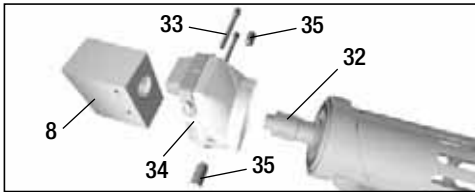

- 8 Lasschoen
- 32 Extrudeermondstuk
- 33 Bevestigingsschroef
- 34 Lasschoenhouter
- 35 Klemschroef

Lasrichting

Door het losdraaien van de **klemschroeven (35)** kan de **lasschoen (8)** traploos in de gewenste lasrichting worden gedraaid.

De **klemschroeven (35)** moeten daarna weer goed worden aangetrokken.

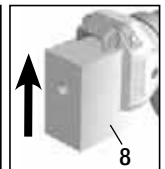
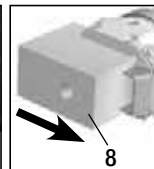
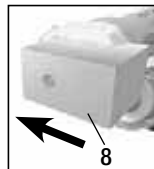

Uitwisselen van de heteluchtleiding

Voor de demontage van de **heteluchtleiding (44)** wordt eerst de **lasschoen (8)** verwijderd. Na het losdraaien van de geborgde **bevestigingsschroef (45)** van de **buiskleem (10)** en de **klemschroef (47)** van de verbinder-heteluchtleiding kan de gehele eenheid worden weggetrokken.

Montage in omgekeerde volgorde.

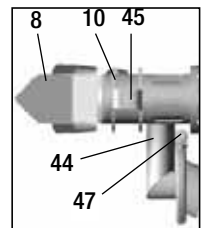

Uitwisselen van het voorwarmmondstuk

- Demontage: **Klemschroef (43)** bij het voorwarmmondstuk losdraaien en **voorwarmmondstuk (9)** van de **heteluchtleiding (44)** aftrekken.
- Montage: **Voorwarmmondstuk (9)** op de **heteluchtleiding (44)** schuiven. Let er op dat het mondstuk parallel aan de mondstukschoen wordt gemonteerd. **Klemschroef (43)** vasttrekken.

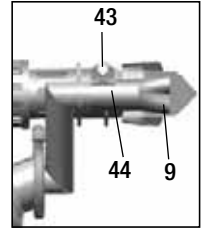

Voorwarmmondstukken voor apparaten met externe luchtleiding

Er staan drie verschillende **voorwarmmondstukken (9)** ter keuze, ieder voor verschillende lasnaadbreedten. De dwarsdoorsneden van de mondstukken zijn in overeenstemming met de DVS-richtlijnen.



Lasschoensortiment

Leister Technologies AG biedt voor alle gebruikelijke naadvormen de passende lasschoenen in diverse grootten aan:

WELDPLAST S2 / WELDPLAST S2-TPO met geïntegreerde luchtleiding

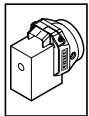

Onbewerkt



V-naad



Hoeklas

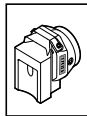

Overlapnaad

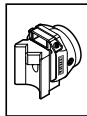

Hoeknaad buiten

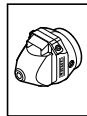

Hoeknaad kort



Hoeknaad lang

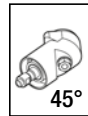

45°

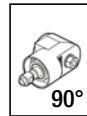

90°

Hoekkop

WELDPLAST S2 / WELDPLAST S2-PVC met externe luchtleiding

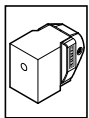

Onbewerkt

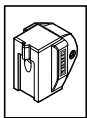

V-naad

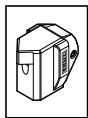

Hoeklas

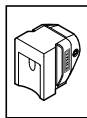

Overlapnaad

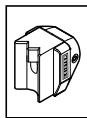

Hoeknaad buiten

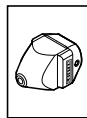

Hoeknaad kort

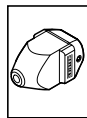

Hoeknaad lang

Toebehoren

Er mogen alleen **Leister-toebehoren** worden gebruikt.

Apparatensteun



Transporteerbaar draadafroltoestel

- Dit toestel is voor lasdraadrollen met \varnothing 300 mm ontworpen
- Om een optimale draadafwikkeling te waarborgen, moet de lasdraad door het daarvoor bedoelde **oog (41)** worden gevoerd.

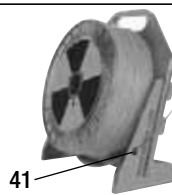

41

Onderhoud

- **Netkabel (14)** en stekker op elektrische en mechanische beschadigingen controleren.
- Het **extrudeermondstuk (32)** moet bij elke lasschoenwissel van lasmateriaalresten worden ontdaan.

Service en reparatie

- Reparaties mogen uitsluitend door geautoriseerde **Leister-servicepunten** worden uitgevoerd. Die waarborgen **binnen 24 uur** een vakkundige en betrouwbare **reparatieservice** met originele reserveonderdelen volgens de schakelschema's en reserveonderdeellijsten.
- Wanneer bij de WELDPLAST S2 na het inschakelen van het apparaat de servicemelding verschijnt met de **servicecode 1**, dan moeten de koolborstels van de aandrijving door een geautoriseerd **Leister-servicepunt** worden gecontroleerd en eventueel worden vervangen.
- De melding kan met de **Select-toets (28)**  weer worden gewist.
- Met de handextruder kan dan voor korte tijd nog worden doorgewerkt.
- Worden de koolborstels niet binnen korte tijd vervangen, dan loopt de aandrijving door tot het bereiken van het mechanische kooleinde. Op de display verschijnt dan geen storingsmelding, maar de aandrijving kan niet meer worden gestart.



Wettelijke garantie

- Voor dit apparaat gelden de door de directe salespartner/verkoper verleende garantie of de aanspraak op garantie vanaf de datum van aankoop. Bij een garantie of aanspraak op garantie (bewezen door de factuur of leveringsbewijs) de worden productie- of verwerkingfouten hersteld door de salespartner door middel van levering van vervangende onderdelen of reparatie. Verwarmingselementen zijn uitgesloten van de garantie of aanspraak op garantie.
- Verdere garantie of aanspraken op garantie worden in het kader van het dwingende recht uitgesloten.
- Schade als gevolg van normale slijtage, overbelasting of onachtzaam gebruik, is van de garantie uitgesloten.
- Geen garantie of aanspraak op garantie wordt verleend bij apparaten die door de koper zijn omgebouwd of veranderd.



Les bruksanvisningen nøye før igangsetting og oppbevar den for senere bruk.

Leister WELDPLAST S2 / S2-PVC / S2-TPO Hånd-ekstruderer

Bruk

Ekstrusjonssveising av følgende materialer:

WELDPLAST S2 PP / PE-HD / PE-LD

WELDPLAST S2-PVC PP / PE-HD / PE-LD / PVC-U

WELDPLAST S2-TPO PP / PE-HD / PE-LD / TPO

Ytterligere materialer ved forespørsel

Hånd-ekstruderens tilsvarer DVS-standarden 2007-4.

DVS: Deutscher Verband für Schweisstechnik (Tysk Forbund for Sveiseteknikk)



Advarsel



Det er livsfarlig å åpne enheten, da dette frilegger strømførende komponenter og koblinger. Før enheten åpnes skal støpselet trekkes ut av stikkontakten. Elektrisk ledende materiale (f.eks. PE-EL) må ikke sveises.



Brann- og eksplosjonsfare ved feilaktig bruk av hånd-ekstruderer (f.eks. overoppheting av materiale), særdeles i nærheten av brennbare materialer og eksplosive gasser.



Fare for forbrenning! Nakne metalldele og masse som strømmer ut må ikke berøres når de er varme. La enheten avkjøle seg. Varmluftstrålen og massen som strømmer ut må aldri rettes mot mennesker eller dyr.



Enheten skal kobles til en jordet stikkontakt. Hver avbrytelse av jordledningen innenfor eller utenfor enheten er farlig!

Bruk kun jordede skjøteledninger!



Forsikt



Apparatets spenning må være den samme som nettspenningen. Ved strømbrydd må hovedbryteren og motoren slås av (løsne låsemekanismen).



Jordet kontakt er absolutt nødvendig som personbeskyttelse når enheten brukes på arbeidsplasser.



Hold enheten under oppsikt ved bruk. Varme kan spre seg til brennbare materialer som befinner seg utenfor synsvidde.

Maskinen må kun brukes av utdannede fagfolk eller under deres oppsyn. Det er strengt forbudt for barn å bruke maskinen.



Enheten må beskyttes mot fuktighet og væte.

Samsvar

Leister Technologies AG, Galileo-Strasse 10, CH-6056 Kaegiswil/Switzerland erklærer, at dette produktet tilsvarende den markedsførte modellen i henhold til konstruksjon og utførelse, og oppfyller kravene i følgende EF-direktiver.

Direktivene:	2006/42 2004/108 (til 19.04.2016), 2014/30 (fra 20.04.2016) 2006/95 (til 19.04.2016), 2014/35 (fra 20.04.2016) 2011/65
Harmoniserte standarder:	EN 12100, EN 55014-1, EN 55014-2, EN 61000-6-2, EN 61000-3-2, EN 61000-3-3, EN 62233, EN 60335-1, EN 60335-2-45, EN 50581

Kaegiswil, 04.01.2016

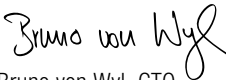
Bruno von Wyl, CTO

Andreas Kathriner, GM

Deponering



Elektroverktøy, tilbehør og emballasje skal resirkuleres på en miljøvennlig måte. **Kun for EU-land:** Kast aldri elektroverktøy i husholdni.

Tekniske data

Spenning	V~	230	200
Effekt	W	3000	2400
Frekvens	Hz	50/60	
Luftmengde (20°C)	l/min	300	
Lufttemperatur	°C	maks. 350	
Plastifiseringstemperatur	°C	maks. 260	
Ekstrudering (Ø 3 mm)	kg/h	PE 0.6–1.3 PP 0.5–1.2 *PVC-U 0.9–1.7 (gjennomsnittlige verdier ved 50 Hz)	
Ekstrudering (Ø 4 mm)	kg/h	PE 1.0–2.3 PP 0.9–2.0 *PVC-U 1.5–2.7 (gjennomsnittlige verdier ved 50 Hz)	
Sveisetråd	mm	Ø 3 / Ø 4	
Mål L x B x H	mm	450 x 98 x 260 (uten sveisesko)	
Vekt	kg	5.8 (uten strømledning)	
CE-merking	CE	CE	
Godkjenning	Ⓢ		
Beskyttelsesklasse I	Ⓢ	Ⓢ	

* WELDPLAST S2-PVC

Det tas forbehold om tekniske endringer

Beskrivelse

Med ekstern luftføring

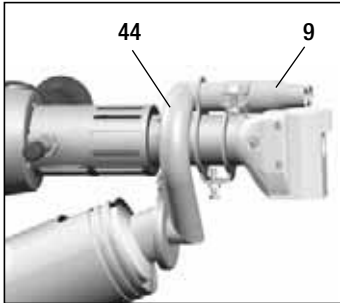

Med integrert luftføring

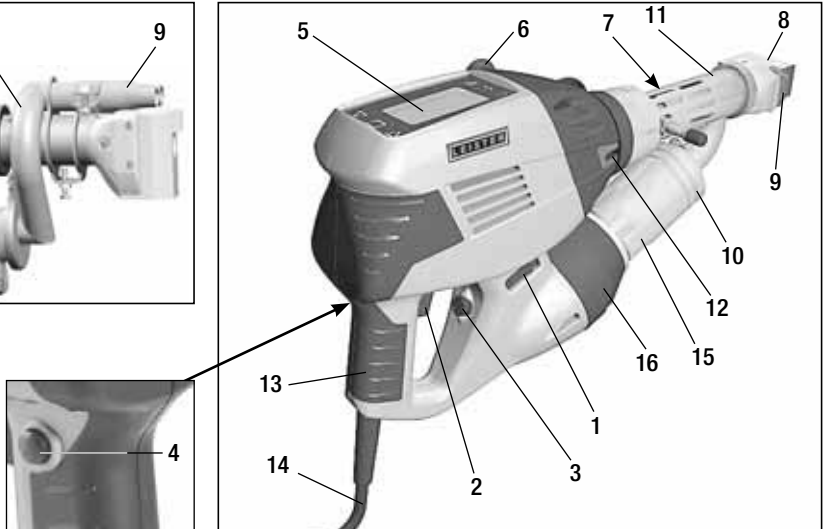

- 1 Hovedbryter
- 2 På-/Av-bryter motor
- 3 Potensiometer
- 4 Låsemekanisme motor
- 5 Display
- 6 Håndtak
- 7 Manteloppvarming
- 8 Sveisesko
- 9 Forvarmsdyse

- 10 Rørklemme
- 11 Beskyttelsesrør
- 12 Trådmater
- 13 Håndtak på enheten
- 14 Strømledning
- 15 Varmeelement beskyttelsesrør
- 16 Varmluftsapparat (børsteløs)
- 44 Ekstern varmluftføring

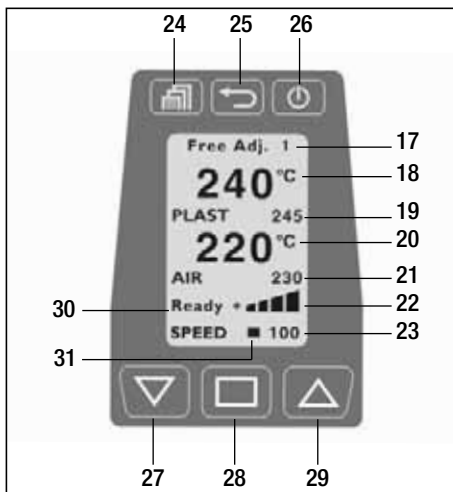

Betjeningsenhet

- 17 Sveiseprogram
- 18 Faktisk verdi Plast
- 19 Nominell verdi Plast
- 20 Faktisk verdi Air
- 21 Nominell verdi Air
- 22 Indikatorstolpe motor
- 23 Ekstruderingsindikator
- 24 Meny-tast
- 25 Back-tast
- 26 Standby-/ Enter-tast
- 27 Down-tast
- 28 Select-tast
- 29 Up-tast
- 30 Statusvisning motor
- 31 Markør

Arbeidssted / sikkerhet



Hånd-ekstruderen skal ikke brukes i eksplosjonsfarlige omgivelser, eller der det befinner seg antennelige materialer. Påse at enheten står støtt under arbeidet. Strømledning og sveisetråd må kunne bevege seg fritt og må ikke hindre brukeren eller andre personer under arbeidet.



Plasser hånd-ekstruderen på et ildfast underlag! Varme metalldele og varmluftstrålen må ha tilstrekkelig avstand til underlaget og vegger.

Innstilling håndtak

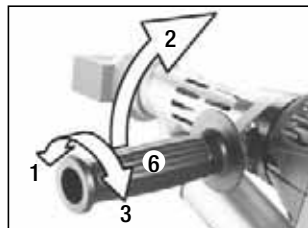

1. Løsne klemmingen ved å dreie **håndtaket (6)** mot urviseren
2. Plasser **håndtaket (6)** i den ønskede arbeidsposisjonen
3. Trekk klemmingen til igjen ved å dreie **håndtaket (6)** med urviseren

Arbeidsplass



For igangsettingen og for å legge bort utstyret, tilbyr Leister et **universalt maskinstativ**.



Når sveisearbeidene avbrytes, må motoren slås av med **På-/Av-bryteren (2)**. Hånd-ekstruderen skal plasseres på et stabilt, ildfast underlag og med innstilt og fast tiltrukket håndtak som vist i illustrasjonen.

Skjøteledning

Ved bruk av skjøteledninger må du være oppmerksom på minste tverrsnitt:

Skjøteledninger må være godkjent for brukerstedet (for eksempel utendørs) og ha en tilsvarende merking.

Ved bruk av et aggregat for energiforsyning, må dette ha en nominell effekt på: $2 \times$ nominell effekt hånd-ekstruder.

Lengde [m]	Minste tverrsnitt (ved 230V~) [mm ²]
Til 19	2.5
20 – 50	4.0

Forberedelse for sveising

Temperaturovervåkingen forhindrer at hånd-ekstruderen starter i kald tilstand.

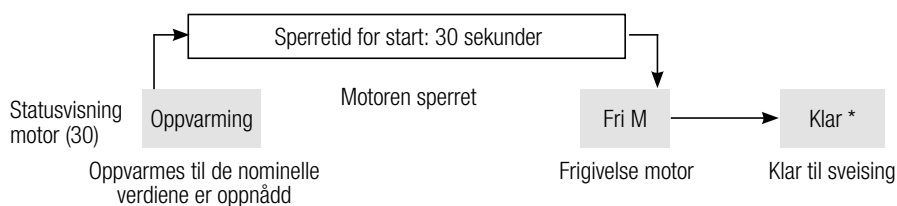

Etter at **hovedbryteren (1)** ble slått på, varmes ekstruderen varmes opp til den sist innstilte nominelle temperaturen. Når den nominelle temperaturen er oppnådd, teller en Counter i statusvisningen fra 30 sekunder tilbake til Null. Etter at denne startprosedyren er avsluttet, er ekstruderen klar til sveising (Status Klar*). Hånd-ekstruderen oppnår sin driftstemperatur etter ca. 4 minutter.

Ved kortvarig strøbrudd bortfaller en ny startprosedyre.

Programvare og meny navigering

Hånd-ekstruderen Weldplast S2 er utstyrt med en komfortabel brukerprogramvare, som letter arbeidet for brukeren. Tastene aktiveres ved en lett berøring.

	Funksjoner arbeidsvindu	Funksjoner menyvalg
	Menyvalg	Menyvalg / tilbake til arbeidsvinduet
	Innstille kontrast	Tilbake til arbeidsvinduet (endring blir ikke lagret!)
	Oppvarming on/off	Utvelgning og tilbake til arbeidsvinduet
	Endre markørposisjon	Utvelgning
	Utvalgt verdi [+]	Markør oppover / utvalgt verdi [+]
	Utvalgt verdi [-]	Markør nedover / utvalgt verdi [-]

Startvindu

Etter at hånd-ekstruderen ble slått på med **hovedbryteren (1)**, vises enhetens navn og den aktuelle programvareversjonen i displayet for 3 sek.



Arbeidsvindu

Arbeidsvinduet viser de aktuelt innstilte parametrene.



Innstilling av parametrene i arbeidsvinduet

Markøren (3) viser hvilke parametre man kan innstille. Etter innkoblingen befinner markøren seg på posisjonen «SPEED». Med **Select-tasten (28)** kan «AIR» eller «PLAST» velges og med **Up-tasten (29)** eller **Down-tasten (27)** kan verdiene endres.

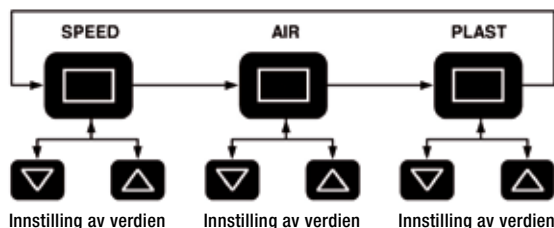

Forberedelse for sveising

Innstilling av ekstruderingsmengden

Med sveiseutformingen som grunnlag, kan ekstruderingsmengden og forvarmingstiden tilpasses hverandre.

- Forinnstillinger på displayet
 - Ved å trykke på **Select-tasten (28)**, stilles markøren på posisjonen «SPEED».
 - Den maksimale ekstruderingsverdien (30 til 100 %) blir bestemt via **Up-tasten (29)** eller **Down-tasten (27)** (vises via **indikatorstolpen (22)**)
- Fininnstilling under sveiseprosedyren
 - Fra maksimalt innstilt ekstruderingsverdi (f.eks. 85 %) kan ekstruderingsmengden reduseres til et minimum ved å dreie på **potensiometeret (3)**.

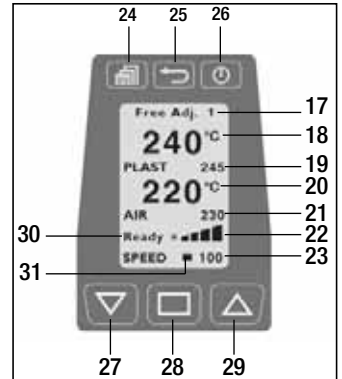

Ekstruderingsmengden er avhengig av den brukte sveisetrådykkelsen. Er ekstruderingsmengden med ekstruderingsindikatoren «30» og potensiometerstillingen «Minimum» for stor, må det skiftes til den neste, mindre sveisetrådykkelsen.

Innstilling av temperatur for PLAST og AIR

- Ved å trykke på **Select-tasten (28)**, kan markøren stilles på posisjonen «PLAST» eller «AIR».
- Still inn temperaturverdien via **Up-tasten (29)** eller **Down-tasten (27)**

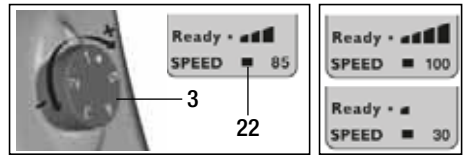

Eksempel

Overvåking av sveiseparametrene

De nominelle og faktiske verdiene til AIR- og PLAST-temperaturene overvåkes kontinuerlig. Dersom en faktisk verdi avviker fra den tilsvarende nominelle verdien (verdien ligger utenfor toleranseområdet), blir dette signalisert på **statusvisningen (30)** gjennom en statusveksel. Ved behov sperres drivmotoren midlertidig, til sveiseparametrene ligger i det spesifiserte toleranseområdet igjen. De mulige statusvisningene og toleransebåndene vises i det følgende diagrammet, hhv. tabellen.

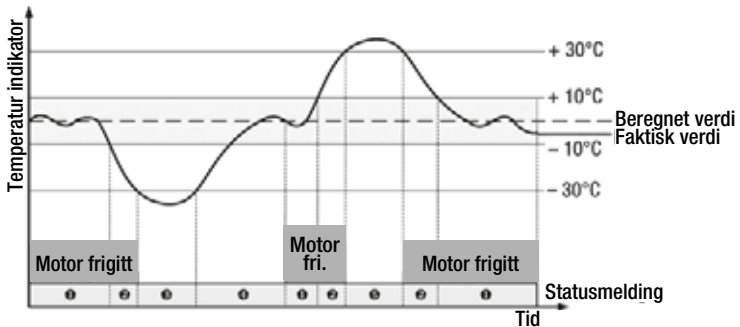

Nr	Statusvisning	Status-egenskaper
①	Klar*	Klar til sveising
②	Fri M	Avvik av sveiseparametrene (plastic) > 10 °C
③	Oppvarming	Avvik av sveiseparametrene (plastic) > - 30 °C, drivmotor sperret
④	30s	Sperretid for start på 30 sek., drivmotor sperret
⑤	for varm	Avvik av sveiseparametrene > + 30 °C, drivmotor sperret

Start av sveiseprosedyren

- Monter den tilsvarende **sveiseskoen (8)** etter behov
- Still inn **potensiometeret (3)** på maks.
- Når driftstemperaturen er nådd (Status Klar*), kan man begynne med sveisingen
- Aktiver **På/Av-bryter motor (2)**
- Før en sveisetråd med en diameter på 3 eller 4 mm inn i **trådmateren (12)**
- Sveisetråden blir dratt automatisk gjennom **trådmateren (12)**. Trådtilførselen må følge uten motstand



FORSIKT!

Enheten må alltid brukes med sveisetråd, men man må aldri føre sveisetråd inn i begge trådmaterne samtidig.

- Avbryt massetransporten med **På/Av-bryter motor (2)**
- **Forvarmingsdysen (9)** rettes mot sveisesonen
- Forvarm sveisesonen med pendlende bevegelser
- Plasser enheten på den forberedte sveisesonen og aktiver **På/Av-bryteren motor (2)** igjen.
- Foreta en testsveising i henhold til sveiseanvisningen fra materialprodusenten og nasjonale standarder eller direktiver.
- Kontrollerer testsveisingen
- Temperaturinnstillingen og ekstruderingsmengden tilpasses etter behov
- Ved en lengre sveiseprosedyre kan **På/v-bryter motor (2)** stilles på kontinuerlig drift ved hjelp av **låsemekanismen motor (4)**.

WELDPLAST S2 - PVC

- PVC-U skal kun bearbeides i PVC-U menyen. FORSIKT: Bruk kun PVC-U (ingen PVC-CI)
- For å unngå korrosjon, anbefaler vi å fylle enheten med HD-PE dersom den ikke brukes over lengre tid (fra 2 dager).

Sveiseparameter

Meny



Velge program



Utvalg



Inntasting

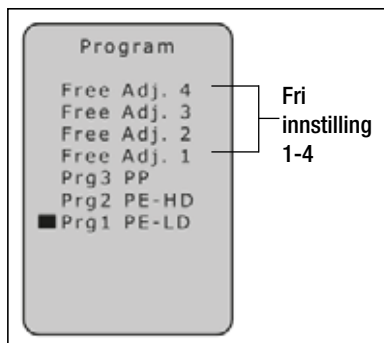

Program: Alt etter maskin- og programvareversjon, kan visningen av materialene avvike.

Programmene 1 – 3 er utstyrt med tilsvarende forhåndsinnstilte parametere, som kan tilpasses under svei-seprosedyren.

Tilpasningene blir ikke lagret!

De frie innstillingene 1 – 4 er forhåndsinnstilt i fabrikken og kan programmeres fritt. Parametrene forblir lagret også etter at enheten ble koblet fra.

Sveiseprogram	Nominell PLAST [°C]	Nominell AIR [°C]
Fri innst. 1 – 4	230	260
Prg1 PE-LD	220	260
Prg2 PE-HD	230	260
Prg3 PP	240	260
Prg0 PVC-U	200	300

Det aktuelt innstilte **sveiseprogrammet (17)** vises i arbeidsvinduet.

Alt etter maskin- og programvareversjon, kan visningen av materialene avvike.

Innstilling av ekstruderingsmengden

- Ved å trykke på **Select-tasten (28)**, stilles markøren på posisjonen «SPEED».
- Still inn ekstruderingsverdien (30 til 100 %) via **Up-tasten (29)** eller **Down-tasten (27)**

Innstilling av temperatur for PLAST og AIR

- Ved å trykke på **Select-tasten (28)**, kan markøren stilles på posisjonen «PLAST» eller «AIR».
- Still inn temperaturverdien via **Up-tasten (29)** eller **Down-tasten (27)**

Slå av enheten

- Løsne **låsemekanisme motor (4)** og slipp **På/Av-bryteren motor (2)**.
Fjern sveisematerialet i sveiseskoen, slik at sveiseskoen ikke blir skadet ved neste start.
- Slå av oppvarmingen med **Standby-/ Enter-tasten (26)**
- La enheten kjøle seg ned i ca. 5 min.
- Slå av **hovedbryteren (1)**

Ytterligere innstillinger



Kontrastinnstilling

Ved ugunstige lysforhold og variasjoner i omgivelsestemperaturen kan kontrasten innstilles via **Back-tasten (25)**.

Oppvarming ON/OFF

Ved lengre avbrytelse (Standby) kan oppvarmingen for PLAST og AIR slås av via **Standby-/Enter-tasten (26)**.

Aktivere tastelåsen

1. Meny 
2. Tastelås 
3. Aktivering 

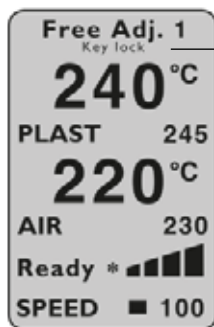

Hvis tastelåsen ble aktivert, vises Tastelås i displayet



Aktivere
tastelåsen

Låsen kan tilbakestilles igjen som vist nedenfor:

Deaktivere tastelåsen

1. Back 
2. Tilbakestill 
3. Utvelging 

Bekreftelsen gjennom Select-tasten må følge umiddelbart etter tilbakestillingen!

Meny navigering

Meny

Meny 

Utvalg  

Utvelging 

Funksjoner

Utvalg  

Utvelging
og tilbake 

Tilbake til
arbeidsvinduet 
Utvalg

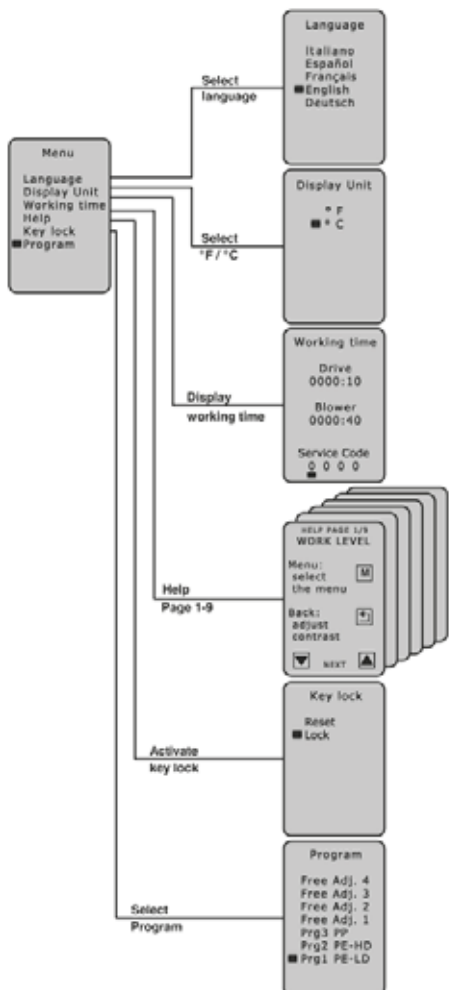

Feilmeldinger

Hvis det oppstår en feil, vises denne i **statusvisningen (30)** (f.eks. **Err04** Motoren er overopphetet).

Visning **ErrXX**

Når det oppstår en feil blir oppvarmingen for AIR og PLAST, så vel som drivmotoren slått av umiddelbart! Dersom dette ikke skjer, må enheten skilles omgående fra strømmettet!

Videre frengangsmåte ved statusvisning motor (30) **ErrXX**

- Notere Errorcoden
- Løsne **låsemekanismen motor (4)** og slipp **På/Av-bryteren motor (2)**.
- Slå av **hovedbryteren (1)**
- Start enheten på nytt mens du overvåker den og pass på, at hånd-ekstruderen ikke blir overopphetet fra en ekstern kilde
- Kunststoffet som er blitt igjen i skruen bør ekstruderes om mulig
- Dersom feilen oppstår igjen under angivelse av Errorcoden, må enheten sendes til servicestedet for kontroll

Følgende feil blir gjenkjent av enheten:

Visning	av type feil
Err01	Overtemperatur av luften, eller defekt temperatursonde
Err02	Overtemperatur av kunststoffmassen, eller defekt temperatursonde
Err04	Overtemperatur i motorviklingen, motoren er overopphetet
Err08	Overtemperatur i varmeelementet AIR, eller svikt av blåsermotoren
Err10	Overtemperatur i elektronikken
Err40	Kortslutning i temperatursonden PLAST

Dersom det oppstår flere feil samtidig, f.eks. **Err02** og **Err04**, vises **Err06**.

Ytterligere kombinasjoner vises med bokstavene A, B, C, D, E og F, f.eks. **Err08** og **Err02** visning **Err0A**

Overtemperaturvern motor

Blir motoren overopphetet gjennom ytre faktorer, eller ved for lav PLAST-temperatur, kobles motoren ut via det interne temperaturvernet (se **Err04**).

Startsperre motor

Drivmotoren er sikret mot automatisk start etter feil, f.eks. overoppheting **Err04**. Visningen «Slå av motoren» vises i **displayet (5)**, mens motoren blir stående i blokkert tilstand. Etter at feilen ble utbedret og motoren er slått av (løsne **låsemekanisme motor (4)** og slipp **På/Av-bryteren (2)**) slukkes visningen «Slå av motoren» i **displayet (5)**. Nå kan arbeidet fortsette.

Veksling av tilbehør



Fare for forbrenning!



Man må kun arbeide med temperaturbestandige hansker.

Skifte av sveiseskoen

Skifte av sveisesko må foretas på driftsvarm enhet.

Demontering

- Slå av den driftsvarme enheten og kople den fra strømtilførselen.
- Fjern **sveiseskoen (8)** med **sveiseskoholderen (34)** fra **ekstruderdyesen (32)** ved å løsne **klemmskruene (35)**
- **Ekstruderdyesen (32)** må rengjøres for rester av sveisemateriale før hvert skifte av sveisesko, og det må sikres at den er fastskrudd.
- Fjern **sveiseskoen (8)** fra **sveiseskoholderen (34)** ved å løsne **låseskruene (33)**

Montering

- Monter en **sveisesko (8)** som er tilpasset sveisesømmen på **sveiseskoholderen (34)** med **låseskruer (33)**
- **Sveiseskoen (8)** og **sveiseskoholderen (34)** må trekkes godt til med **klemmskruene (35)**

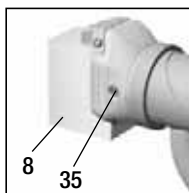
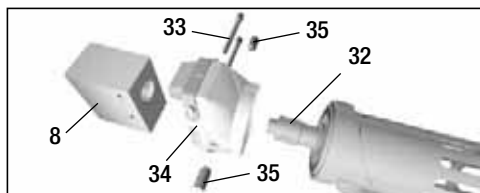

- 8 Sveisesko
- 32 Ekstruderdyse
- 33 Låseskruer
- 34 Sveiseskoholder
- 35 Klemmskruer

Sveiseretning

Ved å løsne **klemmskruene (35)** kan **sveiseskoen (8)** dreies trinnløst i den ønskede sveiseretningen. Deretter må **klemmskruene (35)** trekkes godt til igjen.

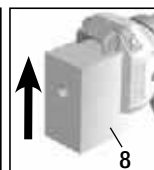
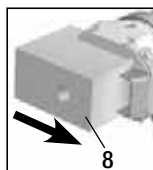
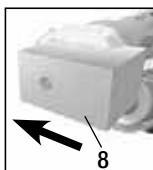

Skifte av varmluftføringen

For å demontere **varmluftføringen (44)** må **sveiseskoen (8)** først fjernes. Etter å ha løst **fikseringsskruen (45)** som er sikret med kontramutter på **rørklemmen (10)** og **klemmskruen (47)** på koplingsstykket til varmluftføringen, kan hele enheten trekkes av. Monteringen skjer i omvendt rekkefølge.

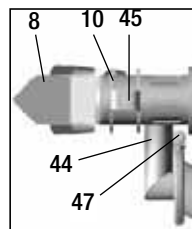

Skifte av forvarmingsdysen

Demontering: Ved forvarmingsdysen, løsne **klemskruen (43)** på **forvarmingsdysen (9)** og trekk **forvarmingsdysen (9)** fra **varmluftføringen (44)**.

Montering: Skyv **forvarmingsdysen (9)** på **varmluftføringen (44)**.
Pass på, at dysen er plassert parallelt.
Trekk til **klemskruen (43)**.

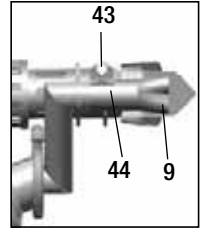

Forvarmingsdyser for enheter med ekstern luftkjøling

Det står tre forskjellige forvarmingsdyser, som tilsvare bredden på **sveisesømmen (9)**, til utvalg. Dyse-nes tverrsnitt er i samsvar med DSV-retningslinjene.



Dyse 1

Sømbredde
opptil 15 mm

Dyse 2

Sømbredde
fra 16 til 20 mm

Dyse 3

Sømbredde
fra 21 til 40 mm

Sveisesko-sortiment

Leister Technologies AG tilbyr passende sveisesko i forskjellige størrelser for alle vanlige sveiseutførelser:

WELDPLAST S2 / WELDPLAST S2-TPO med integrert luftføring

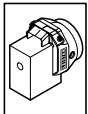

Emne



V-sveis



Kilsveis

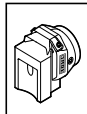

Over-
lappsveis

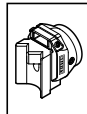

Hjørnesøm
utvendig

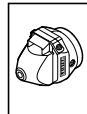

Hjørnesøm
kort

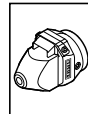

Hjørnesøm
lang



45°

vinkelhode



90°

WELDPLAST S2 / WELDPLAST S2-PVC med ekstern luftføring

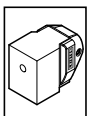

Emne

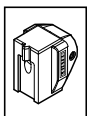

V-sveis

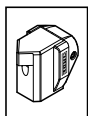

Kilsveis

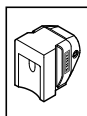

Over-
lappsveis

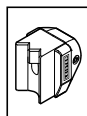

Hjørnesøm
utvendig

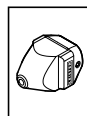

Hjørnesøm
kort

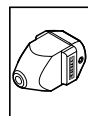

Hjørnesøm
lang

Tilbehør

Det skal kun brukes **tilbehør fra Leister**.

Maskinstativ



Bærbar sveisetrådholder

- Innretningen er konstruert for sveisetrådroller med \varnothing 300 mm
- For å sikre en optimal trådmating, skal sveisetråden føres gjennom det dertil egnede **øyet (41)**

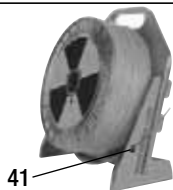

Vedlikehold

- Sjekk **strømledningen (14)** og støpselet kontrolleres for elektriske og mekaniske skader
- Fjern rester av sveisemateriale fra **ekstruderdysen (32)** ved hvert skifte av sveisesko

Service og reparasjon

- Reparasjoner skal kun utføres av autoriserte **Leister-servicesteder**. Disse sikrer en faglig korrekt og pålitelig **reparasjonsservice innen 24 timer**, med originale reservedeler i henhold til koblings skjemaer og reservedelslister.
- Viser servicedisplayet med **servicekoden 1** på WELDPLAST S2 etter at enheten ble slått på, må kullnivået kontrolleres av et autorisert **servicested fra Leister**, og kullbørstene på motoren må eventuelt skiftes ut.
- Visningen kan skjules igjen med **Select-tasten (28)** 
- Man kan fortsette arbeidet med hånd-ekstruderen for en kort tid.
- Dersom kullbørstene ikke blir skiftet ut innen en ganglig tid, kjører motoren til den stopper mekanisk på grunn av manglende kullbørster. På displayet vises ingen feilmelding, men motoren starter ikke igjen.



Garanti

- For dette apparatet gjelder de garantirettigheter som er gitt av den direkte salgsrepresentanten/selgeren fra kjøpsdato. Ved et garantikrav (påvises med faktura eller følgebrev) blir produksjons- eller bearbeidingsfeil utbedret av salgsrepresentanten med ny levering eller reparasjon. Varmeelementer dekkes ikke av garantien.
- Ytterligere garantikrav utelukkes i rammen av ufravelige rettsregler.
- Skader som oppstår på grunn av naturlig slitasje, overbelastning eller ufagmessig behandling dekkes ikke av garantien.
- Det kan ikke fremlegges garantikrav for apparater som er bygget om eller endret av kjøperen.



Instruções de funcionamento (Tradução do manual de instruções original)



Ler atentamente o manual de instruções antes da colocação em funcionamento e guardar para disponibilização.

Leister WELDPLAST S2 / S2-PVC / S2-TPO Extrusora manual

Utilização

Soldadura por extrusão dos seguintes materiais:

WELDPLAST S2 PP / PE-HD / PE-LD
WELDPLAST S2-PVC PP / PE-HD / PE-LD / PVC-U
WELDPLAST S2-TPO PP / PE-HD / PE-LD / TPO

Outros materiais a pedido

Extrusora manual corresponde à norma DVS (Associação Alemã para Tecnologia da Soldadura) 2207-4.

DVS: Associação Alemã para Tecnologia da Soldadura



Aviso



Perigo de vida ao abrir o aparelho, visto que os componentes sob tensão e ligações estão livres. Antes de abrir o aparelho retirar a ficha da tomada. Material electricamente condutor (p.ex. PE-EL) não pode ser soldado.



Perigo de incêndio e explosão na utilização incorrecta da extrusora manual (p.ex. sobreaquecimento de material) especialmente perto de materiais inflamáveis e gases explosivos.



Perigo de queimaduras! Não tocar nas peças metálicas polidas e massa a verter em estado quente. Deixar arrefecer o aparelho. Não direccionar o jacto de ar quente e massa a verter para pessoas e animais.



Ligar o aparelho numa tomada com **condutor de protecção**. Cada interrupção do condutor de protecção dentro ou fora do aparelho é perigosa!

Utilizar apenas extensão com condutor de protecção!



Cuidado



A **tensão nominal** mencionada no aparelho tem de corresponder à tensão de rede. Em caso de falha eléctrica o interruptor principal e accionamento têm de ser desligados (soltar bloqueio).



Interruptor FI na utilização do aparelho em obras é **necessário** para a protecção pessoal.



O aparelho tem de ser operado sob vigilância. O calor pode passar para os materiais inflamáveis, que se encontram fora do campo visual.

O aparelho só pode ser utilizado por técnicos especializados ou sob vigilância. A utilização por crianças é proibida.



Proteger o aparelho de humidade e água.

Conformidade

Leister Technologies AG, Galileo-Strasse 10, CH-6056 Kaegiswil/Suíça que este produto corresponde, na versão por nós colocada no mercado, aos requisitos das seguintes directivas CE.

Directivas:	2006/42 2004/108 (até 19.04.2016), 2014/30 (a partir de 20.04.2016) 2006/95 (até 19.04.2016), 2014/35 (a partir de 20.04.2016) 2011/65
Normas harmonizadas:	EN 12100, EN 55014-1, EN 55014-2, EN 61000-6-2, EN 61000-3-2, EN 61000-3-3, EN 62233, EN 60335-1, EN 60335-2-45, EN 50581

Kaegiswil, 04.01.2016

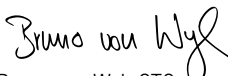
Bruno von Wyl, CTO

Andreas Kathriner, GM

Eliminação



Ferramentas elétricas, acessórios e embalagens devem ser conduzidos para uma reciclagem compatível com o ambiente. **Somente para países da UE:** Não jogue ferramentas elétricas no lixo doméstico!

Dados técnicos

Tensão	V~	230	200
Potência	W	3000	2400
Frequência	Hz	50/60	
Quantidade de ar (20 °C)	l/min	300	
Temperatura do ar	°C	máx. 350	
Temperatura de plastificação	°C	máx. 260	
Extracção (Ø 3 mm)	kg/h	PE 0.6–1.3 PP 0.5–1.2 *PVC-U 0.9–1.7 (valores médios a 50 Hz)	
Extracção (Ø 4 mm)	kg/h	PE 1.0–2.3 PP 0.9–2.0 *PVC-U 1.5–2.7 (valores médios a 50 Hz)	
Fio de soldar	mm	Ø 3 / Ø 4	
Massa C × L × A	mm	450 × 98 × 260 (sem sapata de soldadura)	
Peso	kg	5.8 (sem cabo de ligação à rede)	
Símbolo de conformidade		CE	CE
Símbolo de segurança		Ⓢ	
Classe de protecção I		Ⓜ	Ⓜ

* WELDPLAST S2-PVC

Reservam-se os direitos a alterações técnicas

Descrição do aparelho

Com conduta de ar externa

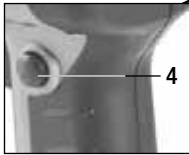
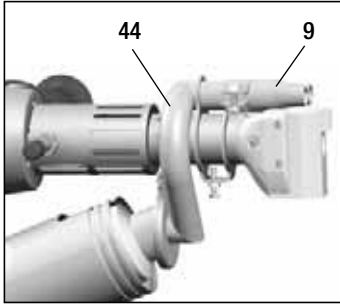

Com conduta de ar integrada

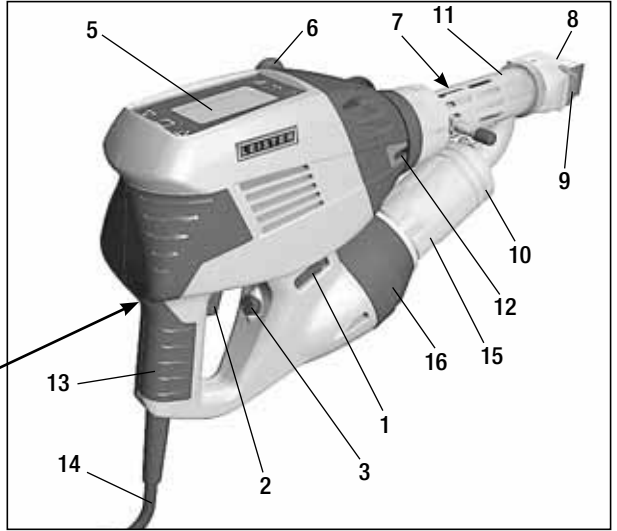

- 1 Interruptor principal
- 2 Interruptor de lig./deslig. do accionamento
- 3 Potenciómetro
- 4 Bloqueio accionamento
- 5 Visor
- 6 Pega
- 7 Aquecimento do revestimento
- 8 Sapata de soldadura
- 9 Injetor de pré-aquecimento

- 10 Aperto do tubo
- 11 Tubo de protecção
- 12 Inserção do fio de soldar
- 13 Pega do aparelho
- 14 Cabo de ligação à rede
- 15 Tubo de protecção com Elemento de aquecimento
- 16 Ventilador de ar quente (sem escova)
- 44 Conduta de ar quente externa

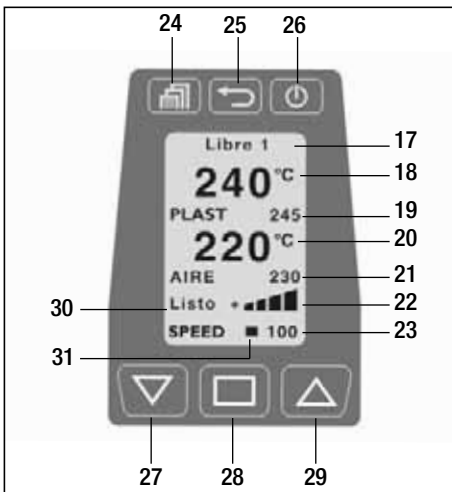

Unidade de utilização

- 17 Programa de soldadura
- 18 Valor real Plast
- 19 Valor nominal Plast
- 20 Valor real Air
- 21 Valor nominal Air
- 22 Barra de indicação accionamento
- 23 Indicação de extracção
- 24 Tecla menu
- 25 Tecla back
- 26 Tecla Standby/ Enter
- 27 Tecla Down
- 28 Tecla Select
- 29 Tecla Up
- 30 Indicação de estado accionamento
- 31 Cursor

Ambiente de trabalho / segurança



A extrusora manual não pode ser utilizada em ambientes susceptíveis a explosão ou a inflamação. Observar uma posição segura durante o trabalho. O cabo de ligação à rede e o fio de soldar têm de ser maneáveis e não podem criar um obstáculo para o utilizador ou terceiros durante o trabalho.



Colocar a extrusora manual em cima de uma base resistente ao fogo! Peças metálicas quentes e jactos de ar quente têm de estar a uma distância deficiente da base e paredes.

Ajuste pega

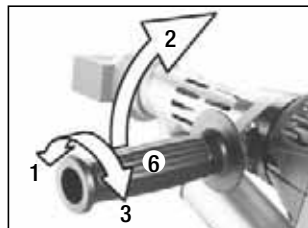

1. Ao rodar a **pega (6)** no sentido contrário dos ponteiros do relógio soltar o aperto
2. Colocar a **pega (6)** na posição de trabalho pretendida
3. Ao rodar a **pega (6)** no sentido dos ponteiros do relógio apertar novamente o aperto

Local de trabalho



Para a colocação em funcionamento e colocação da extrusora manual a Leister oferece uma **base universal para o aparelho**.



Ao interromper os trabalhos de soldadura, o accionamento deve ser desligado com o **interruptor lig/deslig. accionamento (2)**.

Colocar a extrusora manual com a pega respectivamente ajustada e bem apertada em cima de uma base estável e resistente ao fogo conforme a imagem.

Extensão

Ai utilizar extensões prestar atenção ao corte transversal mínimo:

A extensão tem de estar autorizada para o local de aplicação (p.ex. ao ar livre) e tem de estar respectivamente identificado.

Ao utilizar um agregado para a alimentação de energia é válido para a potência nominal: $2 \times$ potência nominal extrusora manual.

Comprimento [m]	Corte transversal mínimo (a 230V~) [mm ²]
até 19	2.5
20 – 50	4.0

Preparação para soldadura

A monitorização da temperatura evita o arranque da extrusora manual em estado frio.

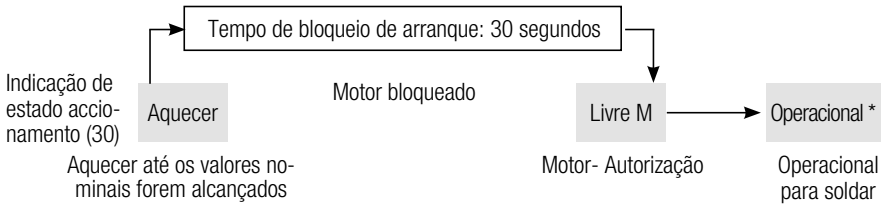

O aparelho aquece directamente após a ligação do **interruptor principal (1)** para as temperaturas nominais ajustadas por último. Quando as temperaturas nominais forem alcançadas, um contador conta na indicação do estado de 30 segundos até zero. Após o decorrer deste processo de iniciação, o aparelho está operacional para ser soldado (estado operacional*). A extrusora manual alcança a sua temperatura de funcionamento após aprox. 4 minutos.

Com uma interrupção breve não é necessário nenhum novo processo de iniciação.

Software e condução pelo menu

A extrusora manual Weldplast S2 está equipada com um software confortável, que facilita o trabalho ao operador. As teclas ficam activas com um leve toque.

	Funções janela de trabalho	Funções selecção do menu
	Seleção do menu	Seleção do menu / retroceder para a janela de trabalho
	Configurar o contraste	Retroceder para a janela de trabalho (alteração não é memorizada!)
	Aquecimento on/off	Seleccionar e retroceder para a janela de trabalho
	Alterar posição do cursor	Seleccionar
	Valor seleccionado [+]	Cursor para cima / valor seleccionado [+]
	Valor seleccionado [-]	Cursor para baixo / valor seleccionado [-]

Janela de iniciação

No visor, após a ligação da extrusora manual no **interruptor principal (1)**, é visualizado o nome do aparelho e a versão de software actual por 3 segundos.



Janela de trabalho

A janela de trabalho apresenta os parâmetros actuais configurados.



Configuração dos parâmetros na janela de trabalho

O **cursor (31)** indica, qual o parâmetro que deve ser configurado. Após a ligação o cursor encontra-se na posição «SPEED». Com a **tecla Select (28)** pode ser activado «AIR» ou «PLAST» e com a **tecla Up (29)** ou a **tecla Down (27)** podem ser alterados os seus valores.

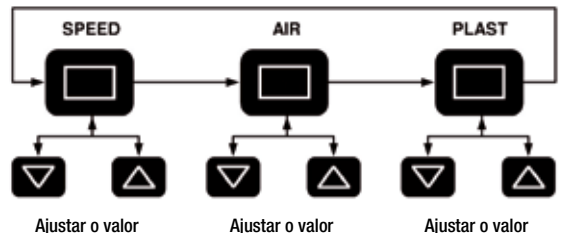

Preparação para soldadura

Configurar a quantidade de extracção

Devido à forma da costura, a quantidade de extracção e período de pré-aquecimento podem ser sintonizados.

- Pré-configuração no visor
 - Premindo a **tecla Select (28)** colocar o cursor na posição «SPEED».
 - Determinar o valor de extracção máximo (30 a 100 %) através da **tecla Up (29)** ou **tecla Down (27)** (é apresentado através da **barra de indicação accionamento (22)**)
- Configuração pormenorizada durante o processo de soldadura
 - A partir do valor de extracção configurado (p.ex. 85%) a quantidade de extracção pode ser reduzida para o mínimo rodando o **potenciômetro (3)**.

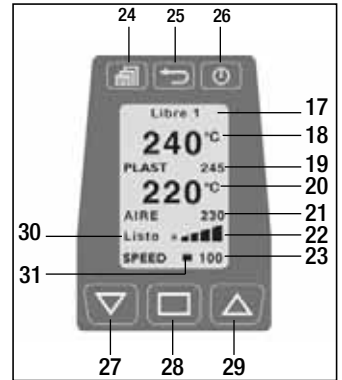

A quantidade de extracção depende da espessura do fio de soldar utilizado. Se a extracção com a indicação de extracção «30» e posição do potenciômetro «mínimo» for muito grande, tem de se trocar para a próxima espessura do fio de soldar.

Configurar as temperaturas PLAST e AIR

- Ao premir a **tecla Select (28)** colocar o cursor na posição «PLAST» ou «AIR»
- Configurar o valor de temperatura através da **tecla Up (29)** ou **tecla Down (27)**

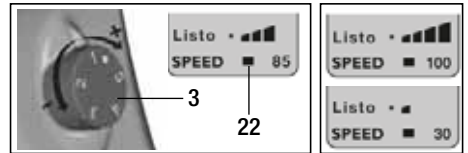

Monitorização dos parâmetros de soldadura

Os valores nominais e reais das temperaturas AIR e PLAST são constantemente monitorizados. Se um valor real se desviar do respectivo valor nominal (valor está fora da banda de tolerância), isto é sinalizado na **indicação do estado (30)** através de uma mudança de estado. Caso necessário, o motor de accionamento é bloqueado temporariamente, até que os parâmetros de soldadura estejam de novo na tolerância indicado. As possíveis indicações de estado e bandas de tolerância são visíveis no seguinte gráfico ou tabela.

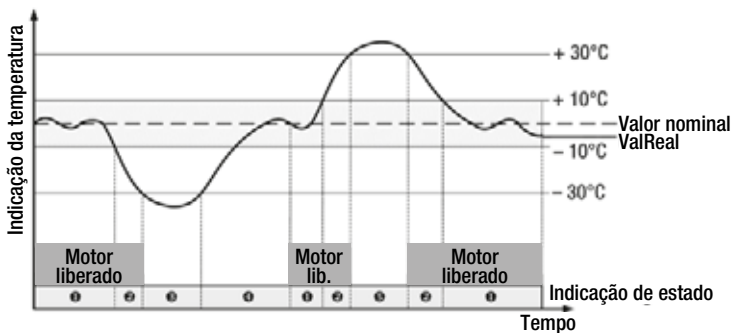

N.º	Indicação do estado	Características estado
1	Operacional*	Operacional para soldar
2	Livre M	Desvio dos parâmetros de soldadura (plástico) > 10°C
3	Aquecer	Desvio dos parâmetros de soldadura (plástico) > - 30°C, motor de accionamento bloqueado
4	30s	Tempo de bloqueio de arranque de 30 seg., motor de accionamento bloqueado
5	muito quente	Desvio dos parâmetros de soldadura > + 30°C, motor de accionamento bloqueado

Início do processo de soldadura

- Conforme necessário montar a respectiva **sapata de soldadura (8)**
- Ajustar o **potenciômetro (3)** para o máx.
- Quando a temperatura de funcionamento for atingida (estado operacional*), pode-se iniciar com a soldadura
- Accionar **interruptor lig./deslig. accionamento (2)**
- Introduzir o fio de soldar com o diâmetro 3 ou 4 mm na **inserção do fio de soldar (12)**
- O fio de soldar é inserido automaticamente pela **inserção do fio de soldar (12)**. A alimentação do fio tem de ocorrer sem resistência



ATENÇÃO!

Operar o aparelho sempre com fio de soldar, mas nunca inserir simultaneamente em ambas as inserções do fio de soldar.

- Interromper transporte da massa com o **interruptor lig./deslig. accionamento (2)**
- Direccionar o **injector de pré-aquecimento (9)** para a zona de soldadura
- Pré-aquecer a zona de soldadura com movimentos pendulares
- Colocar o aparelho na zona de soldadura preparada e accionar novamente o **interruptor lig./deslig. accionamento (2)**
- Executar teste de soldadura conforme manual de soldadura do fabricante do material e normas nacionais ou directivas
- Verificar teste de soldadura
- Adaptar a configuração da temperatura e quantidade de extracção conforme a necessidade
- Num processo de soldadura mais logo o **interruptor lig./ deslig. accionamento (2)** pode ser mantido em funcionamento permanente com o **bloqueio accionamento (4)**

WELDPLAST S2 - PVC

- PVC-U apenas pode ser processado no menu PVC-U. ATENÇÃO: Utilizar apenas PVC-U (não PVC-C!)
- Para prevenir a corrosão recomenda-se, que o aparelho seja abastecido com HD-PE quando não é utilizado por um longo período (a partir de 2 dias).

Parâmetros de soldadura

Menu	
Seleccionar programa	
Seleccção	 
Entrada	

Programa: A indicação dos materiais pode divergir de acordo com a versão do aparelho e do software.

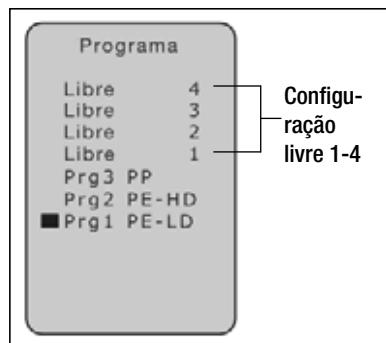

Os programas 1 – 3 estão equipados com parâmetros pré-configurados, que podem ser ajustados durante o processo de soldadura.

Os ajustes não são memorizados!

As configurações livres 1 – 4 estão configuradas de fábrica e podem ser livremente programadas. Os parâmetros continuam memorizados mesmo depois de desligar o aparelho.

Programa de soldadura	Nominal PLAST [°C]	Nominal AIR [°C]
Entr. livres 1 – 4	230	260
Prg1 PE-LD	220	260
Prg2 PE-HD	230	260
Prg3 PP	240	260
Prg0 PVC-U	200	300

O programa de soldadura ajustado actualmente (17) é visível na janela de trabalho.

A indicação dos materiais pode divergir de acordo com a versão do aparelho e do software.

Configurar a quantidade de extracção

- Premindo a **tecla Select (28)** colocar o cursor na posição «SPEED».
- Configurar o valor de extracção (30 a 100%) através da **tecla Up (29)** ou **tecla Down (27)**

Configurar a temperatura PLAST e AIR

- Ao premir a **tecla Select (28)** colocar o cursor na posição «PLAST» ou «AIR»
- Configurar o valor de temperatura através da **tecla Up (29)** ou **tecla Down (27)** einstellen

Desligar o aparelho

- Soltar o **bloqueio accionamento (4)** e **soltar o interruptor lig./deslig. accionamento (2)**.
Remover o material de soldadura na sapata de soldadura, para que no próximo arranque a sapata de soldadura não seja danificada
- Desligar os aquecimentos com a **tecla Standby/ Enter (26)**
- Deixar arrefecer o aparelho aprox. 5 min.
- Desligar **interruptor principal (1)**

Outras definições



Configuração do contraste

Em caso de condições de iluminação desfavoráveis e oscilações de temperatura ambiente o contraste pode ser definido com a **tecla Back (25)**.

Aquecimento ON/OFF

Numa interrupção prolongada (Standby) o aquecimento para PLAST e AIR pode ser desligado com a **tecla Standby-/Enter (26)**.

Activar bloqueio das teclas

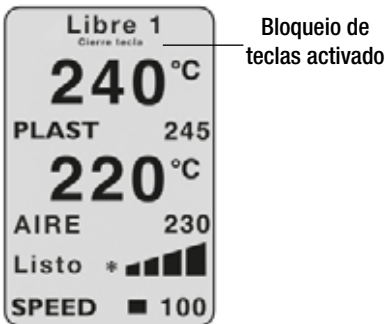

1. Menu 
2. Bloqueio das teclas 
3. Activar 

Se o bloqueio das teclas for activado, surge no visor o **bloqueio de teclas**



O bloqueio pode ser reposto da seguinte forma:

Desactivar bloqueio das teclas

1. Voltar 
2. Repor 
3. Seleccionar 

A confirmação pela tecla Select tem de ocorrer imediatamente após a recolocação!

Operação do menu

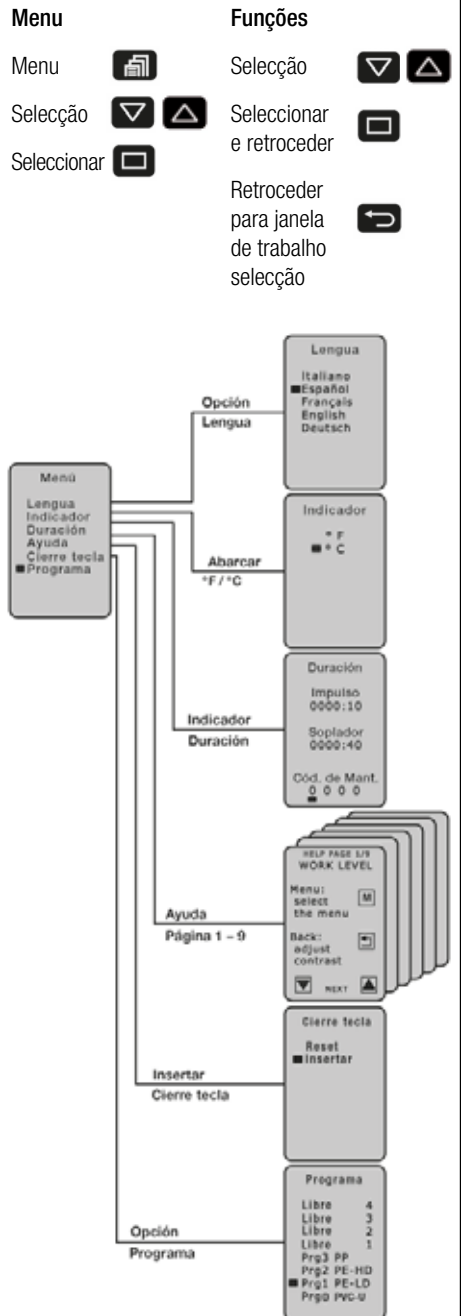

Mensagens de erro

Se ocorrer um erro, este é apresentado na indicação do estado (30) (p.ex. **Err04** motor está sobreaquecido).

Indicação **ErrXX**

Ao ocorrer um erro desligar os aquecimentos para AIR e PLAST, assim como, o motor de accionamento!
Se isto não acontecer, o aparelho deve ser desligado da rede imediatamente!

Procedimento seguinte na indicação do estado accionamento (30) **ErrXX**

- Anotar código de erro
- Soltar o **bloqueio accionamento (4)** e soltar o **interruptor lig./deslig. accionamento (2)**.
- Desligar **interruptor principal (1)**
- Colocar novamente em funcionamento o aparelho de forma monitorizada e prestar atenção, que a extrusora manual não seja aquecida por fora
- Excluir, se possível, o restante plástico na rosca
- Se o erro ocorrer novamente, o aparelho deve ser enviado com a indicação do código de erro para controlo ao local de reparação

São detectados os seguintes erros pelo aparelho:

Indicação	tipo de erro
Err01	Temperatura excessiva do ar ou sonda térmica defeituosa
Err02	Temperatura excessiva da massa de plástico ou sonda térmica defeituosa
Err04	Temperatura excessiva no desenvolvimento do motor, motor está sobreaquecido
Err08	Temperatura excessiva do elemento de aquecimento AIR ou falha do motor do ventilador
Err10	Temperatura excessiva do sistema electrónico
Err40	Curto-circuito da sonda térmica PLAST

Se ocorrer vários erros simultaneamente, p.ex. **Err02** e **Err04**, é apresentado **Err06**.

Outras combinações são apresentadas com as letras A, B, C, D, E e F, p.ex. **Err08** e **Err02** indicação **Err0A**.

Protecção sobreaquecimento accionamento

Se o accionamento for sobreaquecido por influências exteriores ou com a temperatura PLAST muito baixa, a protecção da temperatura interna desliga o accionamento (ver **Err04**).

Protecção de arranque accionamento

O motor de accionamento está assegurado contra o arranque autónomo após erros, p.ex. sobreaquecimento **Err04**. Surge no **visor (5)** a indicação «desligar o accionamento», enquanto o motor de accionamento se mantém em estado bloqueado. Depois da resolução do erro e desconexão do accionamento (soltar **bloqueio accionamento (4)** e soltar o **interruptor lig./deslig. accionamento (2)**) apaga-se no **visor (5)** a indicação «desligar accionamento». Pode-se continuar a trabalhar.

Troca de acessórios



Perigo de queimaduras!



Trabalhar apenas com luvas resistentes a temperaturas.

Substituição da sapata de soldadura

A substituição da sapata de soldadura tem de ser efectuada no aparelho quente.

Desmontagem

- Desligar o aparelho quente e retirar da rede eléctrica
- Remover a **sapata de soldadura (8)** com o **suporte da sapata de soldadura (34)** soltando os parafusos de **aperto (35)** do **injector da extrusora (32)**
- Limpar o **injector da extrusora (32)** de resíduos de soldadura em cada substituição da sapata de soldadura e certificar, que esteja fixo
- Remover a **sapata de soldadura (8)** soltando os **parafusos de fixação (33)** do **suporte da sapata de soldadura (34)**

Montagem

- Montar uma sapata de soldadura adaptada à **costura de soldadura (8)** no **suporte da sapata de soldadura (34)** com **parafusos de fixação (33)**
- A **sapata de soldadura (8)** e **suporte da sapata de soldadura (34)** têm de ser bem apertados com os **parafusos de aperto (35)**

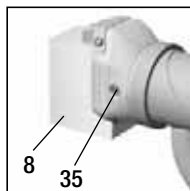
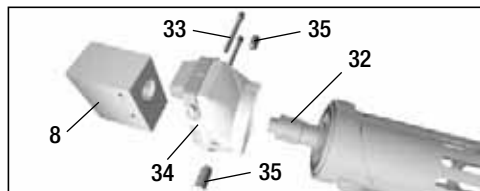

- 8 Sapata de soldadura
- 32 Injector de extrusão
- 33 Parafuso de fixação
- 34 Suporte da sapata de soldadura
- 35 Parafuso de aperto

Direcção de soldadura

Ao soltar os **parafusos de aperto (35)** a **sapata de soldadura (8)** pode ser rodada sem níveis para a direcção de soldadura pretendida. Os **parafusos de aperto (35)** têm de ser reapertados depois.

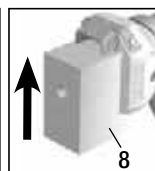
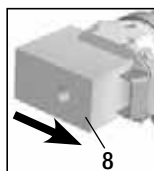
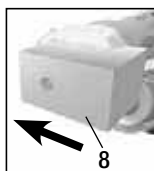

Substituição da conduta de ar quente

Para a desmontagem da **conduta do ar quente (44)** é retirado primeiramente a **sapata de soldadura (8)**. Depois de desapertar o **parafuso de fixação (45)** no **aperto do tubo (10)** e no **parafuso de aperto (47)** no conector da conduta do ar quente toda a unidade pode ser retirada.

Montagem por ordem inversa.

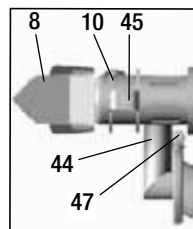

Substituição do injector de pré-aquecimento

Desmontagem: No injector de pré-aquecimento, soltar o **injector de pré-aquecimento (9)** **parafuso de aperto (43)** e retirar o **injector de pré-aquecimento (9)** da **conduta de ar quente (44)**.

Montagem: Deslocar o **injector de pré-aquecimento (9)** para **conduta de ar quente (44)**. Ter em atenção à disposição paralela relativamente à base do injector.
Apertar **parafuso de aperto (43)**.

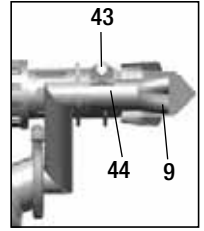

Injectores de pré-aquecimento para aparelhos com conduta de ar externa

Estão disponíveis três **injectores de pré-aquecimento (9)** diferentes que correspondem à largura da costura de soldadura. Os cortes transversais dos injectores correspondem às directivas DVS.



Gama de sapatas de soldadura

Leister Technologies AG oferece para todas as formas de costuras utilizáveis respectivas sapatas de soldadura em diversos tamanhos:

WELDPLAST S2 / WELDPLAST S2-TPO

Com conduta de ar integrada

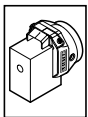

Peça em bruto

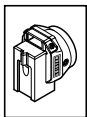

Costura V



Costura côncava

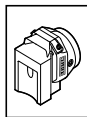

Costura sobreposta

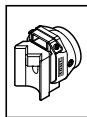

Costura de canto externa

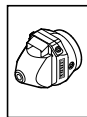

Costura de canto curta



Costura de canto longa

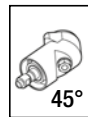

45°

Cabeçote angular

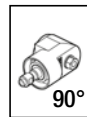

90°

WELDPLAST S2 / WELDPLAST S2-PVC

Com conduta de ar externa

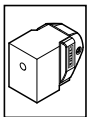

Peça em bruto

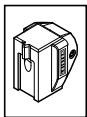

Costura V

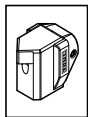

Costura côncava

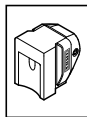

Costura sobreposta

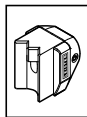

Costura de canto externa

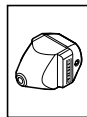

Costura de canto curta

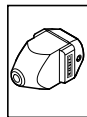

Costura de canto longa

Acessórios

Apenas podem ser **utilizados acessórios da Leister.**

Base para o aparelho



Dispositivo de desenrolamento do fio móvel

- O dispositivo está equipado para rolos de fio de soldar com \varnothing 300 mm
- Para garantir um desenrolar do fio ideal, o fio de soldar deve ser inserido pelo olhal destinado para isso (41)

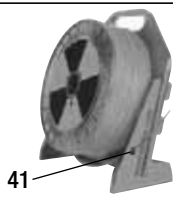

41

Manutenção

- Verificar o **cabo de ligação à rede (14)** e a ficha quanto a danos eléctricos e mecânicos.
- Libertar o **injector de extrusão (32)**, em cada substituição da sapata de soldadura, de resíduos de soldadura

Assistência e reparação

- As reparações devem ser efectuadas por **pontos de assistência Leister autorizados**. Estes garantem **dentro de 24 horas um serviço de reparação** especializado e fiável com peças de substituição originais de acordo com os esquemas eléctricos e listas de peças de substituição.
- Se ocorrer na WELDPLAST S2 após a ligação do aparelho, a indicação de assistência com o **código de assistência 1**, o estado do carvão deve ser controlado pelo **ponto de assistência autorizado** e, se necessário, substituir as escovas de carvão.
- A indicação pode ser ocultada novamente com a **tecla (28)**. 
- Com a extrusora manual pode-se continuar a trabalhar por breves instantes.
- Se as escovas de carvão não forem substituídas no prazo útil, o accionamento funciona até alcançar o stop do carvão mecânico. Na indicação não surge nenhuma mensagem de erro, mas o accionamento não arranca novamente.



Garantia legal

- Para este aparelho são válidos os direitos de garantia e de garantia adicional assegurados diretamente pelo distribuidor/vendedor, a partir da data de compra. No caso de uma reivindicação de garantia ou garantia adicional (comprovação através de nota fiscal ou nota de entrega) as falhas do fabricante ou de montagem do distribuidor são corrigidas com o fornecimento de peças de reposição ou reparo. As resistências estão excluídas da garantia ou garantia adicional.
- Outras pretensões de garantia ou garantia adicional ficam excluídas, no âmbito do direito imperativo.
- Danos causados por desgaste natural, sobrecarga ou manuseio incorreto estão excluídos da garantia.
- Não existe direito a reclamação ao abrigo da garantia ou garantia adicional em casos em que os aparelhos tenham sido reformados ou modificados pelo comprador.



Läs noga igenom bruksanvisningen innan automaten används för första gången och tag vara på den i fortsättningen.

Leister WELDPLAST S2 / S2-PVC / S2-TPO Handextruder

Användning

Extrusionssvetsning av följande material:

WELDPLAST S2 PP / PE-HD / PE-LD
WELDPLAST S2-PVC PP / PE-HD / PE-LD / PVC-U
WELDPLAST S2-TPO PP / PE-HD / PE-LD / TPO
Fler material på begäran

Handextruder motsvarar DVS-normen 2207-4.

DVS: Deutscher Verband für Schweisstechnik (den tyska sammanslutningen för svets teknik)



Varning



Livsfara vid öppning av apparaten i och med att spänningsförande komponenter och anslutningar friläggs. Dra alltid ut maskinens nätkabel från vägguttaget. Elektriskt ledande material (t.ex. PE-EL) får inte svetsas.



Brand- och explosionsrisk vid felaktig användning av handextrudern (t.ex. överhettning av material) särskilt i närheten av brännbara material och explosiva gaser



Risk för brännskador! Berör inte blanka metalldelar och utträngande massor i hett tillstånd. Låt maskinen svalna. Rikta aldrig den heta värmestrålen och utträngande massor mot personer eller djur.



Anslut maskinen till ett **eluttag med skyddsledare**. Varje avbrott av skyddsledaren inuti och utanför apparaten är farligt!

Använd endast förlängningskablar med skyddsledare!



Obs



Den märkspänning som anges på maskinen måste stämma överens med befintlig nätspänning. Vid strömavbrott måste huvudbrytaren och drivningen slås av (lossa låsningen).



En **FI-brytare** är absolut nödvändig för personskydd vid användning av maskinen på byggsplatser.



Maskinen får endast användas under tillsyn.

Värme kan nå brännbara material som befinner sig utom synhåll. Apparaten får endast användas av utbildad fackpersonal eller under deras tillsyn. Det är förbjudet för barn att använda maskinen.



Skydda maskinen mot fuktighet.

Överensstämmelse

Leister Technologies AG, Galileo-Strasse 10, CH-6056 Kaegiswil/Schweiz försäkrar att denna produkt i det utförande vi har levererat produkten överensstämmer med kraven i följande EU-direktiv.

Direktiv: 2006/42
2004/108 (t.o.m. 19.04.2016), 2014/30 (fr.o.m. 20.04.2016)
2006/95 (t.o.m. 19.04.2016), 2014/35 (fr.o.m. 20.04.2016)
2011/65

Harmoniserande normer: EN 12100, EN 55014-1, EN 55014-2, EN 61000-6-2, EN 61000-3-2,
EN 61000-3-3, EN 62233, EN 60335-1, EN 60335-2-45, EN 50581

Kaegiswil, 04.01.2016

Bruno von Wyl
Bruno von Wyl, CTO

Kathrine G.
Andreas Kathriner, GM

Avfallshantering



Eldrivna verktyg, tillbehör och förpackningar ska lämnas in för återvinning. **Endast i EU:** Släng inte eldrivna verktyg som vanligt avfall!

Tekniska data

Spänning	V~	230	200
Effekt	W	3000	2400
Frekvens	Hz	50/60	
Luftmängd (20 °C)	l/min	300	
Lufttemperatur	°C	max. 350	
Plastificeringstemperatur	°C	max. 260	
Utstötning (Ø 3 mm)	kg/h	PE 0.6–1.3 PP 0.5–1.2 *PVC-U 0.9–1.7 (medelvärde vid 50 Hz)	
Utstötning (Ø 4 mm)	kg/h	PE 1.0–2.3 PP 0.9–2.0 *PVC-U 1.5–2.7 (medelvärde vid 50 Hz)	
Svetstråd	mm	Ø 3 / Ø 4	
Mått L x B x H	mm	450 x 98 x 260 (utan svetssko)	
Vikt	kg	5.8 (utan nätslutningsledning)	
Konformitetsmärkning		CE	CE
Säkerhetsmärkning		Ⓢ	
Skyddsklass I		⊕	⊕

* WELDPLAST S2-PVC

Tekniska ändringar förbehållna

Maskinbeskrivning

Med extern luftstyrning

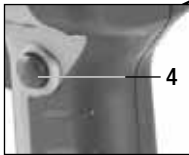
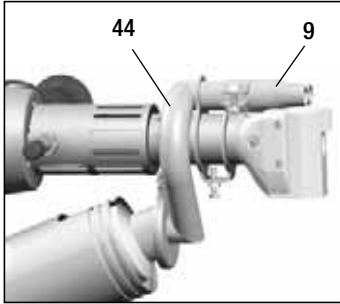

Med integrerad luftstyrning

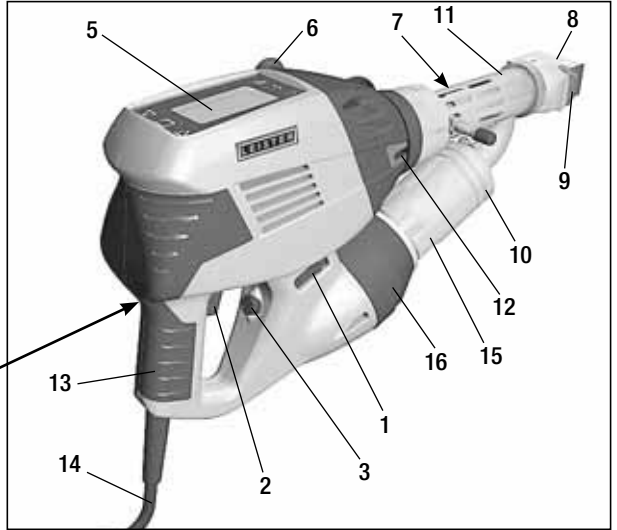

- 1 Huvudbrytare
- 2 Till-/frånbrytare drivning
- 3 Potentiometer
- 4 Låsning drivning
- 5 Display
- 6 Handtag
- 7 Mantelvärmes
- 8 Svtessko
- 9 Fövärmningsmunstycke

- 10 Rörklämma
- 11 Skyddsror
- 12 Införing svetstråd
- 13 Apparathandtag
- 14 Nätanslutningsledning
- 15 Värmeelement med Skyddsror
- 16 Varmluftsflikt (borstlös)
- 44 Extern varmluftstyrning

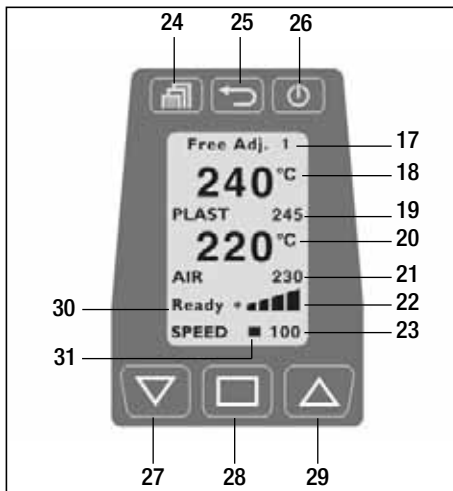

Manöverenheten

- 17 Svetsprogram
- 18 Ärvärde plastificeringstemperatur
- 19 Börvärde plastificeringstemperatur
- 20 Ärvärde lufttemperatur
- 21 Börvärde lufttemperatur
- 22 Visningsstapel drivning
- 23 Utstötningvisning
- 24 Menyknapp
- 25 Bakåtknapp
- 26 Standby-/Enter-knapp
- 27 Down-knapp
- 28 Select-knapp
- 29 Up-knapp
- 30 Statusvisning drivning
- 31 Markör

Arbetsmiljö / säkerhet



Handextrudern får inte användas i miljöer med explosionsrisk resp. risk för antändning. Se till att du står säkert under arbetet. Nätanslutningsledningen och svetstråden måste vara fritt rörliga och får inte hindra användaren eller en tredje person under arbetet.



Placera handextrudern på ett brandbeständigt underlag! Heta metalldelar och varmluftsstrålen måste ha ett tillräckligt avstånd till underlag och väggar.

Inställning handtag

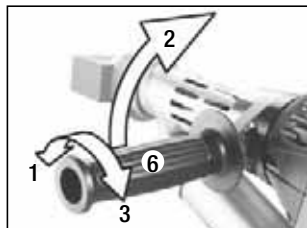

1. Lossa fastspänningen genom att vrida **handtaget (6)** moturs
2. För **handtaget (6)** till önskad arbetsposition
3. Dra åt fastspänningen igen genom att vrida **handtaget (6)** moturs

Arbetsplats



Leister har en universell apparatförvaringsplats för förvaring och idrifttagning av handextrudern.



Vid avbrott i svetsarbetena ska drivningen slås av med **till-/frånbrytaren (2)**.
Ställ handextrudern på ett stabilt, brandbeständigt underlag med lämpligt inställt och fast åtdraget handtag enligt bilden.

Förlängningskabel

Var uppmärksam på minimitvärsnittet vid användning av förlängningskablar:

Förlängningskabeln måste vara korrekt märkt och godkänd för användning i arbetsområdet (t.ex. utomhus).

Vid användning av ett aggregat för energiförsörjning gäller följande för dess märkeffekt: $2 \times$ handextruderns märkeffekt.

Längd [m]	Minimitvärsnitt (vid 230V~) [mm ²]
Upp till 19	2.5
20 – 50	4.0

Förberedelse för svetsning

Temperaturövervakningen förhindrar att handextrudern startar i kallt tillstånd.

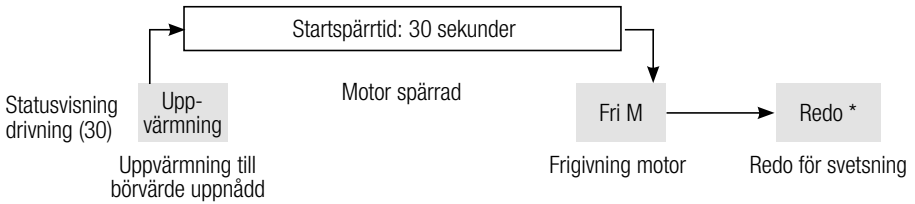

Apparaten värms upp till den senast inställda börtemperaturen direkt när **huvudbrytaren (1)** har slagits på. Om börtemperaturerna har uppnåtts räknar en räknare i statusvisningen från 30 sekunder tillbaka till noll. När detta startförlopp har förflutit är apparaten redo för svetsning (status redo*). Handextrudern uppnår sin drifttemperatur efter cirka 4 minuter.

Vid ett kortvarigt strömavbrott bortfaller ett nytt startförlopp.

Programvara och menystyrning

Handextrudern Weldplast S2 är utrustad med en komfortabel operatörsprogramvara som underlättar arbetet för användaren. Knapparna utlöses genom att man berör dem lätt.

	Arbetsfönstrets funktioner	Funktioner menyval
	Menyval	Menyval/tillbaka till arbetsfönstret
	Ställa in kontrast	Tillbaka till arbetsfönstret (Ändringen sparas inte!)
	Uppvärmning on/off	Selektering och tillbaka till arbetsfönstret
	Ändra markörposition	Selektering
	Selekterat värde [+]	Markör uppåt/selekterat värde [+]
	Selekterat värde [-]	Markör neråt/selekterat värde [-]

Startfönster

På displayen visas apparatens namn och den aktuella programvarversionen under 3 sekunder efter tillkopplingen av handextrudern med **huvudbrytaren (1)**.



Arbetsfönster

Arbetsfönstret visar de för tillfället inställda parametrarna.



Inställning av parametrarna i arbetsfönstret

Markören (31) visar vilken parameter som kan ställas in. Efter tillkopplingen är markören på positionen «SPEED». Med **Select-knappen (28)** kan «AIR» eller «PLAST» väljas och med **Up-knappen (29)** eller **Down-knappen (27)** kan deras värden ändras.

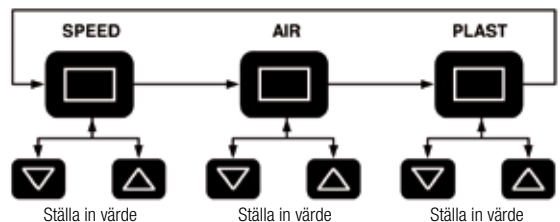

Förberedelse för svetsning

Inställning av utstötningens mängden

På grund av fogformen kan utstötningens mängden och förvärmningstiden avstämmas mot varandra.

- Förinställning på displayen
 - Ställ markören på positionen «SPEED» genom att trycka på **Select-knappen (28)**.
 - Välj det maximala utstötningensvärdet (30 till 100 %) via **Up-knappen (29)** eller **Down-knappen (27)** (illustreras via **visningsstapeln Drivning (22)**)
- Fininställning under svetsningen
 - Utstötningens mängden kan reduceras till ett minimum från det maximalt inställda utstötningensvärdet (t.ex. 85 %) genom att man vrider på potentiometern.

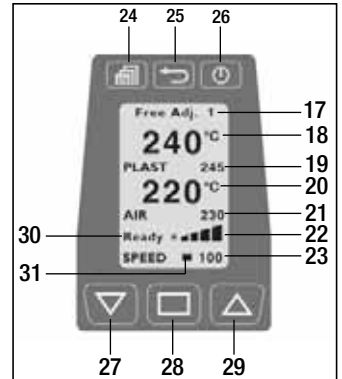

Utsötningens mängden beror på den svetstrådstocklek som används. Om utstötningen är för stor med utstötningensvisningen «30» och potentiometerinställningen «Minimum» är det nödvändigt att byta till närmaste mindre svetstrådstocklek.

Inställning av plastificerings- och lufttemperaturen

- Ställ markören på positionen «PLAST» resp. «AIR» genom att trycka på **Select-knappen (28)**.
- Ställ in temperaturvärdet via **Up-knappen (29)** eller **Down-knappen (27)**.

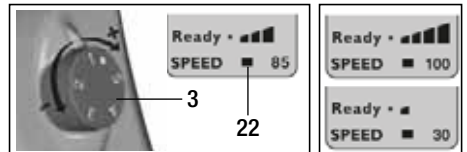

Exempel:

Övervakning av svetsparametrarna

Bör- och ärvärdena för (Air) luft- och (PLAST) plastificeringstemperaturerna övervakas ständigt. Om ett ärvärde avviker från motsvarande börvärde (värdet är utanför toleransbandet) signaleras detta på **statusvisningen (30)** genom ett statusbyte. Vid behov spärras drivmotorn temporärt tills svetsparametrarna ligger i det angivna toleransbandet igen. De möjliga statusvisningarna och toleransbanden framgår av följande diagram resp. tabell.

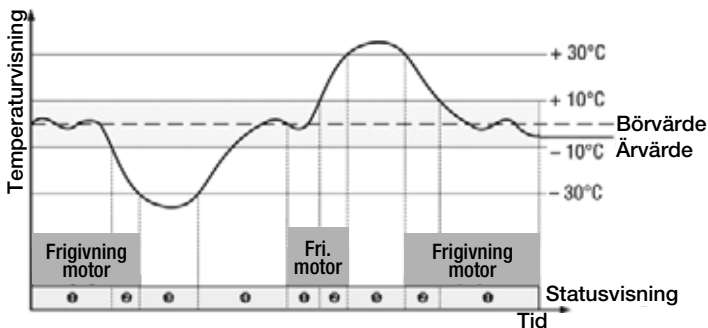

	Statusvisning	Status - egenskaper
①	Redo*	Redo för svetsning
②	Fri M	Avvikelse av svetsparametrarna (plast) > 10 °C
③	Uppvärmning	Avvikelse av svetsparametrarna (plast) > -30 °C, drivmotorn spärrad
④	30s	Startspärrtid på 30 sek., drivmotorn spärrad
⑤	För varm	Avvikelse av svetsparametrarna > +30 °C, drivmotorn spärrad

Start av svetsningen

- Montera en lämplig **svetssko (8)** efter behov.
- Ställ **potentiometern (3)** på max.
- När drifttemperaturen har uppnåtts (status Redo*) kan svetsningen påbörjas.
- Manövrera **till-/frånbrytare drivning (2)**.
- För in svetstråd med diametern 3 eller 4 i **svetstrådsinföringen (12)**.
- Svetstråden dras in automatiskt genom **svetstrådsinföringen (12)**. Trådmatningen måste ske utan motstånd.



OBSERVERA!





Driv alltid apparaten med svetstråd men för aldrig in svetstråd i båda svetstrådsinföringarna samtidigt.

- Avbryt **till-/frånbrytare drivning (2)**.
- Rikta **förvärmingsmunstycket (9)** mot svetszonen.
- Förvärm svetszonen med pendlande rörelser.
- Placera apparaten på den förberedda svetszonen och aktivera **till-/frånbrytare drivning (2)**.
- Utför testsvetsning enligt svetsanvisning från materialets tillverkare och enligt nationella normer och riktlinjer.
- Kontrollera testsvetsningen.
- Anpassa temperaturinställningen och utstötningmängden vid behov.
- Vid en längre svetsning kan **till-/frånbrytare drivning (2)** stoppas i kontinuerlig drift med hjälp av **låsning drivning (4)**.

WELDPLAST S2 - PVC

- PVC-U får endast förberedas på menyn PVC-U. OBS! Använd endast PVC-U (inte PVC-C!)
- För att förebygga korrosion är det lämpligt att fylla apparaten med HD-PE (fr.o.m. 2 dagar) om den inte används under en längre tid.

Svetsparametrar

Meny	
Selektera program	
Val	 
Inmatning	

Program: Visningen av materialen kan avvika beroende på apparat- och programvaruversion.

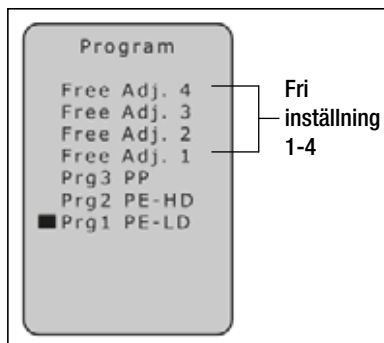

Program 1–3 är utrustade med lämpliga förinställda parametrar som kan anpassas under svetsningen. Anpassningarna sparas inte!

De fria inställningarna 1 – 4 är förinställda i från fabriken och kan programmeras fritt. Parametrarna sparas även när apparaten har stängts av.

Svetsprogram	Bör PLAST [°C]	Bör AIR [°C]
Fri tillk. 1 – 4	230	260
Prg 1 PE-LD	220	260
Prg 2 PE-HD	230	260
Prg 3 PP	240	260
Prg 0 PVC-U	200	300

Det för tillfället inställda **svetsprogrammet (17)** syns i arbetsfönstret. Visningen av materialen kan avvika beroende på apparat- och programvaruversion.

Inställning av utstötningmängden

- Ställ markören på positionen «SPEED» genom att trycka på **Select-knappen (28)**.
- Ställ in utstötningvärdet (30 till 100 %) via **Up-knappen (29)** eller **Down-knappen (27)**.

Inställning av plastificerings- och lufttemperatur

- Ställ markören på positionen «PLAST» resp. «AIR» genom att trycka på **Select-knappen (28)**.
- Ställ in temperaturvärdet via **Up-knappen (29)** eller **Down-knappen (27)**.

Frånkoppling av apparaten

- Lossa **låsning drivning (4)** och släpp **till-/frånbrytare drivning (2)**.
Ta bort svetsmaterialet så att svetseskön inte skadas vid nästa start.
- Stäng av uppvärmningarna med **Standby-/ Enter-knappen (26)**.
- Låt apparaten svalna cirka 5 minuter.
- Stäng av **huvudströmbrytaren (1)**.

Fler inställningar



Kontrastinställning

Vid ogynnsamma ljusförhållanden och fluktuationer i omgivningstemperaturen kan kontrasten ställas in via **Back-knappen (25)**.

Uppvärmning on/off

Vid längre avbrott (standby) kan uppvärmningen för PLAST och AIR stängas av via **Standby-/Enter-knappen (26)**.

Aktivera knappspärr

1. Meny 
2. Knappspärr 
3. Aktivering 

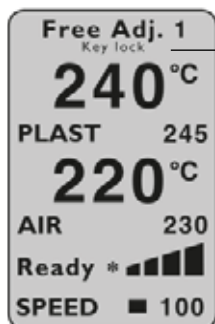

Om knappspärren har aktiverats visas **Knappspärr** på displayen.



Knappspärr
aktiverad

Spärren kan återställas igen på följande sätt:

Deaktivera knappspärr

1. Back 
2. Återställning 
3. Selektion 

Bekräftelsen med Select-knappen måste göras omedelbart efter återställningen!

Menystyrning

Meny

Meny 

Val  

Selektion 

Funktioner

Val  

Selektion
och tillbaka 

till
arbetsfönstret 
Val

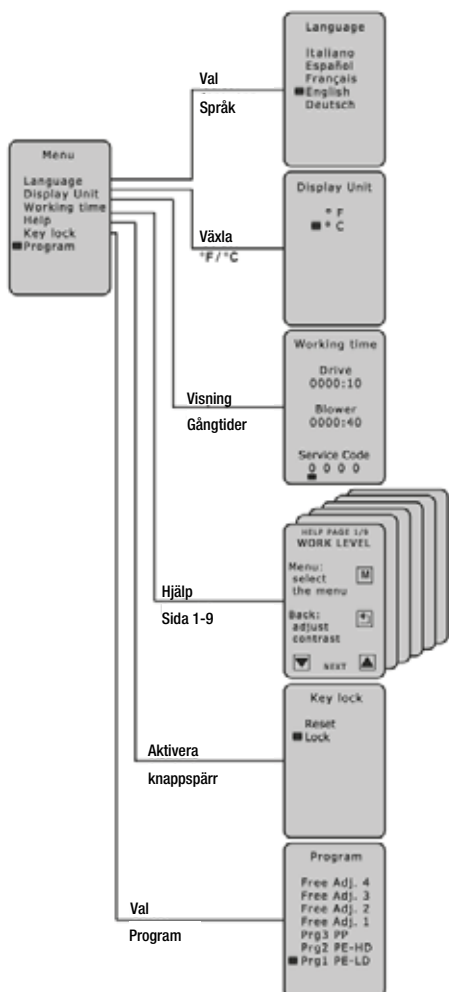

Felmeddelanden

Om ett fel uppstår tonas detta in i **statusvisningen (30)** (t.ex. **Err04** Motorn är överhettad).

Visning **ErrXX**

Om det uppstår ett fel slås uppvärmningarna för AIR och PLAST samt drivmotorn från omgående!
Om detta inte sker ska apparaten skiljas från elnätet omgående!

Fortsatt tillvägagångssätt vid statusvisning drivning (30) **ErrXX**

- Notera felkoden
- Lossa **låsning drivning (4)** och släpp **till-/frånbrytare drivning (2)**.
- Stäng av **huvudströmbrytaren (1)**.
- Ta apparaten i övervakad drift igen och kontrollera att handextrudern inte överhettas utifrån.
- Stöt om möjligt ut den plast som är kvar i skruven.
- Om felet uppstår igen ska apparaten skickas till serviceverkstaden för kontroll under angivande av felkoden.

Följande fel identifieras av apparaten:

Visning	Typ av fel
Err01	Övertemperatur i luften eller defekt temperatursond
Err02	Övertemperatur i plastmassan eller defekt temperatursond
Err04	Övertemperatur i motorlindningen, motorn är överhettad
Err08	Övertemperatur i värmeelement AIR eller bortfall av fläktmotor
Err10	Övertemperatur i elektroniken
Err40	Kortslutning i temperatursonden PLAST

Om flera fel uppstår samtidigt, t.ex. **Err02** och **Err04**, visas **Err06**.

Fler kombinationer visas med bokstäverna A, B, C, D, E och F, t.ex. **Err08** och **Err02** visning **Err0A**.

Övertemperaturskydd drivning

Om drivningen överhettas genom yttre påverkan eller vid låga PLAST-temperaturer slår det interna temperaturskyddet från drivningen (se **Err04**).

Startskydd drivning

Drivmotorn är skyddad mot automatisk start efter fel, t.ex. överhettning **Err04**. Visningen «Slå från drivningen» visas på **displayen (5)** om drivmotorn stannar i blockerat tillstånd. När felet har åtgärdats och frångkopplingen av drivningen (**lossa spärr drivning (4)** och släpp **till-/frånbrytare drivning (2)**) slocknar visningen «Slå från drivningen» på **displayen (5)**. Det går att arbeta vidare.

Byte av tillbehör



Risk för brännskador!



Arbeta endast med temperaturbeständiga handskar.

Byte av svetssko

Bytet av svets skor måste göras på apparaten när den är driftvarm.

Demontering

- Slå från den driftvarma apparaten och skilj den från elnätet
- Ta bort **svetsskon (8)** med **svetsskohållaren (34)** genom att lossa **klämskruvarna (35)** till **extruderingsmunstycket (32)**.
- Rengör **extruderingsmunstycket (32)** från svetsmaterialrester och kontrollera att det är fästskruvat vid varje byte av svets sko
- Ta bort **svetsskon (8)** genom att lossa **fästsruvarna (33)** till **svetsskohållaren (34)**.

Montering

- Montera en **svetssko (8)** som är anpassad till svetsfogen på **svetsskohållaren (34)** med **fästsruvar (33)**.
- **Svetsskon (8)** och **svetsskohållaren (34)** måste dras åt ordentligt med **klämskruvarna (35)**.

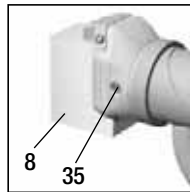
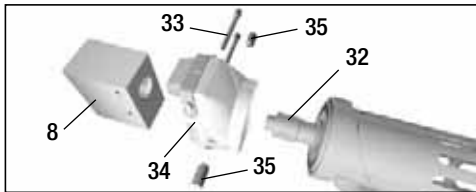

- 8 Svetssko
- 32 Extruderingsmunstycke
- 33 Fästsruvar
- 34 Svetsskohållare
- 35 Klämskruv

Svetsriktning

Det går att vrida **svetsskon (8)** steglöst i önskad svetsriktning genom att man lossar **klämskruvarna (35)**. **Klämskruvarna (35)** måste sedan dras åt ordentligt igen.

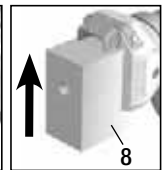
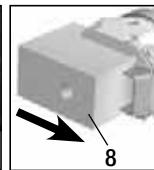
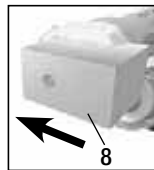

Byte av hetluftstyrning

För demonteringen av **hetluftstyrningen (44)** tas först **svetsskon (8)** bort. När den kontrade **fixeringsskruven (45)** på **rörklämman (10)** och **klämskruven (47)** på hetluftstyrningens förbindelseslang har lossats kan hela enheten dras av.

Montering i omvänd ordning.

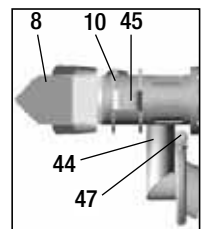

Byte av förvärmningsmunstycket

Demontering: Lossa **klämskruven (43)** vid **förvärmningsmunstycket (9)** och dra av **förvärmningsmunstycket (9)** från **hetluftstyrningen (44)**.

Montering: Skjut på **förvärmningsmunstycket (9)** på **hetluftstyrningen (44)**.
Kontrollera att inriktningen mot munstycksskon är parallell.
Dra åt **klämskruven (43)**.

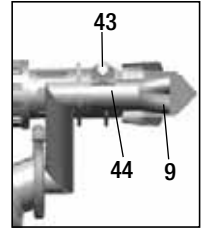

Förvärmningsmunstycken för apparater med extern luftstyrning

Det finns tre olika **förvärmningsmunstycken (9)** som motsvarar svetsfogsbredderna att välja mellan. Munstyckenas tvärsnitt motsvarar DVS-riktlinjerna.



Svetsskosortiment

Leister Technologies AG har lämpliga svetskor för alla vanliga fogformer i diverse olika storlekar:

WELDPLAST S2 / WELDPLAST S2-TPO med integrerad luftstyrning

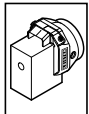

Råämne

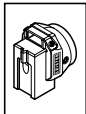

V-fog



Kälsvets

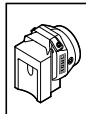

Över-
lappande
fog

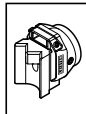

Hörnskarv
utvändigt

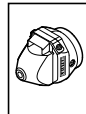

Hörnskarv
kort

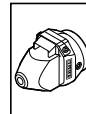

Hörnskarv
lång



Vinkelhuvud
45°



90°

WELDPLAST S2 / WELDPLAST S2-PVC med extern luftstyrning

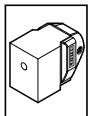

Råämne

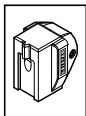

V-fog

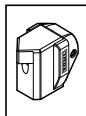

Kälsvets

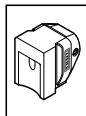

Över-
lappande
fog

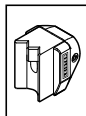

Hörnskarv
utvändigt

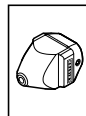

Hörnskarv
kort

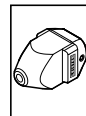

Hörnskarv
lång

Tillbehör

Av tekniska och säkerhetsrelevanta skäl får endast Leisters tillbehör användas.

Apparat- förvaringsplats



Transportabel trådvullningsanordning

- Anordningen är utformad för svetstrådsrullar med \varnothing 300 mm
- För att garantera en optimal avlindning av tråden ska svetstråden föras genom den **ögla (41)** som är avsedd för detta

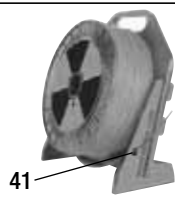

Skötsel

- Kontrollera **nätkabeln (14)** och kontakten med avseende på elektriska och mekaniska skador
- Befria **extruderingsmunstycket (32)** från svetsmaterialrester vid varje byte av svetssko

Service och reparation

- Reparationer får endast utföras av auktoriserade **Leister-serviceverkstäder**. Dessa garanterar en korrekt och tillförlitlig **reparationservice** med originalreservdelar enligt kopplingsscheman och reservdelslistor inom 24 timmar.
- Om servicevisningen med **servicekod 1** visas efter tillslag av apparaten vid WELDPLAST S2 ska kolnivån kontrolleras av en behörig **Leister-serviceverkstad** och drivningens kolborstar ska bytas vid behov.
- Visningen kan tonas ut igen med **Select-knappen (28)**
- Det går att arbeta vidare med handextrudern en kort tid. 
- Om inte kolborstarna byts inom användningsintervallet kör drivningen tills det mekaniska kolstoppet uppnås. Inget felmeddelande visas på displayen men drivningen går inte längre.



Garanti

- För den här enheten gäller den direkta distributionspartnerns/försäljarens garantivillkor från och med köpdatumet. Vid garantianspråk (styrks med faktura eller följesedel) åtgärdar distributionspartnern tillverknings- eller bearbetningsfel genom tillhandahållande av reservdelar eller reparation. Garantin omfattar inte värmeelement.
- Ytterligare garantianspråk utesluts inom ramen för bindande lagstiftning.
- Skador till följd av normalt slitage, överbelastning eller felaktig hantering täcks inte av garantin.
- Garantianspråk gäller inte för enheter som har manipulerats eller ändrats av köparen.



© Copyright by Leister

Your authorised Service Centre is:

Leister Technologies AG
Galileo-Strasse 10
CH-6056 Kaegiswil/Switzerland
Tel. +41 41 662 74 74
Fax +41 41 662 74 16
www.leister.com
sales@leister.com

BA WELDPLAST S2/S2-PVC/S2-TPO
Art. 118.603 part 1/07.2007/01.2016