

LEISTER®

D	2
GB	21
F	40
I	59
E	78
NL	97

WELDPLAST S1



Leister Technologies AG
Galileo-Strasse 10
CH-6056 Kaegiswil/Switzerland
Tel. +41 41 662 74 74
Fax +41 41 662 74 16
www.leister.com
sales@leister.com



Bedienungsanleitung vor Inbetriebnahme aufmerksam lesen und zur weiteren Verfügung aufbewahren.

Leister WELDPLAST S1 Hand-Schweissextruder

Anwendung

- Extrusionsschweißen von folgenden Materialien:
PP / PE-HD / PVC-U / PVC-C / PVDF
- Weitere Materialien auf Anfrage



Warnung



Lebensgefahr beim Öffnen des Gerätes, da spannungsführende Komponenten und Anschlüsse freigelegt werden. Vor dem Öffnen des Gerätes Netzstecker aus der Steckdose ziehen.



Feuer- und Explosionsgefahr bei unsachgemäßem Gebrauch des Hand-Schweissextruders (z.B. Überhitzung von Material) besonders in der Nähe von brennbaren Materialien und explosiven Gasen.



Verbrennungsgefahr! Blanke Metallteile und austretende Masse nicht in heissem Zustand berühren. Gerät abkühlen lassen. Heissluftstrahl und austretende Masse nicht auf Personen oder Tiere richten.



Gerät an eine **Steckdose mit Schutzleiter** anschliessen. Jede Unterbrechung des Schutzleiters innerhalb oder ausserhalb des Gerätes ist gefährlich!
Nur Verlängerungskabel mit Schutzleiter verwenden!



Vorsicht



Nennspannung, die auf dem Gerät angegeben ist, muss mit der Netzspannung übereinstimmen.
Bei Ausfall der Netzspannung müssen Hauptschalter und Antrieb ausgeschaltet werden (Arretierung lösen).



FI-Schalter beim Einsatz des Gerätes auf Baustellen ist für den Personenschutz **dringend erforderlich**.



Blendungsgefahr! Direkter Blickkontakt mit dem LED-Lichstrahl ist zu vermeiden. Gerät **muss beobachtet** betrieben werden. Wärme kann zu brennbaren Materialien gelangen, die sich ausser Sichtweite befinden.
Gerät darf nur von **ausgebildeten Fachleuten** oder unter deren Aufsicht benützt werden. Kindern ist die Benützung gänzlich untersagt.



Gerät vor Feuchtigkeit und Nässe schützen.

Konformität

Leister Technologies AG, Galileo-Strasse 10, CH-6056 Kaegiswil/Schweiz bestätigt, dass dieses Produkt in der von uns in Verkehr gebrachten Ausführung die Anforderungen der folgenden EG-Richtlinien erfüllt.

Richtlinien: 2006/42,
2004/108 (bis 19.04.2016), 2014/30 (ab 20.04.2016),
2006/95 (bis 19.04.2016), 2014/35 (ab 20.04.2016),
2011/65

Harmonisierte Normen: EN 12100, EN 55014-1, EN 55014-2, EN 61000-6-2, EN 61000-3-2,
EN 61000-3-3, EN 62233, EN 60335-1, EN 60335-2-45, EN 50581

Kaegiswil, 04.02.2016

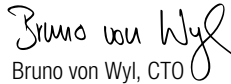
Bruno von Wyl, CTO

Andreas Kathriner, GM

Entsorgung



Elektrowerkzeuge, Zubehör und Verpackungen sollen einer umweltgerechten Wiederverwertung zugeführt werden. **Nur für EU-Länder:** Werfen Sie Elektrowerkzeuge nicht in den Hausmüll!

Technische Daten

Spannung	V~	100	120	230
Leistung	W	1500	1800	1600
Frequenz	Hz	50/60	50/60	50/60
Luft-Temperatur	°C	max. 360		
Plastifizier-Temperatur	°C	max. 260		
Ausstoss (Ø 3 mm)	kg/h	HD-PE 0.2–0.5; PP 0.2–0.5		
Ausstoss (Ø 4 mm)	kg/h	HD-PE 0.3–0.8; PP 0.3–0.75		
Schweisdraht	mm	Ø 3 / Ø 4		
Emissionspegel	L _{pA} (dB)	76 (K = 3 dB)		
Masse L × B × H	mm	435 × 264 × 91 (ohne Schweissschuh)		
Gewicht	kg	4.7 (ohne Netzanschlussleitung)		
Konformitätszeichen		CE	CE	CE
Sicherheitszeichen				⚡
Schutzklasse I		⊥	⊥	⊥

Technische Änderungen vorbehalten

Gerätebeschreibung

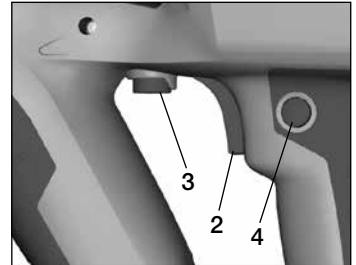
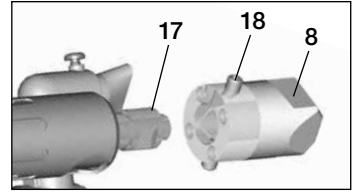
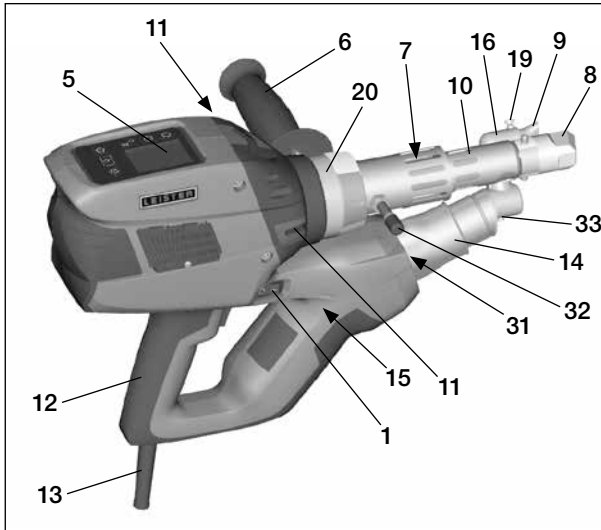

- 1 Hauptschalter
- 2 Ein-/Ausmacher Antrieb
- 3 Potentiometer
- 4 Arretierung Antrieb
- 5 Display
- 6 Handgriff
- 7 Mantelheizung
- 8 Schweisssschuh
- 9 Vorwärmdüse
- 10 Schutzrohr
- 11 Schweißdraht-Einführung
- 12 Gerätegriff

- 13 Netzanschlussleitung
- 14 Heizelement - Schutzrohr
- 15 Gebläse (bürstenlos)
- 16 Heissluftführung
- 17 Extrudierdüse
- 18 Klemmschraube Schweisssschuh
- 19 Klemmschraube Vorwärmdüse
- 20 Klemmschelle
- 31 LED-Beleuchtung
- 32 Ablagebolzen
- 33 Klemmschraube Heissluftführung

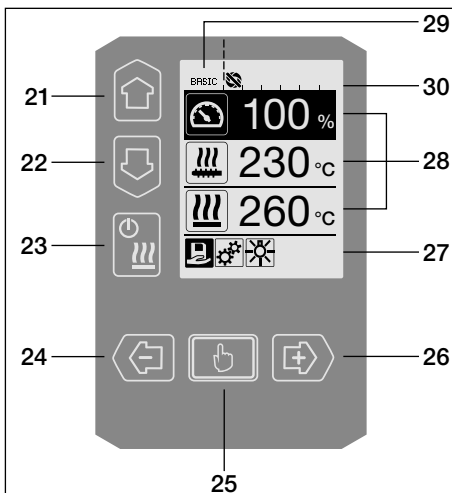

Bedieneinheit

- 21 Taste «Auf»
- 22 Taste «Ab»
- 23 Taste Heizung «Ein / Aus»
- 24 Taste «Minus»
- 25 Taste «Bestätigen»
- 26 Taste «Plus»

Display

- 27 Funktionsanzeige
- 28 Arbeitsanzeige
- 29 Statusanzeige «Bereich 1»
- 30 Statusanzeige «Bereich 2»

Bedieneinheitsbeschreibung





Tastaturmodus		Aktuelle Auswahl in der Arbeitsanzeige	Aktuelle Auswahl in der Funktionsanzeige
 	Auf (21) Ab (22)	Verändern der Position innerhalb der Arbeitsanzeige	Wechsel von der Funktionsanzeige in die Arbeitsanzeige
	Heizung Ein / Aus (23)	Keine Funktion	Wechsel vom Schweißmodus in Abkühlvorgang Wechsel von Abkühlvorgang in den Schweißmodus Wechsel von Startanzeige in den Schweißmodus
 	Minus (24) Plus (26) (kurz drücken)	Einstellen des gewünschten Sollwertes in 5°C - bzw. 5% - Schritten.	Verändern der Position in der Funktionsanzeige
 	Minus (24) Plus (26) (drücken und halten)	Einstellen des gewünschten Sollwertes in 10°C - bzw. 10% - Schritten.	Verändern der Position in der Funktionsanzeige
	Bestätigen (25)	Eingestellter Wert wird direkt übernommen und die Auswahl springt direkt in die Funktionsanzeige zurück	Ausgewählte Funktion wird ausgeführt

Displaybeschreibung

Statusanzeige «Bereich 1» (29)

PE-HD	Aktuell ausgewähltes Profil. Bei Profilenames mit mehr als 6 Zeichen werden zuerst die ersten 6 Zeichen angezeigt, anschliessend die verbleibenden Zeichen.
1m16s	Verbleibende Zeit bis Antrieb freigegeben wird (1 min. / 16 sek.)

Statusanzeige «Bereich 2» (30)

	Antrieb freigegeben
	Antrieb nicht freigegeben
	Warnung vorhanden (Kohlenbürsten / Antrieb)
	Tastensperre (erscheint nur bei aktiver Tastensperre)
	Luft- und Plastifizier-Heizung ist eingeschaltet

Funktions- und Arbeitsanzeige

- In der Funktions- und Arbeitsanzeige definiert immer das markierte dargestellte Feld oder Symbol die aktuelle Auswahl.
- In der Arbeitsanzeige werden immer die Istwerte angezeigt, ausser wenn eine Position ausgewählt ist, erscheint der Sollwert.
- Ist «Show Set Values» aktiviert erscheint der Ist- und Sollwert (klein).

Funktionsanzeige (27)	
	Freie und vordefinierte Profile auswählen
	Einstellungen
	Zurück zur Arbeitsanzeige (direktes Verlassen eines Menüs)
	LED ein-/ ausschalten. Diese Funktion ist nur vorhanden, wenn die LED aktiviert wurde.
	Eine Ebene zurück
	Einstellungen oder Stundenzähler zurücksetzen
	Service Menü (nur über Passworteingabe verfügbar)
	Speichern
	Ausgewählte Position löschen
	Ausgewählte Position bearbeiten
	Abkühlvorgang einleiten

Arbeitsanzeige (28)	
	Sollwert: Ausstossmenge Antrieb [%]
	Sollwert: Plastifizier-Temperatur [°C / °F]
	Sollwert: Luft-Temperatur [°C / °F]
	Sollwert: Luftmenge [%]
	Informationsfenster
	Der Pfeil nach oben und der Fortschrittsbalken zeigen an, dass der Sollwert (Markierung im Fortschrittsbalken) noch nicht erreicht ist (zu kalt). Der blinkende Wert ist der Istwert. Der Wert neben dem Fortschrittsbalken ist der eingestellte Sollwert.
	Der Pfeil nach unten und der Fortschrittsbalken zeigen an, dass der Sollwert (Markierung im Fortschrittsbalken) noch nicht erreicht ist (zu heiss). Der blinkende Wert ist der Istwert. Der Wert neben dem Fortschrittsbalken ist der eingestellte Sollwert.
	Ist «Show Set Values» aktiviert, wird die Isttemperatur (gross) und die Solltemperatur (klein) dargestellt.
	Abkühlvorgang
	Gerät im Standby-Modus. Das Gerät wird nach Ablauf des Zählers den «Cool down modus» starten
	Gerät hat einen Fehler. Zusätzlich erscheint ein Fehlercode (Gerät nicht mehr einsatzbereit). Autorisierte Service-Stelle kontaktieren
	Heizelement-Luft defekt
	Gerätetemperatur zu hoch. Gerät abkühlen lassen.

Übersicht der Arbeitsanzeige

Aufstartanzeige

Anzeige beim Aufstart mit Software Release der Leistungseinheit.



Cool down mode (Abkühlen)

In diesem Modus sind die Heizungen ausgeschaltet und das Gerät ist im Abkühlmodus. Ist beim Einschalten des Gerätes die Vorwärmfluttemperatur grösser als 100 °C, wechselt das Gerät automatisch in den «Cool down mode». Der Vorgang ist abgeschlossen, wenn die Vorwärmfluttemperatur 2 min. unter 100 °C liegt. Sollen die Heizungen wieder eingeschaltet werden, muss die **Taste (23)** «Heizung Ein/Aus» oder die **Taste (25)** «Bestätigen» gedrückt werden.

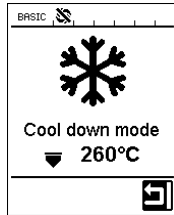

Maintenance servicing (Wartungsservice)

Ist das Wartungsintervall für den Antriebsmotor erreicht, erscheint nach der Aufstartanzeige «Maintenance Servicing». Mittels **Taste (25)** «Bestätigen» kann weiter gearbeitet werden. Das Gerät muss zwingend zu Ihrer Servicestelle gebracht werden.



Startanzeige

In der Startanzeige werden alle Sollwerte dargestellt. Die Heizung ist noch nicht eingeschaltet, es können jedoch alle Sollwerte bereits eingestellt werden.

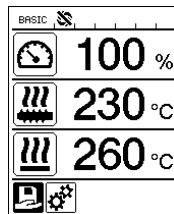

Aufstartanzeige Schweißen

Anzeige während dem Aufheizvorgang

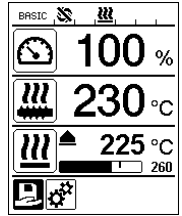

Select Profile (Profilauswahl)

Wählen Sie ein von Ihnen definiertes oder ein durch Leister vorgegebenes Profil aus. Die Profilauswahl ist unter dem Kapitel «Select Profile» Seite 13 detailliert beschrieben.

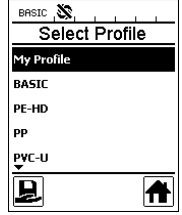

Setup (Einstellung)

In der Grundeinstellung gelangen Sie über das Menü «Setup» in die Profilspeicherung und in die Standbyfunktion. Durch auswählen des «Advanced Mode» stehen diverse weitere Einstellungsmöglichkeiten zur Verfügung.

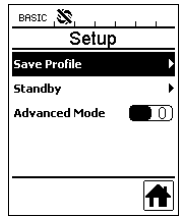

Save profile (Freie Profile definieren)

Die freie Profilspeicherung ist unter dem Kapitel «Profile definieren» Seite 15/16 detailliert beschrieben.

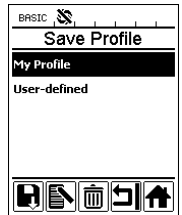

Übersicht der Arbeitsanzeige

Standby (Bereitschaft)

Ist der Standbymodus aktiviert und wird während der unter «**Standby Interval**» definierten Zeit keine Taste auf der Bedieneinheit oder der **Ein- / Ausschalter Antrieb (2)** betätigt, wechselt das Gerät automatisch in die Standbyanzeige. Wird während den folgenden 180 sek. die **Taste (25)**  «**Bestätigen**» nicht gedrückt, startet automatisch der Abkühlmodus.

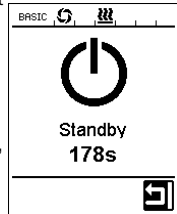
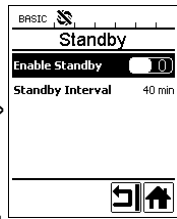

Duty Info

Hours Drive: aktuelle Laufzeit des Antriebs (rückstellbar).
 Hours Blower: aktuelle Laufzeit des Gebläses.
 Hours Machine: aktuelle Laufzeit der Maschine.

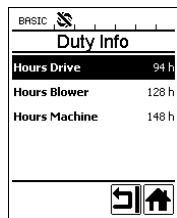

General Info

Firmware HMI: Softwareversion der Displayeinheit (Kommunikationsmodul).
 Firmware Machine: Softwareversion Leistungseinheit.
 Production Info: Angaben zum Produktionszeitpunkt.

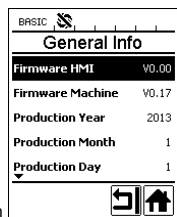

Warnings

Liegt eine Warnung vor, wird dies in der Statusanzeige durch das Symbol  signalisiert. Im Menü «Warnings» finden Sie genauere Angaben zur aktuellen Warnung.

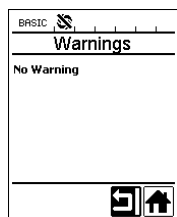

Machine Setup

Die Einstellungen der Maschine sind unter dem Kapitel «Maschinen Einstellungen» detailliert beschrieben.

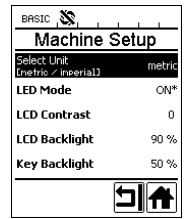

Application Mode

Ist der «Application Mode» aktiviert, haben Sie in der Arbeitsanzeige detaillierte Angaben zur Ist-Plastifizier-Temperatur und Auslastung von Heissluftgebläse und Plastifizier-Heizung.

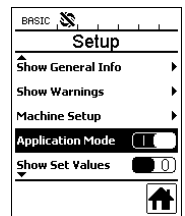

 Plast: 80 % 222 °C
 Heat: 40 % 197 °C
 Amb.: 25 °C
 Mains: 50Hz

Ist «Show Set Values» aktiviert, wird die Ist-Temperatur (gross) und die Soll-Temperatur (klein) dargestellt.

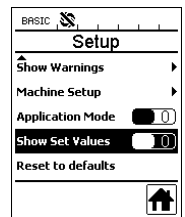

Reset to defaults

Wird das Menü «Reset to defaults» ausgewählt und durch Auswählen der Funktion  bestätigt, werden sämtliche Kundenspezifischen Profile gelöscht. Einstellungen welche über das Setup Menü verändert wurden, werden auf Werkseinstellung zurückgesetzt.

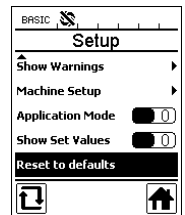



Vor Inbetriebnahme Netzanschlussleitung (13) und Stecker sowie Verlängerungskabel auf elektrische und mechanische Beschädigung überprüfen.

Der Hand-Schweissextruder darf nicht in explosionsgefährdeter bzw. entzündbarer Umgebung eingesetzt werden. Auf sicheren Stand bei der Arbeit achten. Netzanschlussleitung und Schweißdraht müssen frei beweglich sein und dürfen den Anwender oder Dritte bei der Arbeit nicht behindern.

Hand-Schweissextruder auf feuerfeste Unterlage stellen! Heisse Metallteile und Warmluftstrahl müssen genügend Abstand zu Unterlage und Wänden haben.

Arbeitsplatz



Zur Inbetriebnahme und Ablage des Hand-Schweissextruders bietet Leister eine **Geräteablage** an.

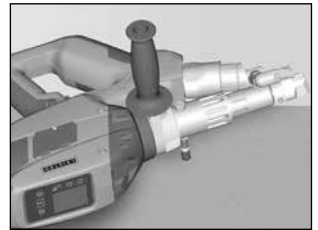
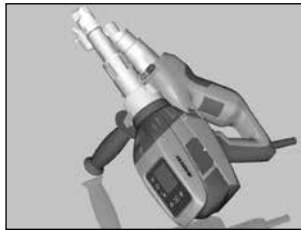

Bei Unterbruch der Schweißarbeiten ist der Antrieb mit dem **Ein-/Aus-schalter Antrieb (2)** abzuschalten.

Den Hand-Schweissextruder mit entsprechend eingestelltem und fest angezogenem **Handgriff (6)** gemäss Abbildung auf eine stabile, feuerfeste Unterlage oder **Ablagebolzen (32)** stellen.

Handgriff

Einstellung Handgriff

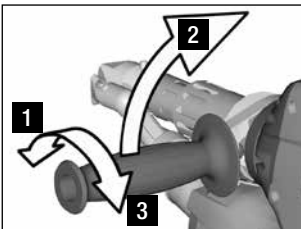

- 1 Durch Drehen des **Handgriffs (6)** gegen den Uhrzeigersinn Klemmung lösen.
- 2 **Handgriff (6)** in die gewünschte Arbeitsposition bringen.
- 3 Durch Drehen des **Handgriffs (6)** im Uhrzeigersinn Klemmung wieder festziehen.

Demontage / Montage Handgriff

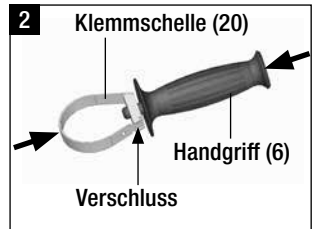
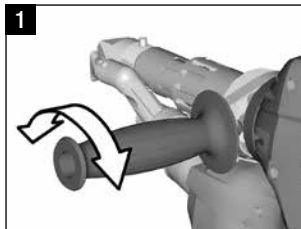

Verbrennungsgefahr! Gerät abkühlen lassen

Demontage Handgriff

- 1 Durch Drehen des **Handgriffs (6)** gegen den Uhrzeigersinn Klemmung lösen.
- 2 Mittels Drücken auf den **Handgriff (6)** und auf die **Klemmschelle (20)** öffnet sich der **Verschluss (siehe Pfeile)**. **Handgriff (6)** mit **Klemmschelle (20)** entnehmen.

Montage Handgriff erfolgt in umgekehrter Reihenfolge.

Verlängerungskabel

- Bei Verwendung von Verlängerungskabeln auf den Mindestquerschnitt achten:
- Verlängerungsleitung muss für den Einsatzort (z.B. im Freien) zugelassen und entsprechend gekennzeichnet sein.
- Bei Verwendung eines Aggregates zur Energieversorgung gilt für dessen Nennleistung: $2 \times$ Nennleistung Hand-Schweissextruder.

Länge [m]	Mindest-Querschnitt (bei 100 – 230V~) [mm ²]
Bis 19	2.5
20 – 50	4.0

Starten des Gerätes

- Nach Bedarf den entsprechenden **Schweissschuh (8)**, die entsprechende **Vorwärmdüse (9)** sowie die **Heissluftführung (16)** montieren (Wechsel von Zubehör Seite 18).



Gerät an Nennspannung anschliessen. Nennspannung, die auf dem Gerät angegeben ist, muss mit der Netzspannung übereinstimmen.

- Schalten Sie den Extruder über den **Hauptschalter (1)** ein. Je nach Vorwärmdufttemperatur erscheint auf dem **Display (5)** die Aufstartanzeige oder «Cool down mode». Durch Drücken der **Taste (23) «Heizung Ein / Aus»** , wird der Aufheizvorgang gestartet.
- Ist das Gerät betriebsbereit, schaltet die **LED-Beleuchtung (31)** automatisch ein (Werkseinstellung).
- Mittels **Ein-/Ausschalter Antrieb (2)** kann der Antrieb gestartet werden.

Schweissvorgang

- Schweißdraht (\varnothing 3 oder 4 mm) in die **Schweißdraht-Einführung (11)** einführen.
- Der Schweißdraht wird automatisch durch die **Schweißdraht-Einführung (11)** eingezogen. Drahtzuführung muss ohne Widerstand erfolgen.



ACHTUNG!

Gerät immer mit Schweißdraht betreiben, jedoch niemals gleichzeitig in beide Schweißdraht-Einführungen Schweißdraht einführen.

- Mittels **Potentiometer (3)** kann die Geschwindigkeit des Schweißdraht einzuges eingestellt werden.
- Masseförderung mit **Ein-/Ausschalter Antrieb (2)** unterbrechen.
- Die **Vorwärmdüse (9)** auf die Schweisszone richten.
- Mit pendelnden Bewegungen die Schweisszone vorwärmen.
- Das Gerät auf die vorbereitete Schweisszone aufsetzen und den **Ein-/Ausschalter Antrieb (2)** wieder betätigen.
- Testschweissung gemäss Schweissanleitung des Materialherstellers und nationaler Normen oder Richtlinien vornehmen. Testschweissung überprüfen.
- Temperatureinstellung, Ausstossmenge und Luftmenge nach Bedarf anpassen (siehe Kapitel, Einstellen Schweissparameter, Seite 12).
- Bei einem längeren Schweissvorgang kann der **Ein-/ Ausschalter Antrieb (2)** mittels **Arretierung Antrieb (4)** im Dauerbetrieb gehalten werden.

ACHTUNG!

- PVC-U und PVC-C werden im Menü vom PVC-U verarbeitet.
- Um Korrosionsschäden beim Verarbeiten von PVC-U, PVC-C, ECTFE, PVDF etc. zu vermeiden, empfehlen wir nach Beendigung der Schweissarbeiten den Hand-Schweissextruder mit HD-PE zu spühlen.





Ausschalten des Gerätes

- **Arretierung Antrieb (4)** lösen und den **Ein-/Ausschalter Antrieb (2)** loslassen.
- Schweißmaterial im **Schweissschuh (8)** entfernen.
- Durch Drücken der **Taste (23) «Heizung Ein / Aus»**  und mittels **Taste (25) «Bestätigen»** wird die Heizung ausgeschaltet und das Gerät startet den Abkühlvorgang «Cool down mode».
- Nach dem Abkühlvorgang schaltet das Gebläse automatisch ab und auf dem **Display (5)** erscheint die Startanzeige.
- **Hauptschalter (1)** ausschalten.



Netzanschlussleitung vom elektrischen Netz trennen.

Einstellen eines Parameters

- Muss eine Sollwertvorgabe (z.B Soll- Plasttemperatur) verändert werden, kann durch Drücken der **Tasten 21 / 22 «Auf»**  **oder «Ab»**  der entsprechende Sollwert ausgewählt werden. Solange der Sollwert markiert dargestellt wird, kann er über die **Tasten 24 / 26 «Plus»**  **oder «Minus»**  verändert werden. Beim WELDPLAST S1 sind vier Sollwerte einstellbar:



Ausstossmenge (max. Ausstoss wenn Potentiometer auf Stufe 5 steht, bzw. auf 100% eingestellt ist).



Plastifizier-Temperatur





Luft-Temperatur

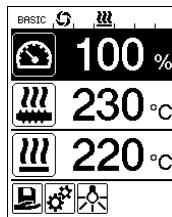

Luftmenge

- In der Arbeitsanzeige können max. drei Elemente dargestellt werden.



- Weitere Elemente werden durch Drücken der **Tasten 21 / 22 «Auf»**  **oder «Ab»**  erreicht.

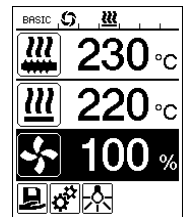



- Die Ausstossmenge kann während dem Extrudieren direkt über das **Potentiometer (3)** in 5%-Schritten verstellt werden. Der Bereich geht dabei von min. 35% bis zur max. eingestellten Ausstossmenge. Der aktuell eingestellte Wert ist dabei immer in der Arbeitsanzeige sichtbar. Der in der Arbeitsanzeige eingestellte Wert ist als Maximum-Wert zu verstehen. Mit dem **Potentiometer (3)** kann nur bis zu diesem eingestellten Maximum-Wert eingestellt werden. Typischerweise ist dieser deshalb auf 100% eingestellt.
- Ist die Ausstossmenge mit dem minimalen Ausstoss (35%) zu gross, muss auf die Schweißdrahtdicke 3 mm gewechselt werden.
- Ist die Ausstossmenge mit dem maximalen Ausstoss (100%) zu klein, muss auf die Schweißdrahtdicke 4 mm gewechselt werden.

Select Profile (Profilauswahl)

- Auswahl eines vordefinierten oder freien Profils
- Der WELDPLAST S1 verfügt über sechs vordefinierte Leister-Profile und bis zu zehn frei definierbare Profile:

Schweißprofile		Max. Ausstoss [%]	Soll- Plastifizier-Temperatur [°C / °F]	Soll- Luft-Temperatur [°C / °F]	Luftmenge [%]
1	BASIC	einstellbar	einstellbar	einstellbar	einstellbar
2	PE-HD	100	230	260	100
3	PP	100	240	260	100
4	PVC-U	100	200	300	100
5	PVDF	100	250	320	100
6 – 16	freie Profile	einstellbar	einstellbar	einstellbar	einstellbar

- Durch die Auswahl des Symbols  in der **Funktionsanzeige (27)** gelangen Sie in das Menü «Select Profile». Eines dieser sechs vordefinierten (1 – 6) oder ein kundenspezifisches freies Profil (7 – 16) kann mit den **Tasten 21/ 22 «Auf»**  und **«Ab»**  ausgewählt werden.
- Werden Sollwerte (Profile 2 – 16) während dem Betrieb verändert, werden diese nicht im Profil gespeichert!
- Wird die Maschine aus- / eingeschaltet, erscheinen immer wieder die im Profil definierten Werte.
- Möchten Sie beim Wiedereinschalten der Maschine die zuletzt eingestellten Werte benutzen, müssen Sie das Profil BASIC (1) auswählen.
- Das aktuell ausgewählte Profil ist links in der **Statusanzeige «Bereich 1» (29)** sichtbar.

PE-HD 

Überwachung der Schweißparameter

- Die aktuelle Plastifizier- und Luft-Temperatur wird ständig überwacht. Weicht ein Istwert vom entsprechenden Sollwert ab, wird dies in der **Arbeitsanzeige (28)** angezeigt («Show Set Values» nicht aktiviert).

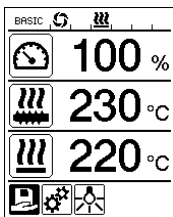

- Istwert entspricht dem Sollwert.

28

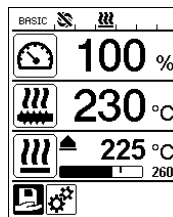

- Istwert Luft-Temperatur zu tief. Aufheizvorgang wird blinkend signalisiert (Pfeil nach oben und Fortschrittsbalken).

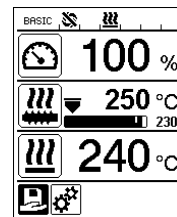

- Istwert Plastifizier-Temperatur zu hoch. Abkühlvorgang wird blinkend signalisiert (Pfeil nach unten und Fortschrittsbalken).

Freigabe Antrieb

- Für die Freigabe des Antriebs gibt es vier verschiedene Wartezeiten (siehe Tabelle). Diese sind von der Ist-Plastifizier-Temperatur sowie von der eingestellten Soll-Plastifizier-Temperatur abhängig. Die Vorwärmflucht hat keinen Einfluss auf die Freigabe des Antriebs.
- Die Freigabezone beginnt, sobald die Ist-Plastifizier-Temperatur grösser als die Solltemperatur – 20K ist.
- **Zugehöriges Symbol in der Statusanzeige:**



Antrieb ist nicht freigegeben





Antrieb freigegeben

Ist-Plastifizier-Temperatur beim Einschalten der Heizung oder verstellen der Soll-Plastifizier-Temperatur	Soll-Plastifizier-Temperatur	Freigabezeit nach Erreichen der Freigabezone
Soll-Plastifizier-Temperatur – 5K < Ist-Plastifizier-Temperatur	—	Antrieb wird direkt freigegeben
Soll-Plastifizier-Temperatur – 20K < Ist-Plastifizier-Temperatur < Soll-Plastifizier-Temperatur – 5K	—	30 sek.
Soll-Plastifizier-Temperatur – 20K > Ist-Plastifizier-Temperatur (Unterhalb der Freigabezone)	> 190°C	2 min. 30 sek
Soll-Plastifizier-Temperatur – 20K > Ist-Plastifizier-Temperatur (Unterhalb der Freigabezone)	< 195°C	3 min. 30 sek

- Kann der WELDPLAST S1 die Ist-Plastifizier-Temperatur bei freigegebenem Antrieb für mehr als 10 sek. nicht in der Freigabezone halten, wird der Antrieb wieder gesperrt. Sobald das Gerät die Freigabezone wieder erreicht hat, wird der Antrieb nach einer in der Tabelle definierten Zeit wieder freigegeben.

Tastensperre





- Durch gleichzeitiges Drücken von mindestens zwei Sekunden der **Tasten 21 / 22 «Auf»**  **und «Ab»**  wird die Tastensperre aktiviert bzw. deaktiviert.

Netzunterbruch





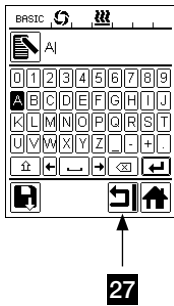

Zustand Antrieb vor Netzunterbruch	Dauer Netzunterbruch	Zustand WELDPLAST S1 nach Netzunterbruch
Antrieb freigegeben Arbeitsanzeige Schweißen	≤ 5 sek	Das Gerät startet ohne Wiederanlaufschutz auf und wechselt direkt in den Zustand vor dem Netzunterbruch
Antrieb freigegeben (Vorwärmflucht > 100 °C)	> 5 sek	Das Gerät wechselt direkt in den «Cool down modus»
Antrieb freigegeben (Vorwärmflucht < 100 °C)	> 5 sek	Das Gerät startet und auf dem Display (5) erscheint die Startanzeige.

Eingabe von Namen oder Passwörtern













- Über den Tastaturmodus können Namen definiert oder Passwörter mit maximal 12 Zeichen eingegeben werden.

Tastaturmodus	Zeichenauswahl 34	Symbolauswahl 35
 	Auf (21) Ab (22)	Vertikale Zeichenauswahl
 	Minus (24) Plus (26)	Horizontale Zeichenauswahl Auswahl der Symbole
	Bestätigen (25)	Das ausgewählte Zeichen bestätigen Das ausgewählte Symbol bestätigen



	Wechsel zwischen Gross- und Kleinschreibung
 	Cursorposition im Namen verschieben
	Leerschlag einfügen
	Löschen eines einzelnen Zeichens (Zeichen links von Cursor)
	Durch Auswählen dieses Symbols Wechsel auf Funktionsanzeige 27

Profile definieren

- Im Menü «Save Profile» können Sollwerteneinstellungen der max. Ausstossmenge, Plastifizier- Luft-Temperatur und Luftleistung unter einem von Ihnen gewünschten Namen abgespeichert werden (siehe Kapitel «Eingabe von Namen oder Passwörtern»).
- Erstellen eines neuen Profils:**
 - In der **Arbeitsanzeige (28)** gewünschte Sollwerte mittels **Tasten 24/26 «Plus»**  oder **«Minus»**  einstellen.
 - In der **Funktionsanzeige (27)** mit **Taste 26 «Plus»**  das Menü Einstellungen  auswählen.
 - Im Menü «Setup» die Auswahl mit **Taste 26 «Plus»**  «Save Profile» auswählen.
 - Das Profil «User-defined» auswählen und mittels **Taste (25)**  bestätigen.
 - In der **Funktionsanzeige (27)** das Symbol  «Ausgewählte Position bearbeiten» auswählen und mittels **Taste (25)**  bestätigen.
 - Gewünschten Profilnamen eingeben (siehe Kapitel «Eingabe von Namen oder Passwörtern»), anschließend mit der **Taste 26 «Plus»**  das Symbol  auswählen und mittels **Taste (25)**  bestätigen.
 - In der **Funktionsanzeige (27)** ausgewähltes Symbol «Speichern»  mittels **Taste (25)**  bestätigen. Das Profil wurde erfolgreich gespeichert und ausgewählt.

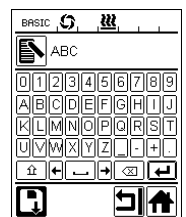
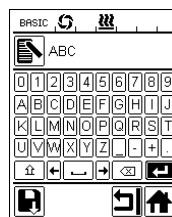
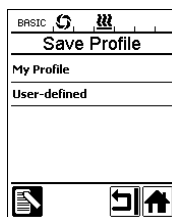
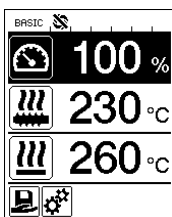

Profile definieren

• Editieren eines bestehenden Profils (ausgenommen Leister-Profile):

- In der **Arbeitsanzeige (28)** gewünschte Sollwerte mittels **Tasten 24/26 «Plus»**  oder **«Minus»**  einstellen.
- In der **Funktionsanzeige (27)** mit **Taste 26 «Plus»**  das Menü **Einstellungen**  auswählen.
- Im Menü «Setup» die Auswahl mit **Taste 26 «Plus»**  «Save Profile» auswählen.
- Das zu editierende Profil auswählen und mittels **Taste (25)**  bestätigen.
- In der **Funktionsanzeige (27)** das Symbol  «Ausgewählte Position bearbeiten» auswählen und mittels **Taste (25)**  bestätigen.
- Gewünschter Profilename eingeben (siehe Kapitel Eingabe von Name oder Passwörter), anschließend mit **Taste 26 «Plus»**  das Symbol  auswählen und mittels **Taste (25)**  bestätigen.
- In der **Funktionsanzeige (27)** ausgewähltes Symbol «Speichern»  mittels **Taste (25)**  bestätigen. Das Profil wurde erfolgreich gespeichert und ausgewählt.

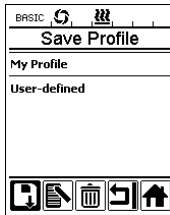
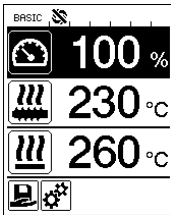



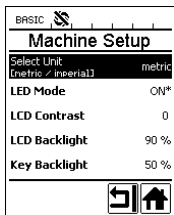

Maschinen-Einstellungen



Menü	Funktion
Select Unit	Einstellung der verwendeten Einheit: – metrisch / imperial
LED Mode	<p>LED Modus:</p> <ul style="list-style-type: none"> – ON*: Die LED-Beleuchtung kann nur eingeschaltet werden, wenn der Antrieb freigegeben ist. Sobald der Antrieb freigegeben ist, erscheint in der Funktionsanzeige (27) das LED-Symbol . Über dieses kann die LED-Beleuchtung nach Wunsch ein- / ausgeschaltet werden. Der LED-Modus wird nicht verändert. – ON: Die LED-Beleuchtung ist immer eingeschaltet. In der Funktionsanzeige (27) wird das LED-Symbol  eingeblendet. Über dieses kann die LED nach Wunsch ein- / ausgeschaltet werden. Der LED-Modus wird nicht verändert. – OFF: Die LED-Beleuchtung ist immer ausgeschaltet.
LCD Contrast	Einstellen des LCD-Kontrastes
LCD Backlight	Einstellen der Display-Hintergrundbeleuchtung
Key Backlight	Einstellen der Tastatur-Hintergrundbeleuchtung

Warnung und Fehlermeldungen

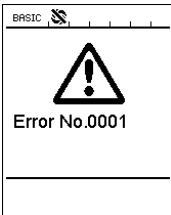
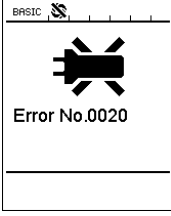
- Liegt eine Warnung vor, kann der Anwender ohne Einschränkung weiter arbeiten. Genauere Informationen zur Warnung können über die **Funktionsanzeige (27)** im Menü Einstellungen  unter «Show Warnings» abgerufen werden.
- Tritt ein Fehler auf, schaltet das Gerät alle Heizungen aus und der Antrieb wird nicht mehr freigegeben.

Art der Meldung	Anzeige	Fehler-Code	Fehlerbeschreibung
Warnung		—	Warnsymbol  in der Statusanzeige (30) . Die Kohlenbürsten des Antriebs müssen gewechselt werden. Nach dem ersten Erscheinen des Warnsymbols kann der Antrieb noch für 5h betrieben werden. Anschliessend erscheint die Fehlermeldung « Error No.0400 » und der Antrieb wird nicht mehr freigegeben.
Fehler		0001	Übertemperatur des Gerätes. Gerät abkühlen lassen.
		0020	Heizelement für Luft defekt.
Fehler! Leister Service Center kontaktieren		0004	Fehler der Hardware.
		0008	Thermoelement der Luft defekt.
		0010	Thermoelement des Plast defekt.
		0040	Heizelement des Plast defekt.
		0100	Gebälse defekt.
		0200	Fehler Kommunikation.
		0400	Kohlenbürsten / Antrieb oder Übertemperatur Antrieb.

Wechsel von Zubehör



Verbrennungsgefahr!



Nur mit temperaturfesten Handschuhen arbeiten.

Wechsel des Schweisschuhs

• Demontage

- Das betriebswarme Gerät abschalten und vom elektrischen Netz trennen.
- Den **Schweissschuh (8)** durch Lösen der **Klemmschrauben (18)** von der **Extrudierdüse (17)** entfernen.
- Die **Extrudierdüse (17)** bei jedem Schweissschuhwechsel von Schweissgutrückständen reinigen und sicherstellen, dass sie festgeschraubt ist.

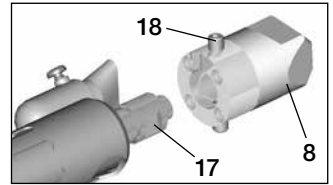

• Montage

- Einen der Schweissnaht angepassten **Schweissschuh (8)** auf die **Extrudierdüse (17)** schieben und durch Anziehen der **Klemmschrauben (18)** befestigen.

Wechsel der Heissluftführung

• Demontage

- **Klemmschraube (33)** lösen. **Heissluftführung (16)** kann abgezogen oder in die gewünschte Schweissrichtung gedreht werden.
- Entsprechende **Heissluftführung (16)** montieren (siehe Kapitel Schweissrichtung).
- **Klemmschraube (33)** festziehen.

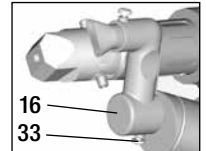

Wechsel der Vorwärmdüse

• Demontage

- Bei der **Vorwärmdüse (9)** die **Klemmschraube (19)** lösen und **Vorwärmdüse (9)** von der **Heissluftführung (16)** abziehen.

• Montage

- **Vorwärmdüse (9)** auf die **Heissluftführung (16)** schieben. Auf parallele Ausrichtung zum **Schweissschuh (8)** achten.
- **Klemmschraube (19)** anziehen.

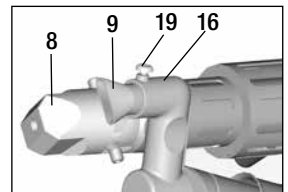

Schweissrichtung

- Für die ausgewählte Schweissrichtung die passende Heissluftführung.

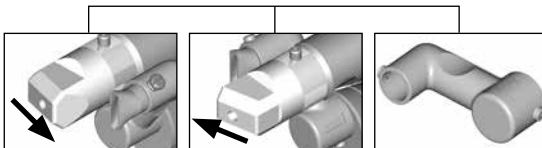

Schweissrichtung

Heissluftführung



Schweissrichtung

Heissluftführung

Zubehör

- Aus technischen und sicherheitsrelevanten Gründen darf ausschliesslich nur Leister-Zubehör verwendet werden.
- Zubehör unter www.leister.com

Schweissschuh-Sortiment

- Leister Technologies AG bietet für alle gebräuchlichen Nahtformen entsprechende Schweisssschuhe in diversen Grössen an:

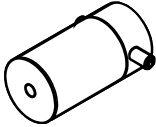

Rohling

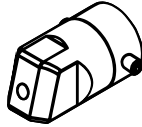

Kehlnaht

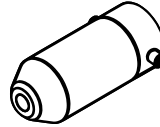

Ecknaht

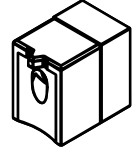







V-Naht

Heissluftführung



Vorwärmdüse

- Damit bei der grossen Auswahl an Schweisssschuhen eine optimale Vorwärmung erreicht wird, bietet Leister Technologies AG verschiedene Vorwärmdüsen an.

Schweisssschuh	Schweissnahtbreite mm	Vorwärmdüsen			
		 Breite 21 mm Länge 26 mm	 Breite 21 mm Länge 42 mm	 ∅ 14 mm Länge 58 mm abgewinkelt	 ∅ 14 mm Länge 46 mm
 Kehlnaht	5 / 6			• (b)	•
	8 / 10			• (b)	•
	12			• (b)	•
 Ecknaht				• (b)	•
 V-Naht	3 / 4	•	• (a)		
	5 / 6	•	• (a)		
	8 / 10	•	• (a)		

a) DVS-Schweisssschuhe analog WELDPLAST S2-PVC.

b) Abgewinkelte Vorwärmdüse für optimale Vorwärmung bei radialen Rohrschweissungen.

Wartung

- **Netzanschlussleitung (13)** und Stecker auf elektrische und mechanische Beschädigungen überprüfen.
- Die **Extrudierdüse (17)** bei jedem Schweißschuhwechsel von Schweißgutrückständen befreien.

Service und Reparatur

- Reparaturen sind ausschliesslich von autorisierten **Leister-Service-Stellen** ausführen zu lassen. Diese gewährleisten innert 24 Stunden einen fachgerechten und zuverlässigen **Reparatur-Service** mit Original-Ersatzteilen gemäss Schaltplänen und Ersatzteillisten.
- Erscheint beim WELDPLAST S1 nach dem Einschalten des Gerätes die Anzeige «Maintenance servicing», sollte der Antriebsmotor (Kollektor und Kohlenbürsten) von einer autorisierten **Leister-Service-Stelle** kontrolliert und allenfalls ersetzt werden. Die Anzeige verschwindet automatisch nach 10 Sekunden oder kann durch Drücken der **Taste (25)**  «**Bestätigen**» direkt übersprungen werden.

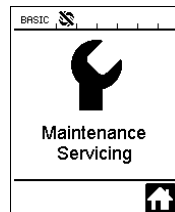

Gewährleistung

- Für dieses Gerät gelten die vom direkten Vertriebspartner/Verkäufer gewährten Garantie- oder Gewährleistungsrechte ab Kaufdatum. Bei einem Garantie- oder Gewährleistungsanspruch (Nachweis durch Rechnung oder Lieferschein) werden Herstellungs- oder Verarbeitungsfehler vom Vertriebspartner durch Ersatzlieferung oder Reparatur beseitigt. Heizelemente sind von der Gewährleistung oder Garantie ausgeschlossen.
- Weitere Garantie- oder Gewährleistungsansprüche werden im Rahmen des zwingenden Rechts ausgeschlossen.
- Schäden, die auf natürliche Abnutzung, Überlastung oder unsachgemässe Behandlung zurückzuführen sind, werden von der Gewährleistung ausgeschlossen.
- Keine Garantie- oder Gewährleistungsansprüche bestehen bei Geräten, die vom Käufer umgebaut oder verändert wurden.



Read the operating instructions carefully before starting the device and keep them for future reference.

Leister WELDPLAST S1 Extrusion Welder

Application

- Extrusion welding of the following materials:
PP / PE-HD / PVC-U / PVC-C / PVDF
- Other materials on enquiry



Warning



Opening the device is **extremely dangerous**, since live parts and connections are exposed. Remove the plug from the socket before opening the device.



Danger of fire and explosion if the extrusion welder is used incorrectly (e.g. overheating of material), particularly near combustible materials and explosive gases.



Danger – can cause burns! Do not touch bare metal parts and emerging material while hot. Allow the device to cool. Do not direct stream of hot air or emerging material towards people or animals.



Connect device to **power socket with protective earth conductor**. Any break in the protective earth conductor inside or outside the device is dangerous!
Only use extension cables with a protective earth conductor!



Caution



The **nominal voltage** indicated on the device must correspond to the mains voltage. If power failure occurs, the main switch and drive must be switched off (release locking device).



When using the device on building sites, a **residual current circuit breaker** is **essential for the safety** of persons there.



Risk of dazzling! Avoid direct eye contact with the LED light beam.
The device must **not be left unattended** when in use. Heat can reach combustible materials which are out of sight.
The device may only be used by **trained personnel** or under their supervision. Children may not use the device under any circumstances.



Keep away from wet and damp areas.

Conformity

Leister Technologies AG, Galileo-Strasse 10, CH-6056 Kaegiswil/Switzerland confirms that this product in the version put into circulation by us, fulfils the requirements of the following EC directives.

Directives:	2006/42, 2004/108 (until 19.04.2016), 2014/30 (starting 20.04.2016), 2006/95 (until 19.04.2016), 2014/35 (starting 20.04.2016), 2011/65
Harmonised standards:	EN 12100, EN 55014-1, EN 55014-2, EN 61000-6-2, EN 61000-3-2, EN 61000-3-3, EN 62233, EN 60335-1, EN 60335-2-45, EN 50581

Kaegiswil, 04.02.2016

Bruno von Wyl
Bruno von Wyl, CTO

Kathrine G.
Andreas Kathriner, GM

Disposal



Electrical equipment, accessories and packaging should be recycled in an environmentally friendly way. **For EU countries only:** Do not dispose of electrical equipment with household refuse!

Technical Data

Voltage	V~	100	120	230
Power consumption	W	1500	1800	1600
Frequency	Hz	50/60	50/60	50/60
Air temperature	°C	max. 360		
Plasticizing temperature	°C	max. 260		
Output (Ø 3 mm)	kg/h	HD-PE 0.2–0.5; PP 0.2–0.5		
Output (Ø 4 mm)	kg/h	HD-PE 0.3–0.8; PP 0.3–0.75		
Filler rod	mm	Ø 3 / Ø 4		
Emission level	L _{pA} (dB)	76 (K = 3 dB)		
Dimensions L × w × h	mm	435 × 264 × 91 (without welding shoe)		
Weight	kg	4.7 (without power supply cord)		
Conformity mark		CE	CE	CE
Mark of approval				
Protection class I				

The right to make technical changes is reserved

Device Description

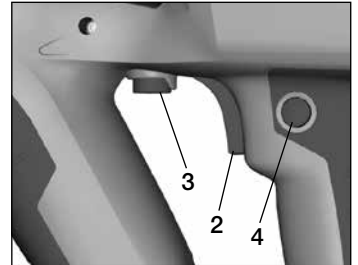
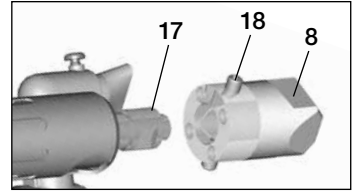
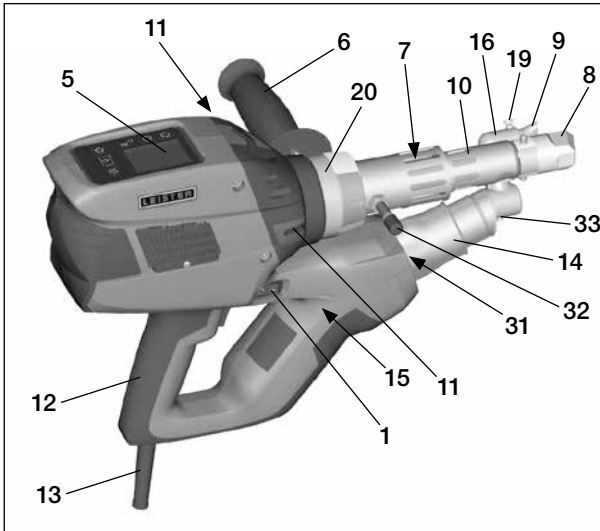

- | | |
|-------------------------------|--------------------------------------|
| 1 Main switch | 13 Power supply cord |
| 2 On/off switch for drive | 14 Heating element protection tube |
| 3 Potentiometer | 15 Blower (brushless) |
| 4 Drive locking device | 16 Hot air duct |
| 5 Display | 17 Extruder nozzle |
| 6 Guide handle | 18 Clamping screw welding shoe |
| 7 Jacket heating | 19 Clamping screw pre-heating nozzle |
| 8 Welding shoe | 20 Gripper clamp |
| 9 Pre-heating nozzle | 31 LED light |
| 10 Protection tube | 32 Buffer bolt |
| 11 Filler rod insertion point | 33 Clamping screw hot air guidance |
| 12 Device grip | |

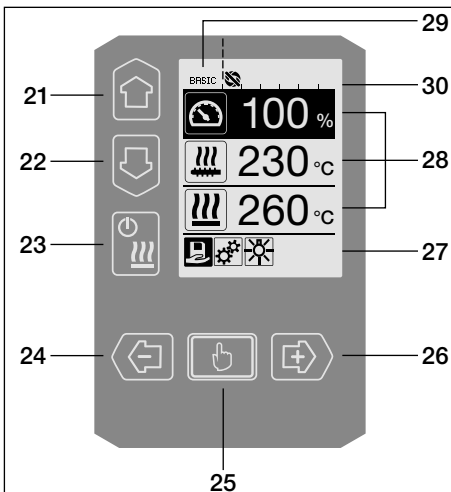









Operating unit

- 21 Key «Up»
- 22 Key «Down»
- 23 Key heating «on/off»
- 24 Key «Minus»
- 25 Key «Confirmed»
- 26 Key «Plus»

Display





- 27 Function display
- 28 Working display
- 29 Status display «Section 1»
- 30 Status display «Section 2»

Operating unit description

Keyboard mode		Current selection in the working display	Current selection in the function display
 	Up (21) Down (22)	Changes the item within the working display	Changes from the function display to the working display
	Heating on/off (23)	No function	Changes from welding mode to the cooling process Changes from the cooling process to welding mode Changes from the start display to welding mode
 	Minus (24) Plus (26) (press briefly)	Sets the required setpoint in 5°C or 5% stages.	Changes the item in the function display
 	Minus (24) Plus (26) (press and hold)	Sets the required setpoint in 10°C or 10% stages.	Changes the item in the function display
	Confirmed (25)	Set value is adopted straight away and the selection goes straight back to the function display	Selected function is executed











Display description













Status display «Section 1» (29)	
PE-HD	Profile currently selected. If profile names consist of more than 6 characters, the first 6 characters are shown first, followed by the remaining characters.
1m16s	Time remaining until the drive is released (1 min. 16 sec.)

Status display «Section 2» (30)	
	Drive released
	Drive not released
	Warning (carbon brushes / drive)
	Key lock (only appears when key lock is activated)
	Air and plasticizing heating is switched on

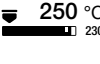
Function and working display

- On the function and operating display, the field or icon that is highlighted always indicates what is currently selected.
- The actual values are always shown in the working display, unless an item is selected, in which case the setpoint is displayed.
- If «Show Set Values» is activated, both the actual value and the setpoint are displayed (small font size).

Function display (27)	
	Select freely definable and predefined profiles
	Settings
	Return to working display (exits a menu directly)
	Switch LED on/off. This function is only available if the LED has been activated.
	Go back one level
	Reset settings or hour counter
	Service menu (can only be accessed by entering the password)
	Save
	Delete the selected item
	Edit the selected item
	Start cooling process

Function display (28)	
	Setpoint: Drive output volume [%]
	Setpoint: Plasticizing temperature [°C/°F]
	Setpoint: Air temperature [°C/°F]
	Setpoint: Air volume [%]
	Information box
	The arrow pointing upward and the progress bar indicate that the setpoint (shown on the progress bar) has not yet been reached (too cold). The flashing value is the actual value. The value next to the progress bar is the setpoint.
	The arrow pointing downward and the progress bar indicate that the setpoint (shown on the progress bar) has not yet been reached (too hot). The flashing value is the actual value. The value next to the progress bar is the setpoint.
	If « Show Set Values » is activated, both the actual temperature (large font size) and the set temperature (small font size) are displayed.
	Cooling process
	Device in standby mode. Once the counter has counted down, the device will start « Cool down mode ».
	An error has occurred. An error code also appears (the device is no longer ready for use). Contact an authorized service center.
	Heating element air faulty
	Device temperature too high. Allow the device to cool down.

Working display overview



Startup display

Display on startup with the software release of the output unit.



Cool down mode

In this mode, the heating is switched off and the device is in cool down mode. If the pre-heating air temperature is more than 100°C when the device is switched on, the device switches automatically to «Cool down mode». The cooling process is complete when the pre-heating air temperature has been below 100°C for 2 mins.

To switch the heating back on again, press the «Heating on/off» key (23)  or the «Confirmed» key (25) .

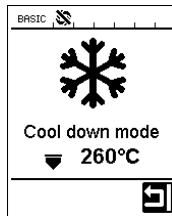

Maintenance servicing

When the maintenance interval for the drive motor is reached, «Maintenance Servicing» appears after the startup display. You can carry on working by pressing the «Confirmed» key (25) . You must take the device to your service center.

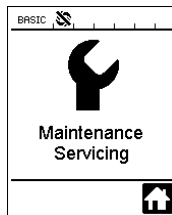

Start display

The start display shows all setpoints.
At this point, the heating is not switched on but you can set all setpoints.

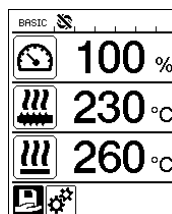

Welding startup display

Display during the heating process

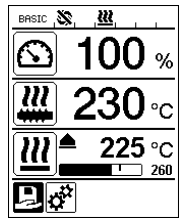

Select Profile

Select a user-defined profile or one defined by Leister. The process of selecting a profile is described in detail in the «Select Profile» chapter on page 32.

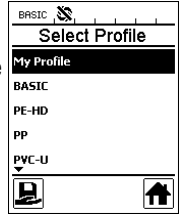

Setup

In the basic setting, you can save profiles and access the standby function via the «Setup» menu.

Select «Advanced Mode» to access a range of other settings options.

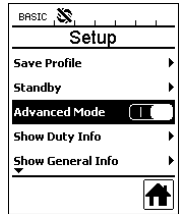
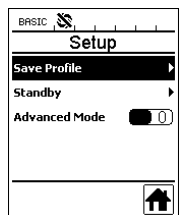

Save profile

The process of saving freely definable profiles is described in detail in the «Defining profiles» chapter on page 34/35.

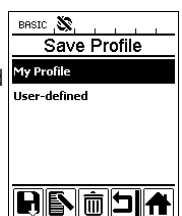

Working display overview

Standby

If standby mode is activated and the user does not press a key on the operating unit or the **on/off switch for drive (2)** during the time set as the **«Standby Interval»**, the device automatically switches to the standby display. If the user does not press the **«Confirmed» key (25)** in the next 180 seconds, cool down mode starts automatically.

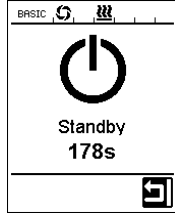
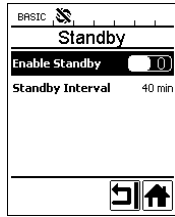

Duty Info

Hours Drive: Current runtime of the drive (can be reset).
 Hours Blower: Current runtime of the blower.
 Hours Machine: Current runtime of the machine.

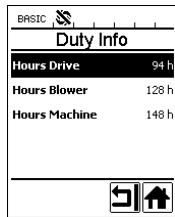

General Info

Firmware HMI: Software version of the display unit (communication module).
 Firmware Machine: Software version of the output unit.
 Production Info: Information about the production date.

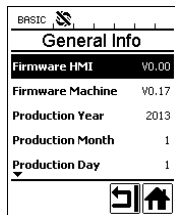

Warnings

If there is a warning pending, this is indicated by the  symbol in the status display. The «Warnings» menu contains more detailed information about the current warning.

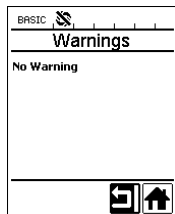

Machine Setup

The machine settings are described in detail in the «Machine Setup» chapter.

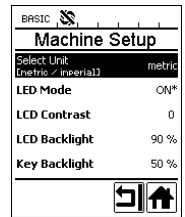

Application Mode

If „Application Mode“ is activated, the operating display will provide detailed information on the actual plasticizing temperature and the capacity utilization of the hot-air blowers and plasticizing heating.



Plast: 80% 222 °C
 Heat: 40% 197 °C
 Amb.: 25 °C
 Mains: 50Hz

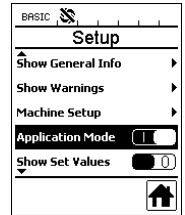

If «Show Set Values» is activated, both the actual temperature (large font size) and the set temperature (small font size) are displayed.

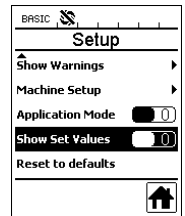

Reset to defaults

If the “Reset to defaults” menu is selected and confirmed by selecting the relevant function , all customer-specific profiles will be deleted. Settings that have been changed via the Setup menu will be reset to the factory settings.

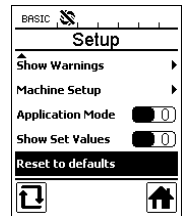

Menu navigation

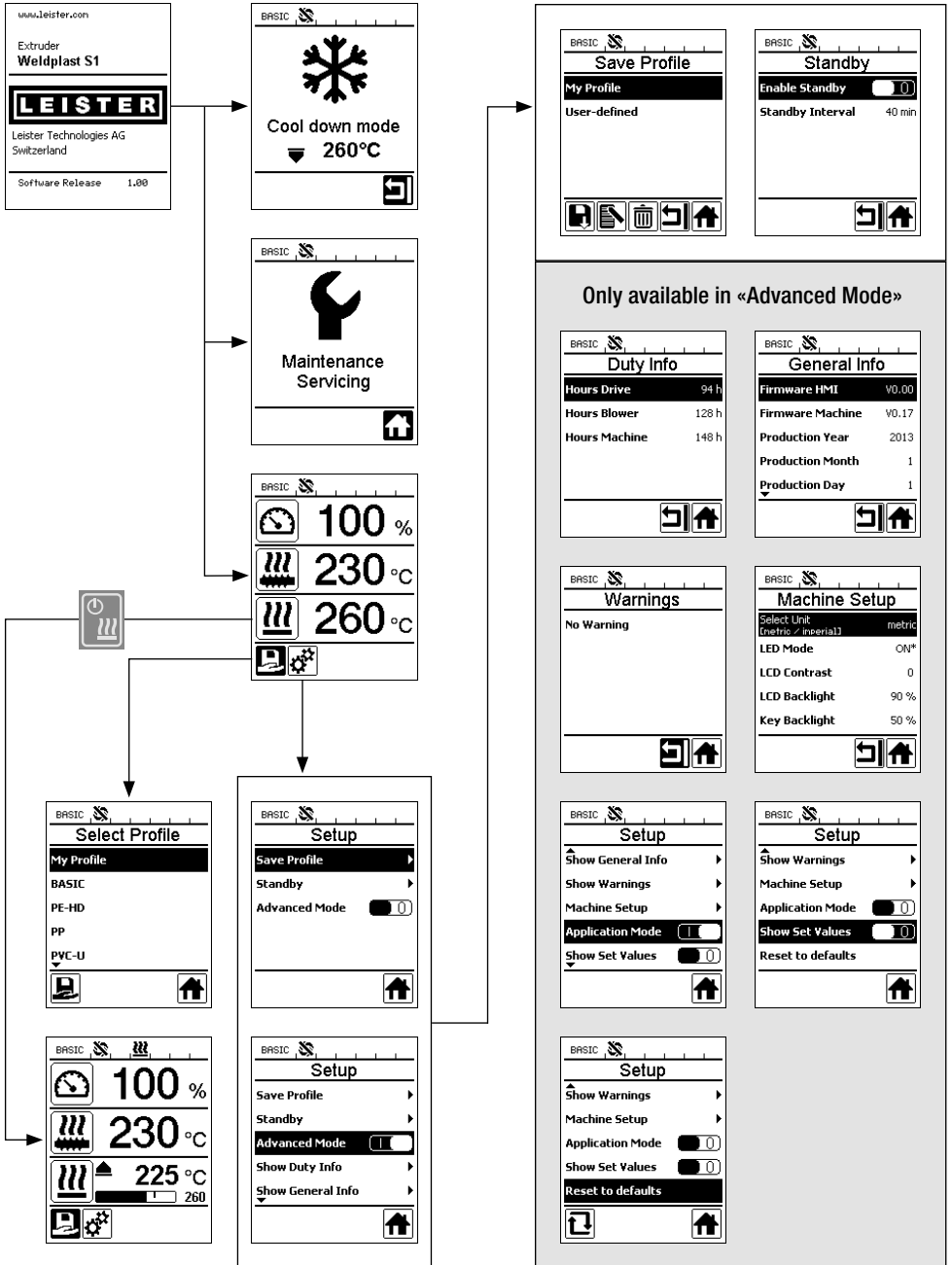

Work environment / Safety



Before putting into operation, check power supply cord (13) and connector as well as extension cable for electrical and mechanical damages.

The extrusion welder must not be used in areas where there is danger of explosion or flammable materials. Ensure a safe posture during work. The power cable and filler rod must be free to move and must not obstruct the user or third parties during work.

Place extrusion welder on a fire resistant base. Hot metal parts and hot streams of air must be kept at a safe distance from the base and walls.

Workplace



Leister provides a stand for commissioning and holding the extrusion welder

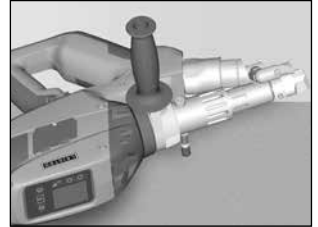

When not welding, the drive should be switched off with the **drive on/off switch (2)**.

Place the extrusion welder with correspondingly set and firmly tightened **guide handle (6)** on a stable, fireproof base or **buffer bolt (32)** as shown in the illustration.

Guide handle

Setting the guide handle

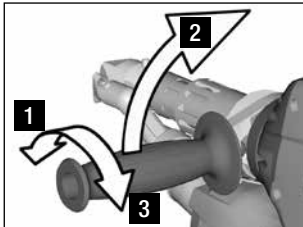

- 1** Loosen clamp by turning the **guide handle (6)** anti-clockwise
- 2** Move the **guide handle (6)** into the desired operating position.
- 3** Tighten clamp again by turning **guide handle (6)** clockwise

Removing/Fitting the handle

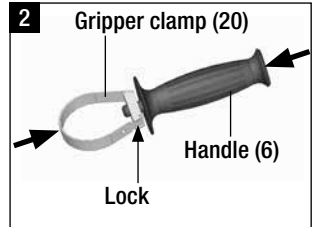
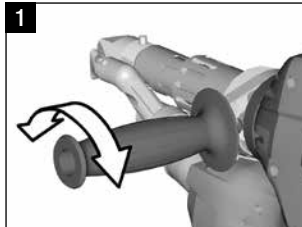

Risk of burning! Let the device cool

Removing the handle

- 1** Turn the **handle (6)** anticlockwise to loosen the clamp.
- 2** Press on the **handle (6)** and the **gripper clamp (20)** to open the lock (see arrows). Remove the **handle (6)** using the **gripper clamp (20)**.

To fit the handle, follow the steps in reverse order.

Extension cables

- Ensure the minimum cross-section when using extension cables:
- The extension cable must be approved for the site of use (e.g. in the open air) and marked correspondingly.
- When using a power unit for power supply, its nominal power rating is: $2 \times$ nominal power rating of the extrusion welder.

Length [m]	Minimum cross-section (at 100 – 230V~) [mm ²]
Up to 19	2.5
20 – 50	4.0

Starting the device

- Install the relevant **welding shoe (8)**, **pre-heating nozzle (9)**, and **hot air duct (16)** if necessary (Changing accessories, page 37).



Connect the device to the nominal voltage. The nominal voltage specified on the device must match the mains voltage.

- Switch the extruder on at the **main switch (1)**. Depending on the pre-heating air temperature, either the startup display or «Cool down mode» will appear on the **display (5)**. Press the «**Heating on/off**» **key (23)**  to start the heating process.
- If the device is ready for operation, the **LED light (31)** will switch on automatically (factory setting).
- Press the **on/off switch for drive (2)** to start the drive.

Welding process

- Insert the filler rod (\varnothing 3 or 4 mm) into the **filler rod insertion point (11)**.
- The filler rod is automatically drawn through the **filler rod insertion point (11)**. There must be no resistance when the rod is inserted.



CAUTION!

Always operate the device with the filler rod, but never feed the filler rod into both filler rod insertion points at the same time.

- The speed at which the filler rod is drawn in can be set using the **potentiometer (3)**.
- Pause the delivery of material using the **on/off switch for drive (2)**.
- Direct the **pre-heating nozzle (9)** onto the area to be welded.
- Pre-heat the area to be welded with oscillating movements.
- Place the device on the prepared welding area and press the **on/off switch for drive (2)** again.
- Carry out a test weld according to the welding instructions from the material manufacturer and the national standards or directives. Check the test weld.
- Adjust the temperature setting, output volume, and air volume as necessary (see "Setting the welding parameters" chapter, page 31).
- During a longer period of welding, the **on/off switch for drive (2)** can be kept in continuous operation using the **drive locking device (4)**.

CAUTION!

- PVC-U and PVC-C are processed in the menu of PVC-U.
- To prevent corrosion when processing PVC-U, PVC-C, ECTFE, PVDF etc., we recommend flushing the extrusion welder with HD-PE when you have finished welding.





Switching off the device

- Loosen the **drive locking device (4)** and **release the on/off switch for drive (2)**.
- Remove the **welding material** from the welding shoe (8).
- Press the **«Heating on/off»** key (23)  and the **«Confirmed»** key (25) to switch the heating off and start «Cool down mode».
- After the cooling process, the blower will switch off automatically and the start display appears on the **display (5)**.
- **Switch off** the main switch (1).



Disconnect the power cord from the mains.

Setting a parameter

- If a setpoint value (such as the setpoint plasticizing temperature) needs to be changed, pressing **keys 21/22**, „Up“  or „Down“ , allows the relevant setpoint to be selected.
- As long as the setpoint is highlighted, it can be changed using **keys 24/26**, „Plus“  or „Minus“ . In the case of the WELDPLAST S1, four setpoints can be set:



Output volume (max. output when potentiometer is at level 5)



Plasticizing temperature





Air temperature

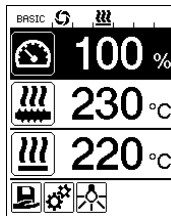

Air volume

- A maximum of three elements can be shown in the working display.



- You can access other elements by pressing the **«Up»** or  **«Down»**  keys (21/22).

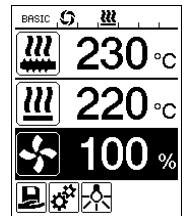



- During extrusion, you can adjust the output volume in 5% stages directly using the **potentiometer (3)**. The output volume ranges from min. 35% to the max. set value. The value currently set is always visible in the working display.
- The value set in the working display is taken to be the maximum value. You cannot set the output volume to more than this set maximum value with the **potentiometer (3)**. The maximum value is, therefore, typically set to 100%.
- If the output volume is too large with the minimum output (35%), you must change to a filler rod thickness of 3mm.
- If the output volume is too small with the maximum output (100%), you must change to a filler rod thickness of 4mm.

Select Profile

- Selection of a predefined or freely definable profile
- The WELDPLAST S1 has six predefined Leister profiles and up to ten profiles that can be freely defined:

Welding profiles		Max. output [%]	Set plasticizing temperature [°C/°F]	Set air temperature [°C/°F]	Air volume [%]
1	BASIC	adjustable	adjustable	adjustable	adjustable
2	PE-HD	100	230	260	100
3	PP	100	240	260	100
4	PVC-U	100	200	300	100
5	PVDF	100	250	320	100
6 – 16	Freely definable profiles	adjustable	adjustable	adjustable	adjustable

- Selecting the icon  on the **function display (27)** takes you to the „Select Profile“ menu. One of these six predefined profiles (1 – 6) or a customer-specific freely definable profile (7 – 16) can be selected using **keys 21/22**, „Up“  and „Down“ .
- If setpoints (profiles 2 – 16) are changed during operation, they will not be saved in the profile.
- Every time the machine is switched on/off, the values defined in the profile will reappear.
- If you would like to use the last set values when you switch on the machine again, you must select the BASIC (1) profile.
- The currently selected profile can be seen on the left in the **status display «Section 1» (29)**.

PE-HD 

Monitoring the welding parameters

- The current plasticizing temperature and air temperature are monitored constantly. If an actual value deviates from the corresponding setpoint, this is displayed in the **working display (28)** («Show Set Values» not activated).

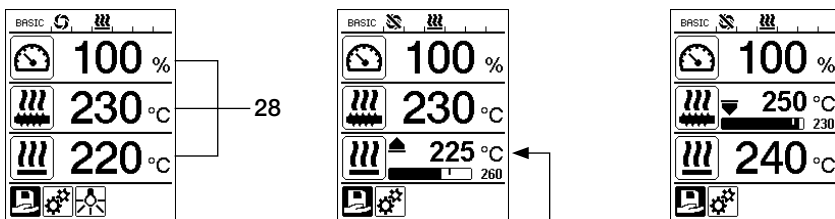

- Actual value corresponds to the setpoint.
- Actual value for air temperature too low.
Heating process flashes (arrow pointing upward and progress bar).
- Actual value for plasticizing temperature too high.
Cooling process flashes (arrow pointing downward and progress bar).

Drive release

- There are four different waiting times for the drive release (see table). These times depend on the actual plasticizing temperature and the set plasticizing temperature. The pre-heating air does not affect the drive release.
- The release zone begins as soon as the actual plasticizing temperature is higher than the set temperature – 20 K.
- **Corresponding symbol in the status display:**



Drive is not released





Drive released

Actual plasticizing temperature when the heating is switched on or when the set plasticizing temperature is adjusted	Set plasticizing temperature	Release time once the release zone is reached
Set plasticizing temperature – 5K < actual plasticizing temperature	—	Drive is released immediately
Set plasticizing temperature – 20K < actual plasticizing temperature < set plasticizing temperature – 5K	—	30 sec.
Set plasticizing temperature – 20K > actual plasticizing temperature (below the release zone)	> 190°C	2 min. 30 sec.
Set plasticizing temperature – 20K > actual plasticizing temperature (below the release zone)	< 195°C	3 min. 30 sec.

- If the WELDPLAST S1 cannot keep the actual plasticizing temperature in the release zone for more than 10 seconds when the drive is released, it will be locked again. As soon as the device reaches the release zone again and the time defined in the table has elapsed, the drive is released again.

Key lock





- Press and hold the «Up»  and «Down» keys (21/22)  at the same time for at least two seconds to activate or deactivate the key lock.







Power supply interruption

Drive state before power supply interruption	Duration of power supply interruption	WELDPLAST S1 state after power supply interruption
Drive released Welding working display	≤ 5 sec	The device starts up without restart protection and switches straight to the state it was in before the power supply was interrupted
Drive released (pre-heating air > 100°C)	> 5 sec	The device switches straight to «Cool down mode»
Drive released (pre-heating air < 100°C)	> 5 sec	The device starts up and the start display appears on the display (5) .













Entering names or passwords

- In keyboard mode, you can define names or enter passwords with a maximum of 12 characters.

Keyboard mode	Character selection 34	Symbol selection 35
 	Up (21) Down (22)	Vertical character selection
 	Minus (24) Plus (26)	Horizontal character selection Symbol selection
	Confirmed (25)	Confirm the selected character Confirm the selected symbol

		Change between upper and lower case
	 	Move the cursor in the name
		Insert blank space
		Delete one character (the character to the left of the cursor)
		Select this symbol to switch to the function display 27





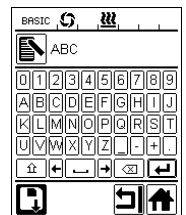
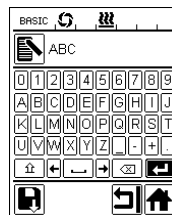
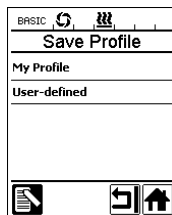
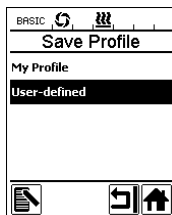
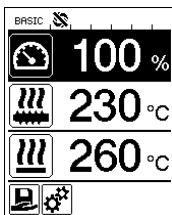







Defining profiles

- In the «Save Profile» menu, you can save setpoint settings for the max. output volume, the plasticizing/air temperature, and the air output and give the profile a name (see «Entering names or passwords» chapter).
- Creating a new profile:**
 - In the **working display (28)**, set the required setpoints using the **«Plus»**  or **«Minus»**  keys (24/26).
 - In the **function display (27)**, select the Settings menu  with the **«Plus» key (26)** .
 - In the «Setup» menu, select «Save Profile» with the **«Plus» key (26)** .
 - Select the «User-defined» profile and confirm with the relevant **key (25)** .
 - In the **function display (27)**, select the «Edit selected item» symbol  and confirm with **the relevant key (25)** .
 - Enter the desired profile name (see "Entering names or passwords" chapter), then select the  symbol with the **«Plus» key (26)**  and **confirm with the relevant key (25)** .
 - In the **function display (27)**, confirm the selected «Save» symbol  with the relevant **key (25)** . The profile has now been successfully saved and selected.



Defining profiles

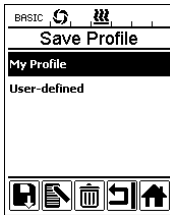
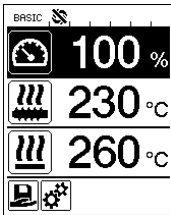

• Editing an existing profile (excluding Leister profiles):

- In the **working display (28)**, set the required setpoints using the «Plus»  or «Minus»  keys (24/26).
- In the **function display (27)**, select the Settings menu  with the «Plus» key (26) .
- In the «Setup» menu, select «Save Profile» with the «Plus» key (26) .
- Select the profile you want to edit and confirm with the relevant **key (25)** .
- In the **function display (27)**, select the «Edit selected item» symbol  and confirm with the relevant **key (25)** .
- Enter the desired profile name (see "Entering names or passwords" chapter), then select the  symbol with the «Plus» key (26)  and **confirm with the relevant key (25)** .
- In the **function display (27)**, confirm the selected «Save» symbol  with the relevant **key (25)** . The profile has now been successfully saved and selected.



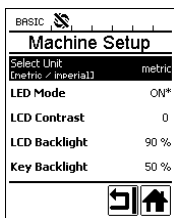



Machine setup



Menu	Function
Select Unit	Setting the unit used: – metric/imperial
LED Mode	<p>LED mode:</p> <ul style="list-style-type: none"> – ON*: The LED light can only be switched on if the drive is released. As soon as the drive is released, the LED symbol  appears in the function display (27). This symbol allows you to switch the LED light on/off as you wish. The LED mode is not changed. – ON: The LED light is permanently switched on. The LED symbol  is displayed in the function display (27). This symbol allows you to switch the LED on/off as you wish. The LED mode is not changed. – OFF: The LED light is permanently switched off.
LCD Contrast	Setting the LCD contrast
LCD Backlight	Setting the backlight for the display
Key Backlight	Setting the backlight for the keyboard

Warnings and error messages

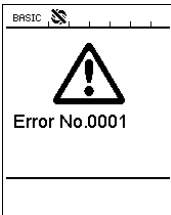
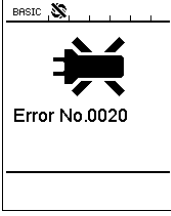
- If there is a warning pending, the user can continue to work without restrictions. You can access more detailed information about the warning in question via the **function display (27)** by selecting «Show Warnings» in the Settings menu .
- If an error occurs, the heating is switched off and the drive is no longer released.

Message type	Display	Error code	Error description
Warning		—	Warning symbol  in the status display (30) . The carbon brushes in the drive needs to be replaced. The drive can continue to be operated for 5 hours after the warning symbol first appears. After this time, the error message « Error No.0400 » appears. From this point, the drive is no longer released.
Error		0001	Device has overheated. Allow the device to cool down.
		0020	Air heating element is faulty.
Error! Contact Leister service center.		0004	Hardware error.
		0008	Air thermocouple is faulty.
		0010	Plast thermocouple is faulty.
		0040	Plast heating element is faulty.
		0100	Blower is faulty.
		0200	Communication error.
		0400	Drive carbon brushes or overheated drive.

Replacing accessories



Danger – can cause burns!



Only work with heat-resistant gloves.

Replacing the welding shoe

• Removal

- Switch off the device while warm and disconnect it from the mains.
- Remove the **welding shoe (8)** by unfastening the **clamping screws (18)** from the **extruder nozzle (17)**.
- Every time the welding shoe is changed, clean the **extruder nozzle (17)** of welding residue and make sure that it is screwed in tightly.

• Fitting

- Place a **welding shoe (8)**, adapted to the welding seam, onto the **extruder nozzle (17)** and tighten the **clamping screws (18)** to secure it in place.

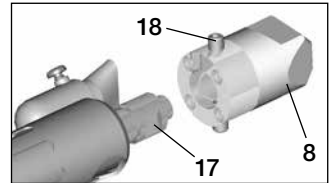

Replacing the hot air duct

• Removal

- Loosen **the clamping screw (33)**. **The hot air duct (16)** can now be removed or rotated in the required welding direction.
- Fit the appropriate **hot air duct (16)** (see "Welding direction" chapter).
- Tighten **the clamping screw (33)**.

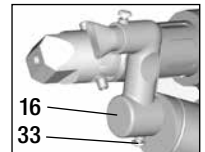

Replacing the pre-heating nozzle

• Removal

- Loosen **the clamping screw (19)** on the **pre-heating nozzle (9)** and remove the **pre-heating nozzle (9)** from the **hot air duct (16)**.

• Fitting

- Place the **pre-heating nozzle (9)** onto the **hot air duct (16)**. Make sure that it is parallel to the **welding shoe (8)**.
- Tighten **the clamping screw (19)**.

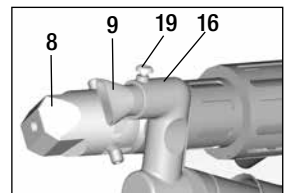

Welding direction

- Choose the right hot air duct for the selected welding direction.

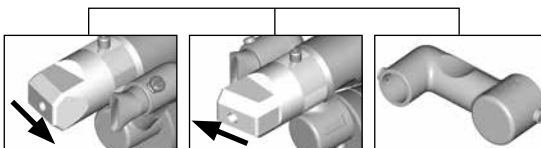

Welding direction

Hot air duct



Welding direction

Hot air duct

Accessories

- Only Leister accessories may be used for technical and safety-related reasons.

Welding shoe range

- Leister Technologies AG offers the right welding shoes for all common types of seam in various sizes:

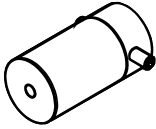

Blank

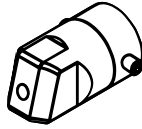

Fillet weld

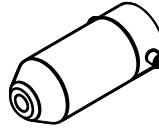

Corner seam

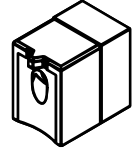







V Seam

Hot air duct



Pre-heating nozzle

- In order to optimize pre-heating for the wide range of welding shoes available, Leister Technologies AG offers various different pre-heating nozzles.

Welding shoe	Welding seam width mm	Pre-heating nozzles			
					
Fillet weld 	5 / 6			• (b)	•
	8 / 10			• (b)	•
	12			• (b)	•
Fillet weld 				• (b)	•
V Seam 	3 / 4	•	• (a)		
	5 / 6	•	• (a)		
	8 / 10	•	• (a)		

a) DVS-Schweisschuhe analog WELDPLAST S2-PVC.

b) Abgewinkelte Vorwärmdüse für optimale Vorwärmung bei radialen Rohrschweißungen.

Maintenance

- Check **power supply cord (13)** and plug for electrical and mechanical damage.
- Clean the **extruder nozzle (17)** of welding residue every time the welding shoe is changed.

Service and Repairs

- Repairs should only be carried out by authorised **Leister service points**. These guarantee a professional, reliable **repair service within 24 hours**, using original replacement parts according to the circuit diagrams and replacement part lists.
- If the display «Maintenance servicing» appears after the WELDPLAST S1 device is switched on, the drive motor (collector and carbon brushes) should be checked by an authorized Leister service center and replaced if necessary. The display disappears automatically after 10 seconds or can be directly skipped by pressing the «**Acknowledge**» **button (25)** .

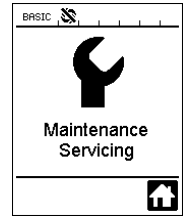

Warranty

- For this tool, the guarantee or warranty rights granted by the relevant distributor/seller shall apply. In case of guarantee or warranty claims any manufacturing or workmanship defects will either be repaired or replaced by the distributor at its discretion. Warranty or guarantee rights have to be verified by an invoice or a delivery document. Heating elements shall be excluded from warranty or guarantee.
- Additional guarantee or warranty claims shall be excluded, subject to mandatory provisions of law.
- Warranty or guarantee shall not apply to defects caused by normal wear and tear, overload or improper handling.
- Warranty or guarantee claims will be rejected for tools that have been altered or changed by the purchaser.



Lisez attentivement la notice d'utilisation avant de mettre l'appareil en service et conservez-la à disposition pour une consultation ultérieure.

Leister WELDPLAST S1 Extrudeuse manuelle

Application

- Soudage par extrusion des matériaux suivants:
PP / PE-HD / PVC-U / PVC-C / PVDF
- Autres matériaux sur demande



Avertissement



Danger de mort à l'ouverture de l'appareil, car des composants et des liaisons sous tension sont découverts. Avant d'ouvrir l'appareil, retirez la fiche secteur de la prise de courant.



Risque d'incendie et d'explosion en cas d'utilisation non conforme de l'extrudeuse manuelle (par exemple en cas de surchauffe du matériau), en particulier à proximité de matériaux inflammables et de gaz explosifs.



Risque de brûlure! Ne touchez pas les pièces métalliques nues et la masse extrudée si elles sont chaudes. Laissez refroidir l'appareil. Ne dirigez pas le jet d'air chaud ni la masse extrudée sur les personnes ou les animaux.



Raccordez l'appareil à une prise de courant équipée d'un **conducteur de protection**. Toute rupture du conducteur de protection à l'intérieur ou à l'extérieur de l'appareil est dangereuse!

Utilisez exclusivement un câble de prolongation équipé d'un conducteur de protection!



Attention



La **tension nominale** indiquée sur l'appareil doit correspondre à la tension du secteur. En cas de panne de courant, le commutateur principal et l'entraînement doivent être mis hors tension (déblocage du dispositif d'arrêt).



Un **interrupteur FI** est **absolument nécessaire** pendant l'utilisation de l'appareil sur des chantiers pour assurer la protection des personnes.



Risque d'éblouissement! Éviter de regarder directement dans le faisceau de lumière de la LED.

L'appareil doit fonctionner sous **supervision**. La chaleur peut atteindre des matériaux inflammables se trouvant hors de portée de vue. L'appareil doit être utilisé exclusivement par des spécialistes formés ou sous leur supervision. L'utilisation de l'appareil par des enfants est strictement interdite.



Protégez l'appareil de l'humidité et de la pluie.

Conformité

Leister Technologies AG, Galileo-Strasse 10, CH-6056 Kaegiswil/Suisse atteste que ce produit, dans la version que nous avons mise en circulation, satisfait aux exigences des directives CE suivantes.

Directives: 2006/42,
2004/108 (jusqu'au 19.04.2016), 2014/30 (à partir du 20.04.2016),
2006/95 (jusqu'au 19.04.2016), 2014/35 (à partir du 20.04.2016),
2011/65

Normes harmonisées: EN 12100, EN 55014-1, EN 55014-2, EN 61000-6-2, EN 61000-3-2,
EN 61000-3-3, EN 62233, EN 60335-1, EN 60335-2-45, EN 50581

Kaegiswil, 04.02.2016

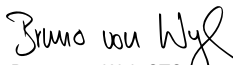
Bruno von Wyl, CTO

Andreas Kathriner, GM

Elimination



Les outils électriques, les accessoires et les emballages doivent être recyclés en respectant l'environnement. **Pour les pays de l'UE uniquement:** ne pas jeter les outils électriques avec les déchets ménagers !

Caractéristiques techniques

Tension	V~	100	120	230
Puissance	W	1500	1800	1600
Fréquence	Hz	50/60	50/60	50/60
Température de l'air	°C	max. 360		
Température de plastification	°C	max. 260		
Débit (Ø 3 mm)	kg/h	HD-PE 0.2–0.5; PP 0.2–0.5		
Débit (Ø 4 mm)	kg/h	HD-PE 0.3–0.8; PP 0.3–0.75		
Cordon de soudure	mm	Ø 3 / Ø 4		
Niveau sonore	L _{pA} (dB)	76 (K = 3 dB)		
Dimensions L × l × h	mm	435 × 264 × 91 (sans patin de soudage)		
Poids	kg	4.7 (sans câble d'alimentation secteur)		
Marque de conformité		CE	CE	CE
Homologation				Ⓢ
Classe de protection I		Ⓛ	Ⓛ	Ⓛ

Sous réserve de modifications techniques

Description de l'appareil

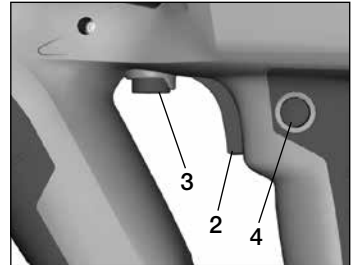
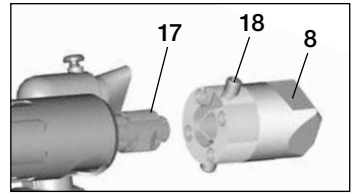
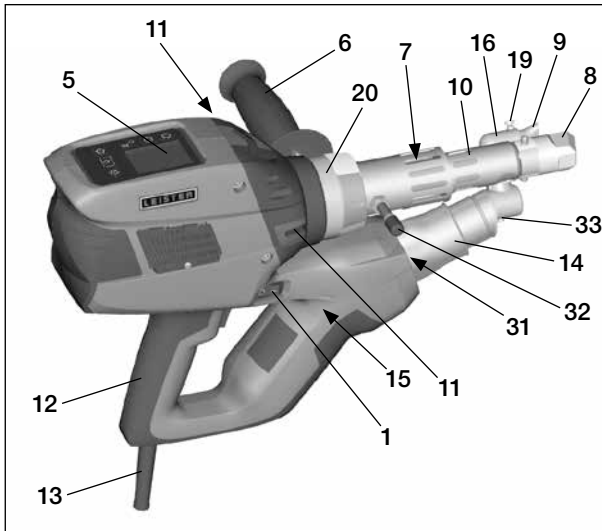

- 1 Commutateur principal
- 2 Interrupteur Marche/Arrêt de l'entraînement
- 3 Potentiomètre
- 4 Dispositif d'arrêt de l'entraînement
- 5 Écran d'affichage
- 6 Poignée
- 7 Chauffage de la chemise
- 8 Patin de soudage
- 9 Buse de préchauffage
- 10 Fourreau de protection
- 11 Orifice d'introduction du cordon de soudure
- 12 Poignée de l'appareil

- 13 Câble d'alimentation secteur
- 14 Fourreau de protection de la résistance
- 15 Soufflerie (sans balai)
- 16 Conduite d'air chaud
- 17 Buse d'extrusion
- 18 Vis de blocage du patin de soudage
- 19 Vis de blocage de la buse de préchauffage
- 20 Collier de serrage
- 31 Éclairage à LED
- 32 Goujon de support
- 33 Vis de blocage de la conduite d'air chaud

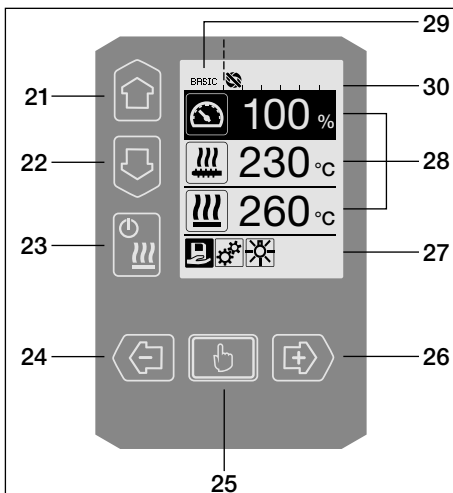









Unité de commande

- 21 Touche «Haut»
- 22 Touche «Bas»
- 23 Touche «Chauffage Marche/Arrêt»
- 24 Touche «Moins»
- 25 Touche «Confirmer»
- 26 Touche «Plus»

Écran d'affichage

- 27 Affichage des fonctions
- 28 Affichage de travail
- 29 Affichage d'état «Zone 1»
- 30 Affichage d'état «Zone 2»

Description de l'unité d'affichage





Mode clavier		Sélection en cours sur l'affichage de travail	Sélection en cours sur l'affichage des fonctions
 	Haut (21) Bas (22)	Modifier la position sur l'affichage de travail	Passage de l'affichage des fonctions à l'affichage de travail
	Chauffage Marche/Arrêt (23)	Sans fonction	Passage du mode de soudage à la phase de refroidissement Passage de la phase de refroidissement au mode de soudage Passage de l'affichage de démarrage au mode de soudage
 	Moins (24) Plus (26) (appuyer brièvement)	Réglage de la valeur de consigne souhaitée par pas de 5°C ou 5 %.	Modification de la position sur l'affichage des fonctions
 	Moins (24) Plus (26) (appuyer et rester appuyé)	Réglage de la valeur de consigne souhaitée par pas de 10°C ou 10 %.	Modification de la position sur l'affichage des fonctions
	Confirmer (25)	La valeur réglée est reprise directement et la sélection revient automatiquement à l'affichage des fonctions	La fonction choisie est exécutée

Description de l'écran d'affichage

Affichage d'état «Zone 1» (29)











PE-HD	Profil actuellement sélectionné. Lorsque le nom du profil a plus de 6 caractères, les 6 premiers caractères sont d'abord affichés, puis les autres.
1m16s	Temps restant jusqu'au déverrouillage de l'entraînement (1 min / 16 s)



Affichage d'état «Zone 2» (30)

	Entraînement déverrouillé
	Entraînement non déverrouillé
	Activation d'un avertissement (charbons/entraînement)
	Verrouillage des touches (n'est affiché que si le verrouillage des touches est activé)
	Le chauffage de l'air et de plastification est en marche

Affichage des fonctions et de travail

- Le champ ou le symbole marqué sur les affichages des fonctions et de travail définit toujours la sélection en cours.
- Les valeurs réelles sont toujours indiquées sur l'affichage de travail, sauf lorsqu'une position est sélectionnée, dans ce cas c'est la valeur de consigne qui est affichée.
- Si la fonction «Show Set Values» (Afficher valeurs prédéfinies) est activée, la valeur réelle et la valeur de consigne (en petit) sont affichées.

Affichage des fonctions (27)	
	Sélectionner les profils libres et prédéfinis
	Réglages
	Retour à l'affichage de travail (quitter directement un menu)
	Allumer/éteindre la LED. Cette fonction n'est disponible que si la LED a été activée.
	Revenir au niveau précédent
	Réinitialiser les réglages ou le compteur d'heures
	Menu Service (accessible uniquement avec mot de passe)
	Enregistrer
	Effacer la position sélectionnée
	Éditer la position sélectionnée
	Lancer la phase de refroidissement

Affichage de travail (28)	
	Valeur de consigne : Débit entraînement [%]
	Valeur de consigne : Température de plastification [°C / °F]
	Valeur de consigne : Température de l'air [°C / °F]
	Valeur de consigne : Débit d'air
	Fenêtre d'informations
	La flèche dirigée vers le haut et la jauge de progression indiquent que la valeur de consigne (repère sur la jauge de progression) n'est pas encore atteinte (trop froid). La valeur qui clignote est la valeur réelle. La valeur inscrite à côté de la jauge de progression représente la valeur de consigne définie.
	La flèche dirigée vers le bas et la jauge de progression indiquent que la valeur de consigne (repère sur la jauge de progression) n'est pas encore atteinte (trop chaud). La valeur qui clignote est la valeur réelle. La valeur inscrite à côté de la jauge de progression représente la valeur de consigne définie.
	Si la fonction « Show Set Values » (Afficher valeurs prédéfinies) est activée, la température réelle (en grand) et la température de consigne (en petit) sont affichées.
	Phase de refroidissement
	Appareil en mode de veille. L'appareil démarrera le mode « Cool down modus » (Mode refroidissement) une fois le décompte du compteur terminé
	Erreur sur l'appareil. Un code d'erreur s'affiche en plus (l'appareil n'est plus prêt à l'emploi). Contacter le centre S.A.V. agréé
	Résistance chauffage de l'air défectueuse
	Température de l'appareil trop élevée. Laisser refroidir l'appareil.

Affichage de lancement

Affichage lors du lancement avec nouvelle version logicielle de l'unité de puissance.



Cool down mode (refroidir)

Les chauffages sont éteints dans ce mode et l'appareil est en mode de refroidissement. Si, lors de la mise en marche de l'appareil, la température de l'air de préchauffage est supérieure à 100 °C, l'appareil passe automatiquement au «Cool down mode» (Mode refroidissement). Cette phase est achevée lorsque la température de l'air de préchauffage est inférieure à 100 °C pendant 2 minutes. Si les chauffages doivent être remis en marche, il faut appuyer sur la **touche (23)**  «**Chauffage Marche/Arrêt**» ou sur la **touche (25)**  «**Confirmer**».

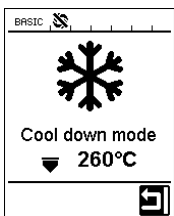

Maintenance servicing (maintenance)

Dès que l'intervalle de maintenance du moteur de l'entraînement est atteint, «Maintenance **Servicing**» (Maintenance) s'affiche après l'affichage de lancement. Il est possible de poursuivre le travail en utilisant la **touche (25)**  «**Confirmer**». L'appareil doit impérativement être porté au centre S.A.V.



Affichage de démarrage

Toutes les valeurs de consigne sont affichées sur l'affichage de démarrage. Le chauffage n'est pas encore en marche, toutes les valeurs de consigne peuvent toutefois déjà être définies.

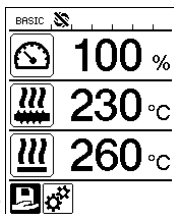

Affichage de lancement du soudage

Affichage pendant la phase de montée en température

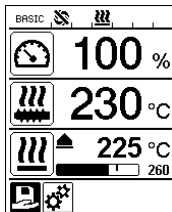

Select Profile (sélectionner un profil)

Sélectionnez un profil que vous avez défini ou un profil prédéfini par Leister. La sélection de profil est décrite au chapitre «Select Profile» (Sélectionner un profil) à la page 51.

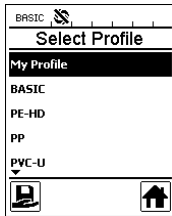

Setup (réglages)

Depuis le réglage de base, vous parvenez à l'enregistrement d'un profil et à la fonction de veille par le menu «**Setup**» (Réglages). Après sélection de «**Advanced Mode**» (Mode avancé), d'autres possibilités de réglage sont disponibles.

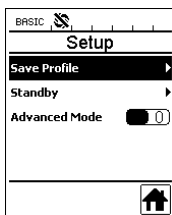

Save profile (définir des profils libres)

L'enregistrement de profil libre est décrite au chapitre «Enregistrer le profil» aux pages 53 / 54.

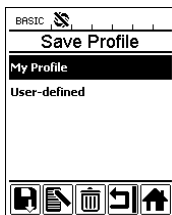

Standby (veille)

Lorsque le mode de veille est activé et que, pendant le temps défini sous «**Standby Interval**» (intervalle de veille), aucune touche de l'unité de commande ni l'interrupteur Marche/Arrêt de l'entraînement (2) ne sont actionnées, l'appareil passe automatiquement à l'affichage du mode de veille. Le mode de refroidissement démarre automatiquement si pendant les 180 secondes qui suivent, la touche (25) «**Confirmer**» n'est pas appuyée.

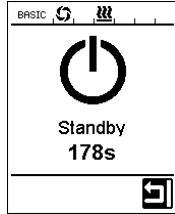
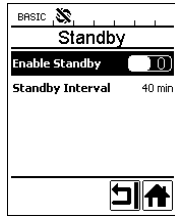

Duty Info

Hours Drive: temps de fonctionnement actuel de l'entraînement (peut être remis à 0).

Hours Blower: temps de fonctionnement actuel de la soufflerie.

Hours Machine: temps de fonctionnement actuel de la machine.

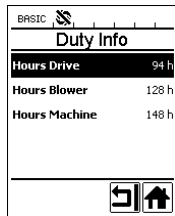

General Info

Firmware HMI: version logicielle de l'unité d'affichage (module de communication).

Firmware Machine: révision logicielle de l'unité de puissance.

Production Info: indications sur le moment de la production.

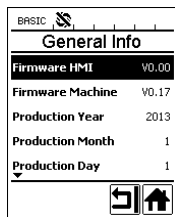

Warnings

Si un avertissement est activé, le symbole  le signale sur l'écran d'affichage d'état. Vous trouverez des informations plus précises sur l'avertissement en cours dans le menu «Warnings» (Avertissements).

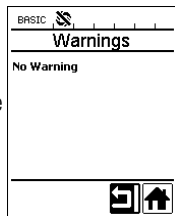

Machine Setup

Les réglages de la machine sont décrits en détail au chapitre «Réglages de la machine».

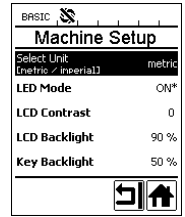

Application Mode

Lorsque la fonction «Application Mode» (Mode d'application) est activée, vous pouvez consulter des indications détaillées sur la température réelle de plastification et sur la charge de la soufflerie d'air chaud et du chauffage de plastification.

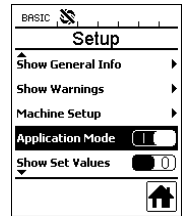

Plast: 80% 222 °C
Heat: 40% 197 °C
Amb.: 25 °C
Mains: 50Hz

Si la fonction «Show Set Values» (Afficher valeurs prédéfinies) est activée, la température réelle (en grand) et la température de consigne (en petit) sont affichées.

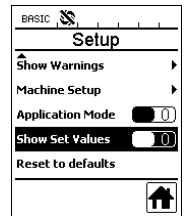

Reset to defaults

Lorsque le menu «Reset to defaults» (Restaurer les paramètres par défaut) est sélectionné et confirmé par la sélection de la fonction , tous les profils spécifiques au client sont effacés. Les réglages ayant été modifiés par le menu Setup sont réinitialisés au réglage d'usine.

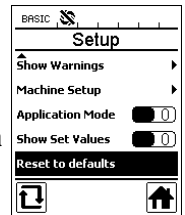

Guidage par menu

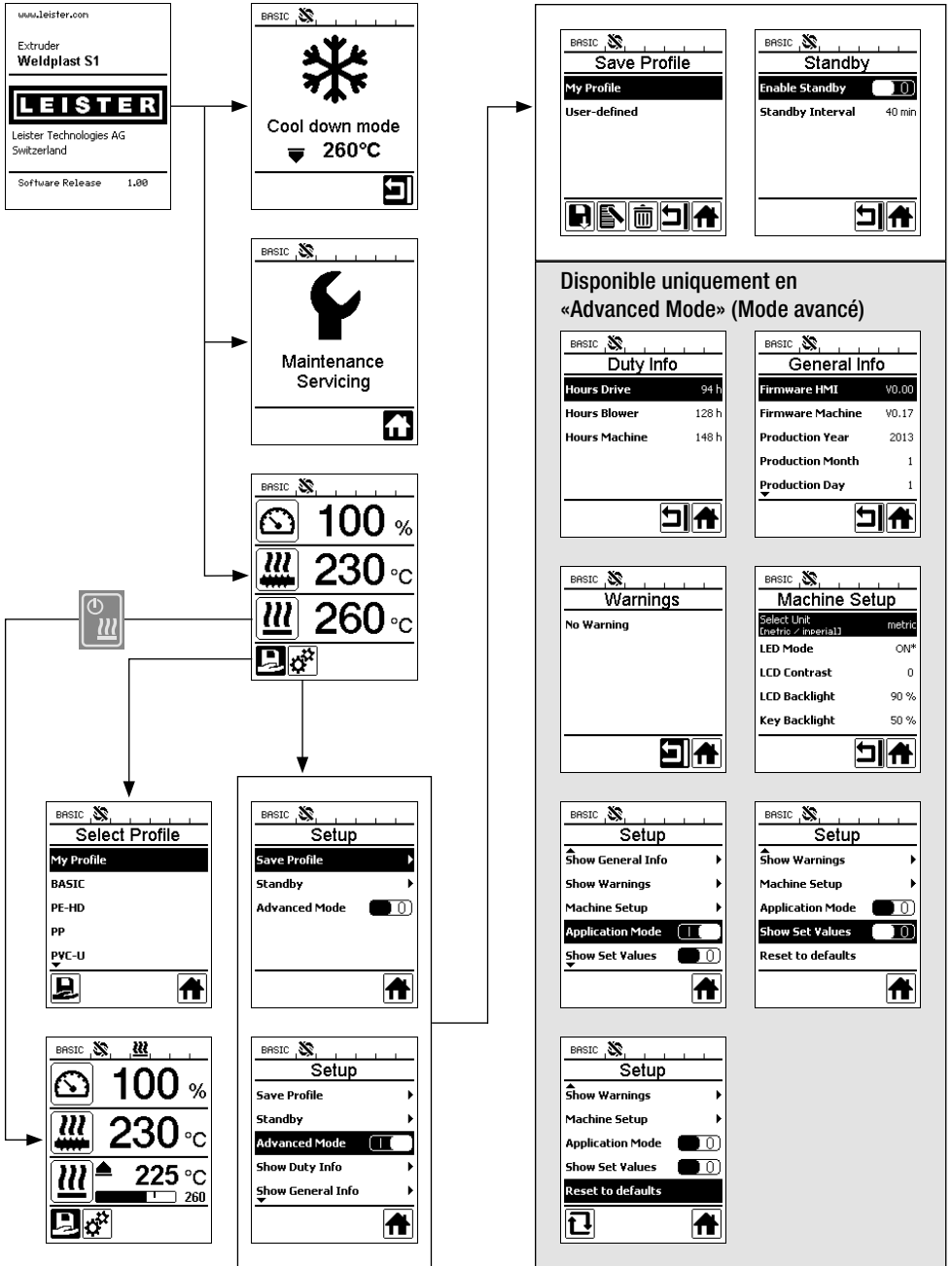

Environnement de travail / Sécurité



Avant la mise en service, contrôlez le câble d'alimentation secteur (13) et la fiche ainsi que le câble de prolongation à la recherche de dommages électriques et mécaniques.

L'extrudeuse manuelle ne doit pas être utilisée dans un milieu où il existe un risque d'explosion ou dans un environnement inflammable. Veillez à garder une position stable pendant les travaux. Le câble d'alimentation secteur et le cordon de soudure doivent toujours être mobiles et ne doivent pas gêner l'utilisateur ou une tierce personne pendant les travaux.

Déposez l'extrudeuse manuelle sur une surface résistante au feu ! Les pièces métalliques chaudes et le jet d'air chaud doivent être suffisamment éloignés de la surface et des murs.

Poste de travail



Pour la mise en service et le rangement de l'extrudeuse manuelle, Leister propose un **reposito** pour outils.

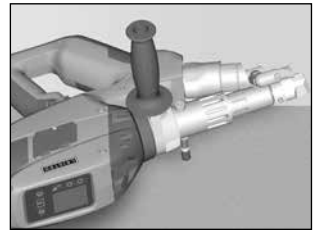
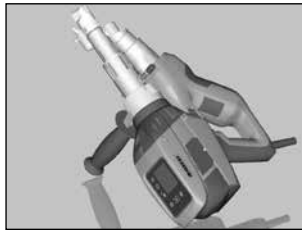

En cas d'interruption des travaux de soudure, l'entraînement doit être coupé à l'aide de l'**interrupteur Marche/Arrêt de l'entraînement (2)**. Poser l'extrudeuse manuelle avec sa **poignée (6)** réglée de manière appropriée et bien serrée (comme sur l'illustration) sur un support stable et résistant au feu ou sur des **goujons de support (32)**.

Poignée

Réglage de la poignée

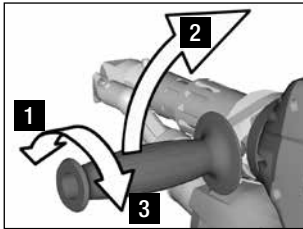

- 1** Desserrer le dispositif de serrage en tournant la **poignée (6)** dans le sens inverse des aiguilles d'une montre.
- 2** Placer la **poignée (6)** dans la position de travail souhaitée.
- 3** Bloquer à nouveau le dispositif de serrage en tournant la **poignée (6)** dans le sens des aiguilles d'une montre.

Démontage / Montage de la poignée

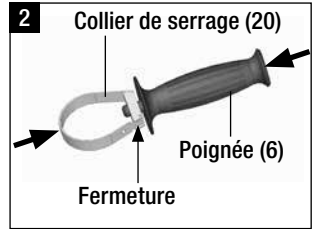
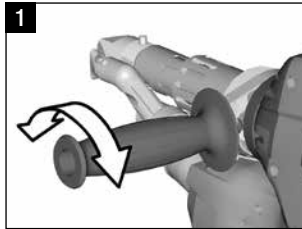

Risque de brûlure ! Laisser refroidir l'appareil

Démontage de la poignée

- 1** Desserrer le dispositif de serrage en tournant la **poignée (6)** dans le sens inverse des aiguilles d'une montre.
- 2** En appuyant sur la **poignée (6)** et sur le **collier de serrage (20)**, la **fermeture s'ouvre (voir les flèches)**. Retirer la **poignée (6)** avec le **collier de serrage (20)**.

La **poignée se monte dans le sens inverse des opérations.**

Câble de prolongation

- En cas d'utilisation de câbles de prolongation, une section minimale doit être respectée :
- Le câble de prolongation doit être homologué pour le lieu d'exploitation (par exemple à l'air libre) et porter les marquages correspondants.
- En cas d'utilisation d'un groupe électrogène pour alimenter l'appareil, la puissance nominale du groupe doit être: 2 x puissance nominale de l'extrudeuse manuelle.

Longueur [m]	Section minimale (à 100 – 230V~) [mm ²]
Jusqu'à 19	2.5
20 – 50	4.0

Démarrage de l'appareil

- Si nécessaire, monter le **patin de soudage (8)** correspondant, la **buse de préchauffage (9)** adéquate ainsi que la **conduite d'air chaud(16)** (voir page 56 pour le changement d'accessoires).



Connecter l'appareil à la tension nominale. La tension nominale indiquée sur l'appareil doit être identique à la tension du secteur.

- Mettre l'extrudeuse en marche à l'aide du **commutateur principal (1)**. Selon la température de l'air de préchauffage, l'affichage de lancement ou la fonction «Cool down mode» (Mode refroidissement) s'affiche sur l'**écran d'affichage (5)**. La phase de montée en température est démarrée en appuyant sur la **touche (23) «Chauffage Marche/Arrêt»**
- Lorsque l'appareil est prêt à l'emploi, l'**éclairage à LED (31)** s'allume automatiquement (réglage d'usine).
- L'entraînement peut être démarré à l'aide de l'**interrupteur Marche/Arrêt de l'entraînement (2)**.

Procédure de soudage

- Introduire le cordon de soudure (ø 3 ou 4 mm) dans l'**orifice d'introduction du cordon de soudure (11)**.
- Le cordon de soudure est automatiquement tiré à l'intérieur par l'**orifice d'introduction du cordon de soudure (11)**. L'introduction du cordon doit s'opérer sans résistance.



ATTENTION !

Toujours utiliser l'appareil muni d'un cordon de soudure, mais ne jamais introduire de cordon de soudure en même temps dans les deux orifices d'introduction de cordon de soudure.

- La vitesse d'introduction du cordon de soudure peut être réglée à l'aide du **potentiomètre (3)**.
- Interrompre la sortie de la matière avec l'**interrupteur Marche/Arrêt de l'entraînement (2)**.
- Diriger la **buse de préchauffage (9)** sur la zone de soudage.
- Préchauffer la zone de soudage en effectuant des mouvements de va-et-vient.
- Placer l'appareil sur la zone de soudage préparée et actionner à nouveau l'**interrupteur Marche/Arrêt de l'entraînement (2)**.
- Procéder à un essai de soudage conformément aux instructions de soudage du fabricant de matériaux et aux normes ou directives nationales. Contrôler l'essai de soudage.
- Si nécessaire, adapter le réglage de la température, le débit et le volume d'air (voir le chapitre «Réglage des paramètres de soudage», page 50).
- Si la procédure de soudage est d'une durée plutôt longue, l'**interrupteur Marche/Arrêt de l'entraînement (2)** peut être maintenu en mode continu à l'aide du **dispositif d'arrêt de l'entraînement (4)**.

ATTENTION !

- Le PVC-U et le PVC-C sont traités dans le menu du PVC-U.
- Pour éviter des dommages dus à la corrosion lors du traitement de PVC-U, PVC-C, ECTFE, PVDF etc., nous recommandons de rincer l'extrudeuse à main avec du HD-PE.





Mise hors tension de l'appareil

- Desserrer le dispositif d'arrêt de l'entraînement (4) et relâcher l'interrupteur Marche/Arrêt de l'entraînement (2).
- Retirer la matière de soudure du **patin de soudage (8)**.
- Le chauffage est arrêté et l'appareil démarre la phase de refroidissement «Cool down mode» en appuyant sur la **touche (23) «Chauffage Marche/Arrêt»**  puis la **touche (25) «Confirmer»**.
- La phase de refroidissement terminée, la soufflerie s'arrête automatiquement et l'affichage de démarrage apparaît sur l'**écran d'affichage (5)**.
- **Désactiver le commutateur principal (1)**.



Débrancher le câble d'alimentation du réseau électrique.

Réglage d'un paramètre

- Si une valeur de consigne doit être modifiée (la température de consigne de la plastification par ex.), la valeur de consigne souhaitée peut être sélectionnée en appuyant sur les **touches 21 / 22 «Haut»**  ou **«Bas»** . Tant que la valeur de consigne est marquée sur l'écran, il est possible de la modifier avec les **touches 24 / 26 «Plus»**  ou **«Minus»** . Quatre valeurs de consigne sont réglables sur la WELDPLAST S1.



Débit (débit max. lorsque le potentiomètre est réglé sur le niveau 5 ou sur 100 %).



température de plastification





Température de l'air

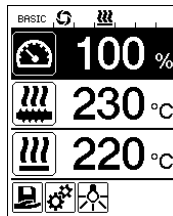

Débit d'air

- L'affichage de travail peut afficher trois éléments au maximum.



- Les autres éléments sont accessibles en appuyant sur les **touches 21 / 22 «Haut»**  ou **«Bas»** .

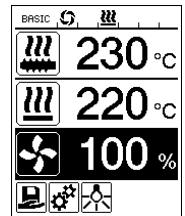



- Le débit peut être réglé directement à l'aide du **potentiomètre (3)** (par pas de 5 %) pendant l'extrusion elle-même. La plage s'étend de 35 % min. au débit max. réglé. La valeur actuellement réglée est toujours visible sur l'affichage de travail. La valeur réglée sur l'affichage de travail est à interpréter comme la valeur maximale. Le **potentiomètre (3)** ne peut être réglé que jusqu'à cette valeur maximale définie. Pour cette raison, elle est généralement réglée sur 100 %.
- Si le débit réglé sur le débit minimum (35 %) est trop important, il faut passer à une section de cordon de soudure de 3 mm.
- Si le débit réglé sur le débit maximum (100 %) est trop faible, il faut passer à une section de cordon de soudure de 4 mm.

Select Profile (sélection de profil)

- Sélection d'un profil prédéfini ou d'un profil libre
- La WELDPLAST S1 possède six profils prédéfinis Leister et jusqu'à dix profils à définir librement.

Profils de soudage		Débit max. [%]	Consigne température plastification [°C / °F]	Consigne température [°C / °F]	Débit d'air [%]
1	BASIC	réglable	réglable	réglable	réglable
2	PE-HD	100	230	260	100
3	PP	100	240	260	100
4	PVC-U	100	200	300	100
5	PVDF	100	250	320	100
6 – 16	profils libres	réglable	réglable	réglable	réglable

- Vous accédez au menu «Select Profile» (Sélectionner un profil) après sélection du symbole  sur l'**affichage des fonctions (27)**. Vous pouvez choisir l'un de ces six profils prédéfinis (1 – 6) ou un profil libre spécifique au client (7 – 16) avec les touches 21/ 22 «Haut»  et «Bas» .
- Si des valeurs de consigne (profils 2 – 16) sont modifiées pendant le fonctionnement, ces valeurs ne seront pas enregistrées dans le profil!
- Si la machine est arrêtée puis remise en marche, sur l'écran apparaissent toujours les valeurs définies dans le profil.
- Vous devez sélectionner le profil BASIC (1) si vous désirez utiliser les valeurs réglées en dernier à la remise en marche de la machine.
- Le profil actuellement sélectionné est visible à gauche dans la «Zone 1» sur l'**affichage d'état (29)**.

PE-HD 

Contrôle des paramètres de soudage

- La température actuelle de plastification et de l'air est contrôlée en permanence. Si une valeur réelle s'écarte de la valeur de consigne correspondante, ceci est indiqué dans l'**affichage de travail (28)** («Show Set Values» (Afficher valeurs prédéfinies) inactif).

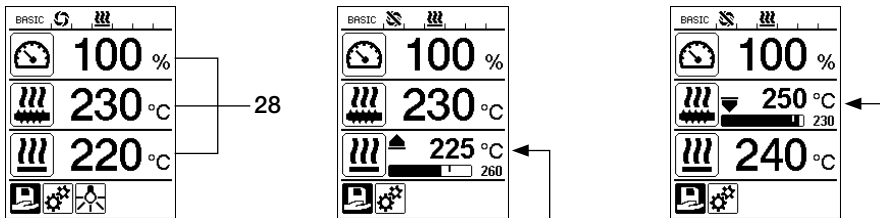

- Valeur réelle correspondant à la valeur de consigne.
- Valeur réelle de la température de l'air trop basse. Phase de montée en température signalée par clignotement (flèche dirigée vers le haut et jauge de progression).
- Valeur réelle de la température de plastification trop élevée. Phase de refroidissement signalée par clignotement (flèche dirigée vers le bas et jauge de progression).

Déverrouillage de l'entraînement

- Quatre durées d'attente possibles existent pour le déverrouillage de l'entraînement (consulter le tableau). Elles dépendent de la température réelle de plastification ainsi que de la température de consigne définie pour la plastification. L'air de préchauffage n'exerce aucune influence sur le déverrouillage de l'entraînement.
- La plage de déverrouillage commence lorsque la température réelle de plastification devient supérieure à la température de consigne – 20K.
- **Symbole correspondant sur l'affichage d'état :**



L'entraînement n'est pas déverrouillé



Entraînement déverrouillé

Température réelle de plastification à la mise en marche du chauffage ou réglage de la température de consigne de plastification	Température de consigne de plastification	Durée de déverrouillage après atteinte de la plage de déverrouillage
Température de consigne de plastification – 5K < température réelle de plastification	—	L'entraînement est déverrouillé directement
Température de consigne de plastification – 20K < température réelle de plastification < température de consigne de plastification – 5K	—	30 s
Température de consigne de plastification – 20K > température réelle de plastification (en dessous de la plage de déverrouillage)	> 190°C	2 min 30 s
Température de consigne de plastification – 20K > température réelle de plastification (en dessous de la plage de déverrouillage)	< 195°C	3 min 30 s

- Si l'entraînement étant déverrouillé, la WELDPLAST S1 ne peut pas maintenir la température réelle de plastification dans la plage de déverrouillage pendant plus de 10 secondes, l'entraînement est de nouveau verrouillé. Dès que l'appareil atteint de nouveau la plage de température de déverrouillage, l'entraînement est déverrouillé selon une durée définie dans le tableau.

Verrouillage des touches





- Le verrouillage des touches est activé ou désactivé en appuyant simultanément au moins pendant 2 secondes sur les **touches 21 / 22 «Haut»**  **et «Bas»** .

Coupeure de secteur





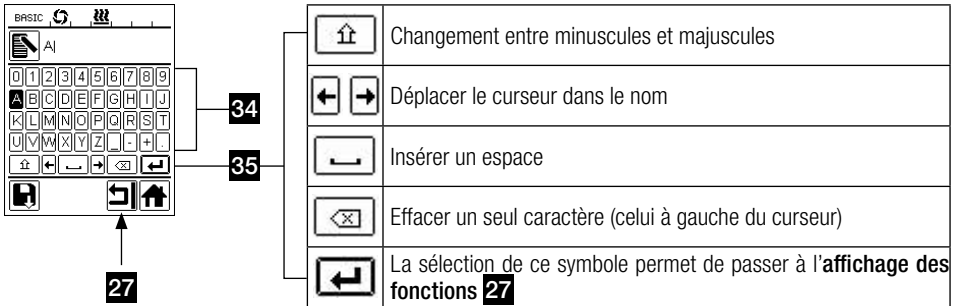

État entraînement avant coupeure	Durée coupeure de secteur	État WELDPLAST S1 après coupeure
Entraînement déverrouillé Fenêtre de travail soudage	≤ 5 s	L'appareil démarre sans protection anti-redémarrage et passe directement à l'état ayant précédé la coupeure de secteur.
Entraînement verrouillé (air de préchauffage > 100 °C)	> 5 s	L'appareil passe directement au «Cool down modus» (Mode refroidissement)
Entraînement verrouillé (air de préchauffage < 100 °C)	> 5 s	L'appareil démarre et l'affichage de démarrage s'affiche à l' écran (5) .

Saisie de noms et de mots de passe













- Le mode clavier permet de définir des noms ou de saisir des mots de passe comportant 12 caractères au maximum.

Mode clavier	Sélection d'un caractère 34	Sélection d'un symbole 35
 	Haut (21) Bas (22)	Sélection verticale d'un caractère
 	Moins (24) Plus (26)	Sélection horizontale d'un caractère
	Confirmer (25)	Confirmer le caractère sélectionné



	Changement entre minuscules et majuscules
 	Déplacer le curseur dans le nom
	Insérer un espace
	Effacer un seul caractère (celui à gauche du curseur)
	La sélection de ce symbole permet de passer à l'affichage des fonctions 27





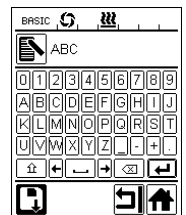
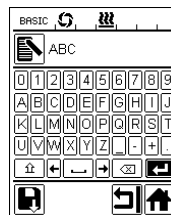
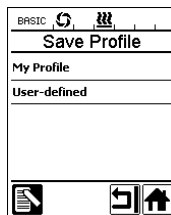
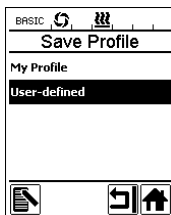
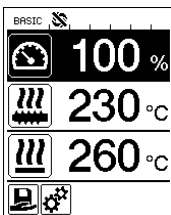







Définition de profils

- Dans le menu «Save Profile» (Enregistrer des profils), les réglages de valeurs de consigne pour le débit max., la température de plastification et de l'air peuvent être enregistrés sous un nom que vous pouvez choisir (voir le chapitre «Saisie de noms et de mots de passe»).
- Création d'un nouveau profil**
 - Sur l'**affichage de travail (28)**, définir les valeurs de consigne souhaitées à l'aide des **touches 24/26 «Plus»**  ou **«Moins»** .
 - Sur l'**affichage des fonctions (27)**, sélectionner le menu Réglages  avec la **touche 26 «Plus»** .
 - Dans le menu «Setup» (Réglages), sélectionner «Save Profile» (enregistrer le profil) avec la **touche 26 «Plus»** .
 - Sélectionner le profil «User-defined» (défini par l'utilisateur) et confirmer avec la **touche (25)** .
 - Sur l'**affichage des fonctions (27)**, sélectionner le symbole  «Éditer la position sélectionnée» et confirmer avec la **touche (25)** .
 - Saisir le nom du profil (voir le chapitre Saisie de noms et de mots de passe), puis sélectionner avec la **touche 26 «Plus»**  le symbole  et confirmer avec la **touche (25)** .
 - Sur l'**affichage des fonctions (27)**, confirmer le symbole sélectionné «Enregistrer»  avec la **touche (25)** . Le profil est enregistré et sélectionné.



Définition de profils

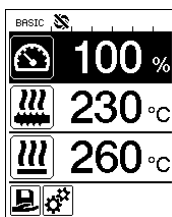

• Éditer un profil existant (excepté les profils Leister) :

- Sur l'**affichage de travail (28)**, définir les valeurs de consigne souhaitées à l'aide des **touches 24/26 «Plus»**  ou **«Moins»**  .
- Sur l'**affichage des fonctions (27)**, sélectionner le menu Réglages  avec la **touche 26 «Plus»**  .
- Dans le menu «Setup» (Réglages), sélectionner «Save Profile» (enregistrer le profil) avec la **touche 26 «Plus»**  .
- Sélectionner le profil à éditer et confirmer avec la **touche (25)**  .
- Sur l'**affichage des fonctions (27)**, sélectionner le symbole  «Éditer la position sélectionnée» et confirmer avec la **touche (25)**  .
- Saisir le nom du profil (voir le chapitre Saisie de noms et de mots de passe), puis sélectionner avec la **touche 26 «Plus»**  le symbole  et confirmer avec la **touche (25)**  .
- Sur l'**affichage des fonctions (27)**, confirmer le symbole sélectionné «Enregistrer»  avec la **touche (25)**  . Le profil est enregistré et sélectionné.



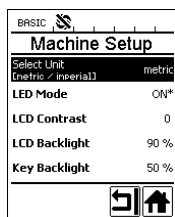



Réglages de la machine



Menu	Fonction
Select Unit	Réglage de l'unité utilisée : – système métrique / impérial
LED Mode	<p>Mode LED :</p> <ul style="list-style-type: none"> – ON* : l'éclairage à LED ne peut être allumée que si l'entraînement est déverrouillé. Dès que l'entraînement est déverrouillé, le symbole LED  apparaît sur l'affichage des fonctions (27). Ce symbole permet d'allumer ou d'éteindre l'éclairage à LED. Le mode LED reste inchangé. – ON : l'éclairage à LED est toujours allumé. Sur l'affichage des fonctions (27), le symbole LED  apparaît. Ce symbole permet d'allumer ou d'éteindre l'éclairage à LED. Le mode LED reste inchangé. – OFF : l'éclairage à LED est toujours éteint.
LCD Contrast	Réglage du contraste de l'écran LCD
LCD Backlight	Réglage du rétro-éclairage de l'écran
Key Backlight	Réglage du rétro-éclairage du clavier

Avertissements et messages d'erreur

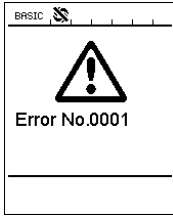
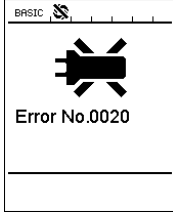
- Lorsqu'un avertissement est généré, l'utilisateur peut poursuivre son travail sans restriction. Il peut consulter des informations plus précises concernant l'avertissement sur l'**affichage des fonctions (27)** sous «Show Warnings» (afficher avertissements) dans le menu Réglages .
- Si une erreur se produit, l'appareil coupe tous les chauffages et l'entraînement se verrouille.

Type de message	Affichage	Code d'erreur	Description de l'erreur
Avertissement		—	Symbole d'avertissement  sur l' affichage d'état (30) . Les charbons de l'entraînement doivent être remplacés. L'entraînement peut encore fonctionner pendant 5 heures après la première apparition du symbole d'avertissement. Ensuite, le message d'erreur « Error No.0400 » apparaît et l'entraînement est verrouillé.
Erreur		0001	Température excessive de l'appareil. Laisser refroidir l'appareil.
		0020	Résistance chauffage de l'air défectueuse.
Erreur ! Contacter le centre S.A.V. de Leister.		0004	Erreur matérielle.
		0008	Thermocouple chauffage de l'air défectueux.
		0010	Thermocouple pour plastification défectueux.
		0040	Résistance pour plastification défectueuse.
		0100	Soufflerie défectueuse.
		0200	Erreur de communication.
0400	Charbons de l'entraînement ou température excessive de l'entraînement.		

Changement d'accessoires



Risque de brûlure !



Travaillez uniquement avec des gants résistants aux températures élevées.

Changement du patin de soudage

• Démontage

- Arrêter l'appareil chaud et le débrancher du réseau électrique.
- Retirer le **patin de soudage (8)** en desserrant les **vis de blocage (18)** de la **buse d'extrusion (17)**.
- Nettoyer la **buse d'extrusion (17)** à chaque changement de patin de soudage pour enlever les résidus de soudure et vérifier qu'elle est bien vissée.

• Montage

- Insérer un **patin de soudage (8)** adapté au cordon de soudure sur la **buse d'extrusion (17)** et le fixer en serrant les **vis de blocage (18)**.

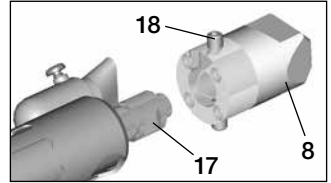

Remplacement de la conduite d'air chaud

• Démontage

- Desserrer la **vis de blocage (33)**. La **conduite d'air chaud (16)** peut être sortie ou tournée dans le sens de soudage souhaité.
- Monter une **conduite d'air chaud (16)** adéquate (voir le chapitre Sens de soudage).
- Serrer la **vis de blocage (33)**.

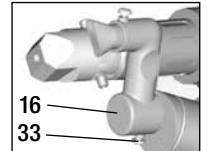

Remplacement de la buse de préchauffage

• Démontage

- Desserrer la **vis de blocage (19)** sur la **buse de préchauffage (9)** et sortir la **buse de préchauffage (9)** de la **conduite d'air chaud (16)**.

• Montage

- Insérer la **buse de préchauffage (9)** sur la **conduite d'air chaud (16)**. Veiller à une orientation parallèle par rapport au **patin de soudage (8)**.
- Serrer la **vis de blocage (19)**.

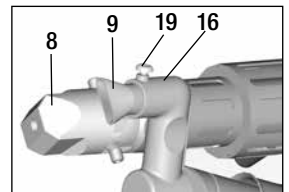

Sens de soudage

- La conduite d'air chaud appropriée au sens de soudage.

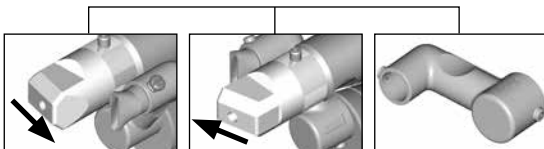

Sens de soudage

Conduite d'air chaud



Sens de soudage

Conduite d'air chaud

Accessoires

- Utiliser uniquement des accessoires Leister pour des raisons techniques et de sécurité.
- Accessoires sur le site www.leister.com

Assortiment de patins de soudage

- Leister Technologies AG propose des patins de soudage adaptés à toutes les formes courantes de cordon de soudure, en différentes dimensions :

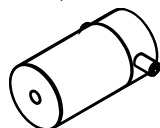

pièce brute

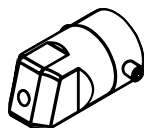

soudure d'angle

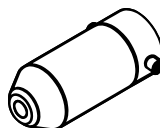

Soudure en angle

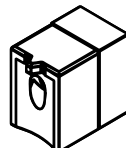







cordon en V

Conduite d'air chaud



Buse de préchauffage

- Leister Technologies AG propose diverses buses de préchauffage afin d'obtenir un préchauffage optimal, vu la variété offerte en patins de soudage.

bec à souder	Largeur du cordon de soudure mm	Buses de préchauffage			
		 Largeur 21 mm Longueur 26 mm	 Largeur 21 mm Longueur 42 mm	 ∅ 14 mm Longueur 58 mm coudée	 ∅ 14 mm Longueur 46 mm
soudure d'angle 	5 / 6			• (b)	•
	8 / 10			• (b)	•
	12			• (b)	•
Soudure en angle 				• (b)	•
cordon en V 	3 / 4	•	• (a)		
	5 / 6	•	• (a)		
	8 / 10	•	• (a)		

a) Patins de soudage conformes à DVS analogues à WELDPLAST S2-PVC.

b) Buse de préchauffage coudée pour un préchauffage parfait dans le cas de soudage de tubes radiaux.

Entretien

- Contrôlez le câble d'**alimentation secteur (13)** et la fiche à la recherche de dommages électriques et mécaniques
- Éliminez les résidus de matière de soudure au niveau de la **buse d'extrusion 17)** à chaque remplacement du patin de soudage

Service und Reparatur

- Les réparations doivent être réalisées exclusivement par les **SAV Leister** compétents. Ils garantissent un **service de réparation** approprié et fiable **sous 24 heures** avec des pièces détachées d'origine, conformément aux schémas de câblage et aux listes des pièces de rechange.
- Si après la mise en marche de WELDPLAST S1, le message «Maintenance servicing» (maintenance) s'affiche, il convient de faire contrôler le moteur de l'entraînement (collecteur et balais) par un centre de service Leister autorisé et de le remplacer, si besoin est. Ce message disparaît automatiquement après 10 secondes. Il est aussi possible de le sauter directement en **appuyant sur la touche (25)**  «Confirmer».

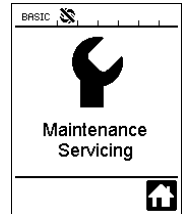

Garantie légale

- Les droits de garantie fabricant et de garantie légale accordés par le partenaire commercial ou vendeur direct s'appliquent à cet appareil à compter de la date d'achat. En cas de recours à la garantie (justificatif par la facture ou le bordereau de livraison), les défauts de fabrication ou d'usure seront supprimés par le partenaire commercial qui procédera à une fourniture en remplacement ou à une réparation. Les éléments chauffants sont exclus de la garantie.
- Toute autre prétention à la garantie fabricant ou à la garantie légale dans le cadre du droit en vigueur est exclue.
- Les dommages résultant d'une usure naturelle, d'une surcharge ou d'un traitement non conforme sont exclus de la garantie.
- Aucun droit à revendication n'est accordé pour les appareils qui auront été transformés ou modifiés par l'acheteur.



Prima dell'attivazione leggere con attenzione le istruzioni per l'uso e conservarle per ulteriori consultazioni.

Leister WELDPLAST S1 Estrusore per saldatura manuale

Applicazione

- Saldatura ad estrusione dei materiali riportati di seguito:
PP / PE-HD / PVC-U / PVC-C / PVDF
- Altri materiali su richiesta



Avvertenza



Aperto l'apparecchio è presente il **pericolo di morte** perché vengono esposti componenti e collegamenti sotto tensione. Estrarre la spina elettrica prima di procedere all'apertura dell'apparecchio.



È presente il **pericolo di incendio e di esplosione** in caso di utilizzo non conforme dell'estrusore per saldatura manuale (ad esempio, surriscaldamento del materiale), in particolare nelle vicinanze di materiali infiammabili e gas esplosivi.



Pericolo di ustione: non toccare i componenti metallici scoperti e il materiali fuoriusciti ad alte temperature. Lasciar raffreddare l'apparecchio. Non orientare il getto di aria calda e il materiale in uscita verso persone o animali.



Collegare l'apparecchio ad una **presa di corrente dotata di conduttore di terra**. Tutte le interruzioni del conduttore di terra all'interno o all'esterno dell'apparecchio sono pericolose.

Utilizzare esclusivamente cavi di prolunga dotati di conduttore di terra!



Attenzione



La **tensione nominale** specificata sull'apparecchio deve coincidere con la tensione di rete. In caso di black-out è necessario disattivare l'interruttore principale e il motore (rimuovere l'arresto).



Se si utilizza l'apparecchio in cantiere, sono **tassativamente necessari** gli **interruttori per correnti di guasto** per garantire la tutela del personale.



Pericolo di abbagliamento! Evitare il contatto visivo diretto con il raggio di luce LED. È necessario mantenere l'apparecchio sotto **controllo** durante il funzionamento. Il calore può raggiungere materiali infiammabili che si trovano fuori dal campo visivo. L'impiego dell'apparecchio è consentito esclusivamente a **personale specializzato** o sotto il monitoraggio di quest'ultimo. È tassativamente vietato l'impiego da parte dei bambini.



Proteggere l'apparecchio da umidità e da ambienti bagnati.

Conformità

Leister Technologies AG, Galileo-Strasse 10, CH-6056 Kaegiswil/Svizzera dichiara che il presente prodotto, nella versione introdotta sul mercato, soddisfa i requisiti delle direttive CE riportate di seguito.

Direttive:	2006/42, 2004/108 (fino al 19.04.2016), 2014/30 (dal 20.04.2016), 2006/95 (fino al 19.04.2016), 2014/35 (dal 20.04.2016), 2011/65
Norme armonizzate:	EN 12100, EN 55014-1, EN 55014-2, EN 61000-6-2, EN 61000-3-2, EN 61000-3-3, EN 62233, EN 60335-1, EN 60335-2-45, EN 50581

Kaegiswil, 04.02.2016

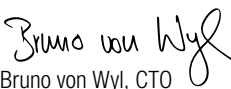
Bruno von Wyl, CTO

Andreas Kathriner, GM

Smaltimento



Gli apparecchi elettrici, gli accessori e gli imballaggi devono essere riciclati nel rispetto dell'ambiente. **Solo per i Paesi UE:** Non smaltire gli apparecchi elettrici insieme ai rifiuti domestici!

Specifiche tecniche

Tensione	V~	100	120	230
Potenza	W	1500	1800	1600
Frequenza	Hz	50/60	50/60	50/60
Temperatura dell'aria max.	°C	max. 360		
Temperatura di plastificazione max.	°C	max. 260		
Espulsione (Ø 3 mm)	kg/h	HD-PE 0.2–0.5; PP 0.2–0.5		
Espulsione (Ø 4 mm)	kg/h	HD-PE 0.3–0.8; PP 0.3–0.75		
Filo per saldatura	mm	Ø 3 / Ø 4		
Livello delle emissioni acustiche	L _{pA} (dB)	76 (K = 3 dB)		
Dimensioni L × l × a	mm	435 × 264 × 91 (senza pattino di saldatura)		
Peso	kg	4.7 (senza linea di allacciamento alla rete)		
Marchio di conformità		CE	CE	CE
Marchi sicurezza				Ⓢ
Classe di protezione I		Ⓛ	Ⓛ	Ⓛ

Con riserva di modifiche tecniche

Descrizione dell'apparecchio

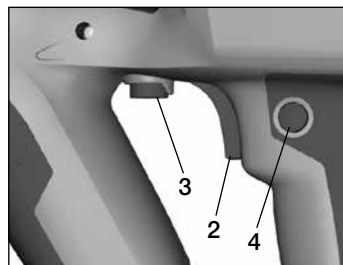
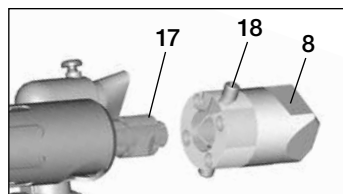
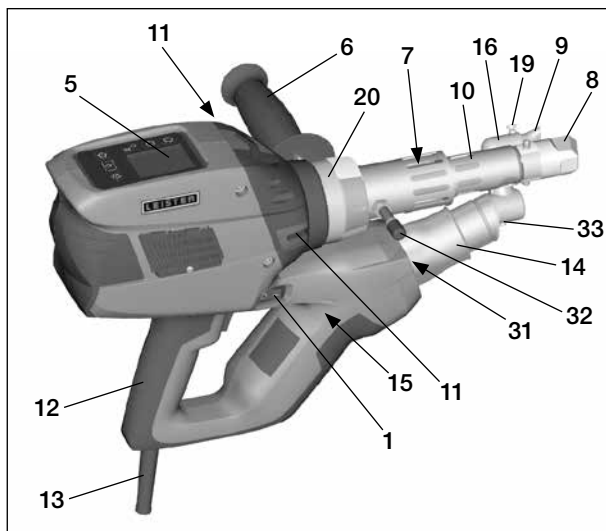

- | | |
|----------------------------------------|-------------------------------------------------|
| 1 Interruttore principale | 13 Cavo di collegamento alla rete |
| 2 Interruttore di avvio/arresto motore | 14 Elemento riscaldante - Tubo di protezione |
| 3 Potenziometro | 15 Soffiante (senza carboncini) |
| 4 Bloccaggio azionamento | 16 Condotta aria calda |
| 5 Display | 17 Ugello estrusore |
| 6 Impugnatura | 18 Pattino di saldatura con vite di fermo |
| 7 Riscaldamento rivestimento | 19 Ugello di preriscaldamento con vite di fermo |
| 8 Pattino di saldatura | 20 Fascia di bloccaggio |
| 9 Ugello di preriscaldamento | 31 Luce LED |
| 10 Tubo di protezione | 32 Bullone di supporto |
| 11 Inserimento per filo di saldatura | 33 Condotta aria calda con vite di fermo |
| 12 Maniglia dell'apparecchio | |

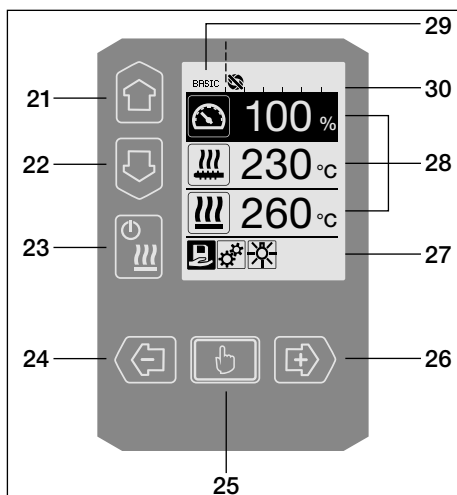









Unità di controllo

- 21 Pulsante "Su"
- 22 Pulsante "Giù"
- 23 Pulsante riscaldamento "Acc. / Spento"
- 24 Pulsante "Meno"
- 25 Pulsante "Conferma"
- 26 Pulsante "Più"

Display

- 27 Schermata funzioni
- 28 Schermata del processo
- 29 Schermata di stato "Campo 1"
- 30 Schermata di stato "Campo 2"

Descrizione dell'unità di controllo





Funzione tastiera	Selezione corrente nella schermata del processo	Selezione corrente nella schermata funzioni
  Su (21) Giù (22)	Cambio di posizione nella schermata del processo	Cambio da schermata funzioni a schermata del processo
 Riscaldamento Accesso / Spento (23)	Nessuna funzione	Cambio da modalità saldatura a processo di raffreddamento Cambio da processo di raffreddamento a modalità saldatura Cambio indicazione da inizio a modalità saldatura
  Meno (24) Più (26) (premere brevemente)	Impostazione dei valori nominali con incrementi di 5 °C o 5%.	Cambio di posizione nella schermata funzioni
  Meno (24) Più (26) (tenere premuto)	Impostazione dei valori nominali con incrementi di 10 °C o 10%.	Cambio di posizione nella schermata funzioni
 Conferma (25)	Il valore impostato viene applicato direttamente e la selezione riporta direttamente alla schermata funzioni	Viene eseguita la funzione selezionata

Descrizione dei simboli sul display

Schermata di stato "Campo 1" (29)

PE-HD	Profilo attualmente scelto. Nel caso di nomi di profilo composti da più di 6 caratteri, verranno mostrati inizialmente i primi 6 caratteri, quindi i restanti.
1m16s	Ritardo restante prima dello sblocco del motore (1 min. / 16 sec.)

Schermata di stato "Campo 2" (30)

 Motore sbloccato	
 Motore bloccato	
 Avvertenza (Spazzole di carbone / Motore)	
 Blocco pulsanti (in caso di blocco pulsanti attivo)	
 Il riscaldatore dell'aria e il plastificatore a caldo sono accesi	

Schermata funzioni e schermata del processo

- Nella schermata funzioni e nella schermata del processo, il campo o l'icona contrassegnati rappresentano sempre la selezione corrente.
- Nella schermata del processo viene mostrato sempre il valore reale. Nel caso in cui si scelga una posizione, viene mostrato il valore nominale.
- Attivando la funzione "Show Set Values" [Mostra valori impostati] compaiono il valore nominale e quello reale (in piccolo).

Schermata funzioni (27)	
	Selezione di profili predefiniti e personalizzati
	Impostazioni
	Tornare alla schermata del processo (uscita diretta da uno dei menu)
	Accensione / spegnimento LED. Questa funzione è presente solo se il LED è stato attivato.
	Indietro di un livello
	Resetare le impostazioni o il contaore
	Menu assistenza (disponibile solo con immissione password)
	Salvataggio
	Eliminare la posizione selezionata
	Modificare la posizione selezionata
	Avviare il processo di raffreddamento

Schermata del processo (28)	
	Valore nominale: Capacità di produzione [%]
	Valore nominale: Temperatura di plastificazione [°C / °F]
	Valore nominale: Temperatura dell'aria [°C / °F]
	Valore nominale: Quantità d'aria [%]
	Finestra informativa
	La freccia verso l'alto e la barra di progressione indicano che il valore nominale (segno presente sulla barra di progressione) non è ancora stato raggiunto (troppo freddo). Il valore lampeggiante è il valore reale. Il valore che si trova accanto alla barra di progressione è il valore nominale impostato.
	La freccia verso il basso e la barra di progressione indicano che il valore nominale (segno presente sulla barra di progressione) non è ancora stato raggiunto (troppo caldo). Il valore lampeggiante è il valore reale. Il valore che si trova accanto alla barra di progressione è il valore nominale impostato.
	Attivando la funzione "Show Set Values" [Mostra valori impostati] vengono visualizzate la temperatura reale (in grande) e quella nominale (in piccolo).
	Processo di raffreddamento
	Apparecchio in modalità standby. Al termine del conteggio da parte del contatore, l'apparecchio avvia la modalità "Cool down modus" [Modalità raffreddamento]
	Errore dell'apparecchio. È presente, inoltre, un codice di errore (al momento, l'apparecchio non è più utilizzabile). Contattare il punto assistenza autorizzato
	Guasto aria elemento riscaldante
	Temperatura dell'apparecchio troppo elevata. Fare raffreddare l'apparecchio.

Schermata di avvio



Schermata che compare all'avvio. Presenta la versione del software dell'unità di potenza.



Modalità cool down (raffreddamento)

In questa modalità, i riscaldatori sono spenti e l'apparecchio è in modalità di raffreddamento.

Se, in fase di spegnimento dell'apparecchio, la temperatura di preriscaldamento dell'aria è maggiore di 100 °C, l'apparecchio passa automaticamente alla modalità "Cool down" [Modalità raffreddamento]. Il processo viene interrotto se la temperatura di preriscaldamento dell'aria resta al di sotto dei 100 °C per 2 min.

Se è necessario accendere nuovamente i riscaldatori, premere il **pulsante (23)**  o il **pulsante (25)**  "Conferma"

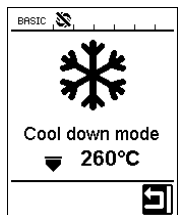

Maintenance servicing (Tagliando di controllo)

In caso di superamento del lasso di tempo tra un controllo e il successivo, dopo la schermata di avvio, apparirà la dicitura "Maintenance Servicing" [Tagliando di controllo].

Premendo il **pulsante (25)**  "Conferma" è possibile proseguire con il lavoro. L'apparecchio deve essere portato al rispettivo punto assistenza.



Schermata di inizio

La schermata di inizio presenta tutti i valori nominali. Il riscaldatore non è ancora acceso; tuttavia, è già possibile impostare tutti i valori nominali.

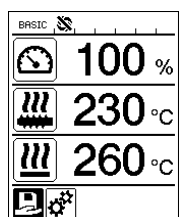

Schermata di avvio Saldatura

Schermata durante il riscaldamento

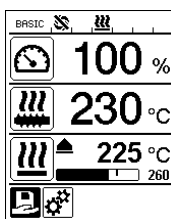

Select Profile [Seleziona profilo]

Selezionare un profilo personalizzato o predefinito da Leister.

Per una descrizione dettagliata relativa alla selezione del profilo, consultare il capitolo "Select Profile" [Seleziona profilo], pagina 70.

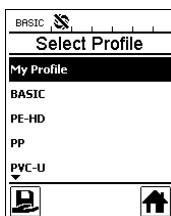

Setup (Impostazione)

È possibile raggiungere l'impostazione base dal menu "Setup" [Configurazione] nel profilo memorizzato e nella funzione Standby. Selezionando "Advanced Mode" [Modalità avanzata] è possibile accedere a molte altre opzioni di configurazione.

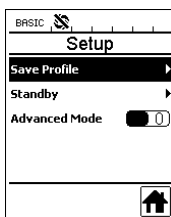

Save profile [Salva profilo] (Definire un profilo personalizzato)

Per una descrizione dettagliata relativa alla memorizzazione di profili, consultare il capitolo "Definizione profili", pagine 72 / 73.



Panoramica delle schermate del processo

Standby (Attesa)

Se la modalità di attesa è stata attivata e, durante il lasso di tempo definito in **“Standby Interval”** [Intervallo di attesa], non viene attivato alcun pulsante sull'unità di controllo o l'**interruttore di avvio/arresto motore (2)**, l'apparecchio passa automaticamente alla schermata Standby. Se entro i 180 sec. successivi, non viene premuto il **pulsante (25)**  **“Conferma”**, la modalità di raffreddamento automatica si avvia automaticamente.

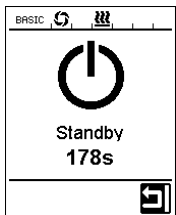
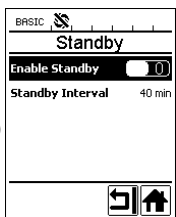

Duty Info [Info servizio]

Hours Drive

[Durata di esercizio]: durata di esercizio effettiva del motore (azzerabile).

Hours Blower

[Durata esercizio soffiante]: durata di esercizio effettiva del soffiante.

Hours Machine

[Durata esecuzione macchina]: durata di esecuzione effettiva della macchina.



General Info

Firmware HMI [Firmware HMI]: Versione del software dell'interfaccia (modulo di comunicazione).

Firmware Machine [Firmware macchina]: Revisione del software dell'unità di potenza.

Production Info

[Info produzione]: Informazioni al momento della produzione.

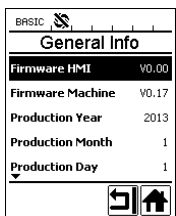

Warnings [Avvertenze]

Le avvertenze vengono segnalate con un simbolo nella schermata di stato . Nel menu “Warnings” [Avvertenze] Si trovano maggiori informazioni relative alle avvertenze segnalate.



Machine Setup

[Configurazione macchina]

Per una descrizione dettagliata delle impostazioni della macchina, consultare il capitolo “Impostazioni della macchina”.

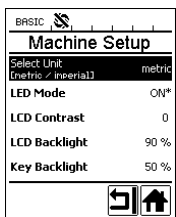

Application Mode

[Modalità applicazione]

Se “Application Mode” [Modalità applicazione] è attivo, nella schermata processo sono disponibili informazioni dettagliate relative alla temperatura reale di plastificazione e al carico massimo del soffiante ad aria calda e del plastificatore a caldo.



Plast [Plast]: 80% 222 °C
Heat [Calore]: 40% 197 °C
Amb. [Amb.]: 25 °C
Mains [Alim.]: 50 Hz

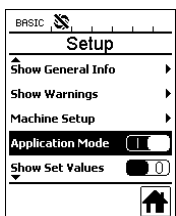

Attivando la funzione “Show Set Values” [Mostra valori impostati] vengono visualizzate la temperatura reale (in grande) e quella nominale (in piccolo).

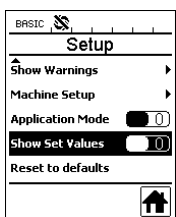

Reset to defaults [Reimposta predefiniti]

Se il menu “Reset to defaults” [Reimposta predefiniti] viene selezionato e confermato mediante la funzione , tutti i profili personalizzati vengono cancellati. Tutte le impostazioni modificate tramite il menu di Setup, vengono riconfigurate ai valori predefiniti.

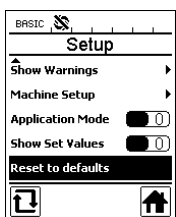

www.leister.com

Extruder
Weldplast S1



Leister Technologies AG
Switzerland

Software Release 1.00

BASIC 

Cool down mode

260 °C



BASIC 

Maintenance Servicing





BASIC 

100 %

 230 °C

 260 °C



BASIC 

Select Profile

My Profile

BASIC

PE-HD

PP

PVC-U



BASIC 

Setup

Save Profile

Standby

Advanced Mode



BASIC 

100 %

 230 °C

 225 °C

260



BASIC 

Setup

Save Profile

Standby

Advanced Mode

Show Duty Info

Show General Info









BASIC 

Save Profile

My Profile

User-defined









BASIC 

Standby

Enable Standby 0

Standby Interval 40 min

Disponibile solo in "modalità avanzata"



BASIC 

Duty Info

Hours Drive 94 h

Hours Blower 128 h

Hours Machine 148 h

BASIC 

General Info



Firmware HMI V0.00

Firmware Machine V0.17

Production Year 2013

Production Month 1



Production Day 1





BASIC 

Warnings

No Warning

BASIC 

Machine Setup



Select Unit (Metric / Imperial) metric

LED Mode ON*

LCD Contrast 0

LCD Backlight 90 %

Key Backlight 50 %

BASIC 

Setup

Show General Info

Show Warnings

Machine Setup

Application Mode

Show Set Values



BASIC 

Setup

Show Warnings

Machine Setup

Application Mode

Show Set Values

Reset to defaults



BASIC 

Setup



Show Warnings

Machine Setup

Application Mode

Show Set Values

Reset to defaults



Prima della messa in funzione controllare il linea di allacciamento alla rete (13), la spina e la prolunga, per accertarne l'integrità elettrica e meccanica.

Non è consentito utilizzare l'estrusore per saldatura manuale in ambienti a rischio d'esplosione o infiammabili. Prestare attenzione alla stabilità durante le operazioni. La linea di allacciamento alla rete e il filo per saldatura devono potersi muovere senza problemi senza ostacolare l'utente e o terze persone durante le operazioni.

Disporre l'estrusore per saldatura manuale su una base ignifuga. Le parti in metallo e il getto di aria calda devono presentare una distanza adeguata dal supporto e dalle pareti.

Postazione di lavoro/platz

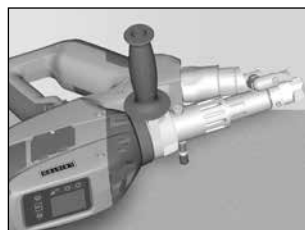

Per la messa in servizio e l'appoggio dell'estrusore per saldatura manuale Leister offre un **supporto per apparecchiature**.

Qualora si interrompano le operazioni di saldatura, il motore deve essere arrestato mediante l'apposito **interruttore di avvio/arresto motore (2)**. Collocare l'estrusore per saldatura manuale con l'**impugnatura (6)** debitamente regolata e ben serrata su una base stabile e refrattaria oppure sul **bullone di supporto (32)** secondo l'esempio indicato in figura.

Impugnatura

Regolazione dell'impugnatura

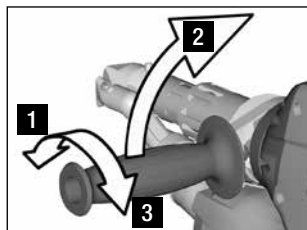

- 1** Rilasciare il blocco ruotando l'**impugnatura (6)** in senso antiorario.
- 2** Regolare l'**impugnatura (6)** nella posizione desiderata.
- 3** Fissare il blocco ruotando l'**impugnatura (6)** in senso orario.

Smontaggio / montaggio dell'impugnatura

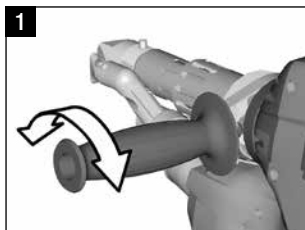

Pericolo di scottature! Fare raffreddare l'apparecchio

Smontaggio dell'impugnatura

- 1** Rilasciare il blocco ruotando l'**impugnatura (6)** in senso antiorario.
- 2** Premendo l'**impugnatura (6)** e la **fascia di bloccaggio (20)** la **chiusura (vedere freccia)** si apre. Rimuovere l'**impugnatura (6)** e la **fascia di bloccaggio (20)**.

Il montaggio della maniglia viene eseguito seguendo l'ordine inverso.

Cavo di prolunga

- Prestare attenzione alla sezione minima quando si utilizzano i cavi di prolunga:
- Il cavo di prolunga deve essere omologato per il luogo d'impiego (ad es. per esterni) e dotato delle marcature adeguate.
- Quando si utilizza un gruppo di alimentazione elettrica, la sua potenza nominale deve essere pari al doppio della potenza nominale dell'estrusore per saldatura manuale.

Lunghezza [m]	Sezione minima trasversale (a 100 – 230V~) [mm ²]
Fino a 19	2.5
20 – 50	4.0

Avvio dell'apparecchio

- Montare in base alla necessità il **pattino di saldatura (8)**, l'**ugello di preriscaldamento (9)** e la **condotta dell'aria calda (16)** corrispondenti (cambio degli accessori, pagine 75).



Collegare l'apparecchio al valore di tensione nominale. Tensione nominale: quella indicata sull'apparecchio deve corrispondere alla tensione di rete.

- Attivare l'estrusore mediante l'**interruttore principale (1)**.
A seconda della temperatura di preriscaldamento dell'aria, sul **display (5)** apparirà la schermata di avvio o la modalità "Cool down mode" [Modalità raffreddamento]. Premendo il **pulsante (23) "Riscaldamento Acc. / Spento"**  si attiva il processo di riscaldamento.
- Quando l'apparecchio è pronto per l'uso, la **luce LED (31)** si accende automaticamente (impostazione predefinita).
- Il motore si attiva mediante l'**interruttore di avvio/arresto motore (2)**.

Processo di saldatura

- Introdurre il filo per saldatura (\varnothing 3 o 4 mm) nell'apposito foro di **inserimento per filo di saldatura (11)**.
- Il filo per saldatura verrà caricato automaticamente attraverso l'apposito foro di **inserimento per filo di saldatura (11)**. L'avanzamento del filo deve avvenire senza alcuna resistenza.



ATTENZIONE!

Azionare l'apparecchio sempre in presenza del filo per saldatura, ma non introdurre in nessun caso il filo per saldatura in entrambi i fori.

- La velocità di alimentazione del filo per saldatura è regolata mediante il **potenziometro (3)**.
- Interrompere l'uscita del materiale mediante l'**interruttore di avvio/arresto motore (2)**.
- Orientare l'**ugello di preriscaldamento (9)** verso il settore da saldare.
- Preriscaldare il settore con movimenti oscillatori.
- Collocare l'apparecchio sul settore da saldare preriscaldato e agire sull'**interruttore di avvio/arresto motore (2)**.
- Eseguire un test di saldatura secondo le istruzioni di saldatura del produttore del materiale e in conformità con gli standard o le direttive nazionali. Valutare il test di saldatura.
- Adattare secondo necessità la regolazione della temperatura, la capacità di produzione e la quantità d'aria (consultare il capitolo configurazione dei parametri di saldatura, pagina 69).
- In caso di processi di saldatura di maggiore durata, è possibile bloccare in posizione l'**interruttore di avvio/arresto motore (2)** mediante il dispositivo di **bloccaggio azionamento (4)**.

ATTENZIONE!

- Lavorare i materiali in PVC-U e PVC-C nell'ambito del menu relativo al PVC-U.
- Per evitare i danni dovuti alla corrosione durante la lavorazione di materiali in PVC-U, PVC-C, ECTFE, PVDF, ecc., si raccomanda di pulire l'estrusore per saldatura manuale con HD-PE al termine dell'operazione di saldatura.





Spegnimento dell'apparecchio

- **Disinserire il bloccaggio azionamento (4)** e sbloccare l'**interruttore di avvio/arresto motore (2)**.
- **Rimuovere il materiale** di saldatura presente nel **pattino (8)**.
- Premendo il **pulsante (23) "Riscaldamento Acc. / Spento"**  e mediante il **pulsante (25) "Conferma"** il riscaldatore si spegne e l'apparecchio avvia il processo di raffreddamento "Cool down mode" [Modalità raffreddamento].
- Al termine del processo di raffreddamento, sul **Display (5)** appare la schermata di avvio.
- Spegnerne l'**interruttore principale (1)**.



Scollegare il cavo di collegamento dalla rete.

Regolazione di un parametro

- Se è necessario modificare un valore nominale (ad es. la temperatura nominale di plastificazione), premere i **pulsanti 21/22 "Su"**  o **"Giù"**  per selezionare il valore nominale corrispondente. Finché il valore nominale è evidenziato, può essere modificato mediante i **pulsanti 24 / 26 "Più"**  o **"Meno"** . Nella WELDPLAST S1 è possibile regolare quattro valori nominali:



Capacità di produzione (produzione max. con il potenziometro impostato sul livello 5, cioè al 100%).



Temperatura di plastificazione



Temperatura dell'aria



Quantità d'aria

- Nella schermata del processo è possibile visualizzare un massimo di tre elementi contemporaneamente.

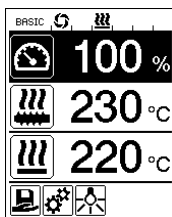

- Premendo i **pulsanti 21/22 "Su"**  o **"Giù"**  è possibile visualizzare gli altri elementi.

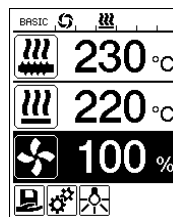



- La capacità di produzione può essere regolata mediante il **potenziometro (3)** in incrementi del 5% durante il processo di estrusione. La gamma spazia tra un min. del 35% fino alla max. capacità di produzione impostabile. Il valore impostato al momento è sempre visibile nella schermata del processo. Il valore impostato nella schermata del processo deve essere inteso come valore massimo. Il **Potenziometro (3)** consente di impostare solo valori fino a questo valore massimo. Questo valore è normalmente pari al 100%.
- Se la capacità di produzione minima (35%) è troppo alta, è necessario passare a un filo per saldatura dello spessore di 3 mm.
- Se la capacità di produzione massima (100%) è troppo bassa, è necessario passare a un filo per saldatura dello spessore di 4 mm.

Select Profile [Selezione profilo]

- Scelta di un profilo predefinito o personalizzabile
- La WELDPLAST S1 dispone di oltre sei profili Leister predefiniti e fino a dieci profili personalizzabili:

Profili di saldatura		Produzione Max. [%]	Temperatura di plastificazione nominale [°C / °F]	Nominale dell'aria Temperatura [°C / °F]	Quantità d'aria [%]
1	BASIC	regolabile	regolabile	regolabile	regolabile
2	PE-HD	100	230	260	100
3	PP	100	240	260	100
4	PVC-U	100	200	300	100
5	PVDF	100	250	320	100
6 – 16	profilo personalizzato	regolabile	regolabile	regolabile	regolabile

- Selezionando l'icona  nella **schermata funzioni (27)**, si raggiunge il menu “Selezione profilo”. È possibile selezionare uno dei sei profili predefiniti (1 – 6) o uno dei profili personalizzati (7 – 16) premendo i **pulsanti 21/22 “Su”**  e **“Giù”** .
- Se i valori nominali vengono modificati durante il funzionamento (profili 2 – 16), non verranno memorizzati nel profilo!
- Allo spegnimento o all'accensione della macchina, appariranno sempre gli stessi valori definiti nel profilo.
- Per utilizzare gli ultimi valori impostati alla riaccensione della macchina, selezionare il profilo BASIC (1).
- Il profilo selezionato è visibile nella parte sinistra della **schermata di stato “Campo 1” (29)**.

PE-HD 

Monitoraggio dei parametri di saldatura

- Le temperature di plastificazione e dell'aria correnti vengono monitorate costantemente. Se un valore reale si discosta dal rispettivo valore nominale, apparirà un avviso nella **schermata del processo (28)** (“Show Set Values” non attivato).

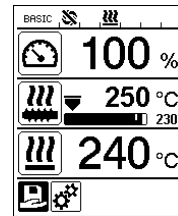
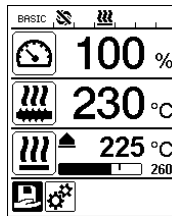
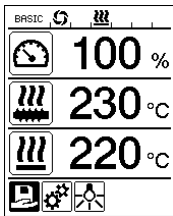

- Il valore reale è uguale al valore nominale.
- Valore reale della temperatura dell'aria troppo basso. Il processo di riscaldamento viene segnalato da un lampeggio (la freccia verso l'alto e la barra di progressione).
- Valore reale della temperatura di plastificazione troppo elevato. Il processo di raffreddamento viene segnalato da un lampeggio (la freccia verso il basso e la barra di progressione).

Sblocco motore

- Per lo sblocco del motore esistono quattro ritardi di azionamento diversi (vedere la tabella) che dipendono dalla temperatura di plastificazione reale e dalla temperatura di plastificazione nominale impostata. Il preriscaldamento dell'aria non ha alcun impatto sullo sblocco del motore.
- La soglia di sblocco corrisponde al momento in cui la temperatura di plastificazione reale diventa maggiore della temperatura nominale - 20 K.
- **Icona corrispondente nella schermata di stato:**



Motore bloccato





Motore sbloccato

Temperatura di plastificazione reale all'accensione del riscaldamento o regolazione della temperatura di plastificazione nominale	Temperatura di plastificazione nominale	Ritardo di sblocco al raggiungimento della soglia di sblocco
Temperatura di plastificazione nominale – 5K < Temperatura di plastificazione reale	—	Motore sbloccato direttamente
Temperatura di plastificazione nominale – 20K < Temperatura di plastificazione reale < Temperatura di plastificazione nominale – 5K	—	30 sec.
Temperatura di plastificazione nominale – 20K > Temperatura di plastificazione reale (AI di sotto della soglia di sblocco)	> 190°C	2 min. 30 sec
Temperatura di plastificazione nominale – 20K > Temperatura di plastificazione reale (AI di sotto della soglia di sblocco)	< 195°C	3 min. 30 sec

- Se la WELDPLAST S1 non è in grado di mantenere la temperatura di plastificazione reale a motore sbloccato per più di 10 sec., il motore verrà inibito nuovamente. Non appena l'apparecchio ha raggiunto nuovamente la soglia di sblocco, il motore viene sbloccato dopo il trascorrere di uno degli intervalli tabulari.

Blocco tasti





- Con una pressione simultanea di almeno due secondi dei pulsanti 21 / 22 “Su”  e “Giù”  è possibile attivare o disattivare il blocco tasti.

Interruzione dell'alimentazione





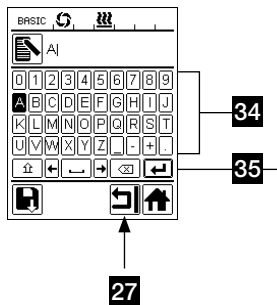

Stato del motore prima dell'interruzione	Durata dell'interruzione	Stato della WELDPLAST S1 dopo l'interruzione
Motore sbloccato Schermata del processo di saldatura	≤ 5 sec	L'apparecchio si avvia senza protezione di riavvio e passa direttamente allo stato di interruzione dell'alimentazione
Motore sbloccato (preriscaldamento dell'aria > 100 °C)	> 5 sec	L'apparecchio passa direttamente in modalità “Cool down modus” [Modalità raffreddamento]
Motore sbloccato (preriscaldamento dell'aria < 100 °C)	> 5 sec	L'apparecchio si avvia e sul Display (5) appare la schermata di inizio.

Immissione di nomi o password













- Mediante la modalità tastiera, è possibile definire nomi o immettere password di massimo 12 caratteri.

Funzione tastiera	Scelta carattere 34	Selezione icona 35
 	Su (21) Giù (22)	Scelta carattere verticalmente
 	Meno (24) Più (26)	Scelta carattere orizzontalmente Selezione delle icone
	Conferma (25)	Conferma del carattere scelto Conferma dell'icona selezionata



	Cambio Maiuscolo - minuscolo
 	Spostare la posizione del cursore all'interno del nome
	Inserimento spazio
	Cancellazione di un solo carattere (caratteri a sinistra del cursore)
	Scegliere questa icona per passare alla schermata funzioni 27

Definizione di profili

- Nel menu "Save Profile" [Salva profilo], è possibile salvare le impostazioni dei valori nominali: max. capacità di produzione, temperatura aria e plastificazione e portata d'aria con un nome a scelta (vedere capitolo "Immissione di nomi o password").
- **Creazione di un nuovo profilo:**
 - Nella **schermata del processo (28)**, impostare i valori nominali desiderati mediante i **pulsanti 24/26 "Più"  o "Meno" **.
 - Nella **schermata funzioni (27)**, utilizzando il **pulsante 26 "Più" **, selezionare il menu Impostazioni .
 - Nel menu "Setup" [Configurazione], effettuare la scelta con il **pulsante 26 "Più"  "Save Profile" [Salva profilo].**
 - Selezionare il profilo "User-defined" [Definito dall'utente] e confermare mediante il **pulsante (25) **.
 - Nella **schermata funzioni (27)**, selezionare l'icona  "Modificare la posizione selezionata" e confermare con il **pulsante (25) **.
 - Immettere il nome del profilo desiderato (vedere capitolo "Immissione di nomi o password"), quindi con il **pulsante 26 "Più"  selezionare l'icona  e confermare con il **pulsante (25) **.**
 - Nella **Schermata funzioni (27)** confermare l'icona selezionata "Salvataggio"  con il **pulsante (25) **.
Il profilo viene salvato con successo e selezionato.

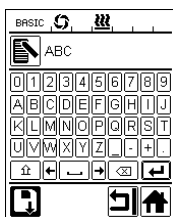
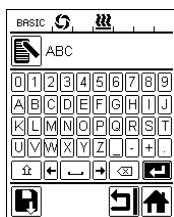
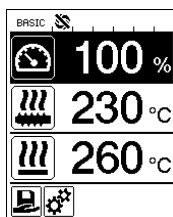

Definizione di profili

• Modifica di un profilo esistente (tranne i profili Leister):

- Nella **schermata del processo (28)**, impostare i valori nominali desiderati mediante i **pulsanti 24 / 26 “Più”** o **“Meno”** .
- Nella **schermata funzioni (27)**, utilizzando il **pulsante 26 “Più”** , selezionare il menu Impostazioni .
- Nel menu “Setup” [Configurazione], effettuare la scelta con il **pulsante 26 “Più”** “Save Profile” [Salva profilo].
- Selezionare il profilo da modificare e confermare mediante il **pulsante (25)** .
- Nella **schermata funzioni (27)**, selezionare l'icona “Modificare la posizione selezionata” e confermare con il **pulsante (25)** .
- Immettere il nome del profilo desiderato (vedere capitolo Immissione di nomi o password), quindi con il **pulsante 26 “Più”** selezionare l'icona e confermare con il **pulsante (25)** .
- Nella **Schermata funzioni (27)** confermare l'icona selezionata “Salvataggio” con il **pulsante (25)** . Il profilo viene salvato con successo e selezionato.

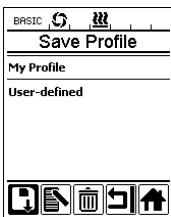
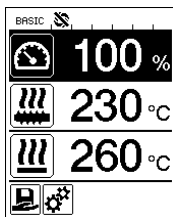





Impostazioni della macchina

Machine Setup	
Select Unit [Metric / Imperial]	metric
LED Mode	ON*
LCD Contrast	0
LCD Backlight	90 %
Key Backlight	50 %

Menu	Funzione
Select Unit [Seleziona unità]	Configurazione dell'unità utilizzata: – metrico/imperiale
LED Mode	<p>Modalità LED:</p> <p>– ON*: È possibile accendere la luce LED solo a motore sbloccato. Non appena il motore si sblocca, nella schermata funzioni (27) appare l'icona del LED . A questo punto è possibile scegliere se accendere o spegnere la luce LED. La modalità LED non viene modificata.</p> <p>– ON: La luce LED è sempre accesa. Nella schermata funzioni (27) compare l'icona LED . A questo punto è possibile scegliere se accendere o spegnere il LED. La modalità LED non viene modificata.</p> <p>– OFF: La luce LED è sempre spenta.</p>
LCD Contrast [Contrasto LCD]	Regolazione del contrasto LCD
LCD Backlight [Retroilluminazione LCD]	Regolazione della retroilluminazione del display
Key Backlight [Retroilluminazione tasti]	Regolazione della retroilluminazione della tastiera

Avvertenze e messaggi di errore

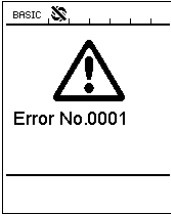
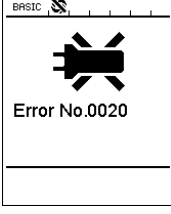
- Se compare un'avvertenza, l'utilizzatore può proseguire con il lavoro senza limitazioni. È possibile ottenere informazioni più precise relativamente all'avvertenza dalla **schermata funzioni (27)** nel menu impostazioni  alla voce "Show Warnings" [Mostra avvertenze].
- In caso di errore, l'apparecchio spegne tutti i riscaldatori e il motore non verrà più sbloccato.

Tipo di messaggio	Schermata	Codice di errore	Descrizione dell'errore
Avvertenza		—	Simbolo di avvertenza  nella schermata di stato (30) . I carboncini del motore devono essere sostituiti. Dopo la prima comparsa del simbolo di avvertenza, il motore può restare in servizio per altre 5 ore. Una volta trascorse, apparirà il messaggio di errore " Error No.0400 " [Errore N. 0400] e il motore non verrà più sbloccato.
Errore		0001	Sovratemperatura dell'apparecchio. Fare raffreddare l'apparecchio.
		0020	Guasto all'elemento riscaldante dell'aria.
Errore! Contattare il Leister Service Center		0004	Errore hardware.
		0008	Guasto alla termocoppia dell'aria.
		0010	Guasto alla termocoppia del Plast.
		0040	Guasto all'elemento riscaldante del Plast.
		0100	Guasto al soffiante.
		0200	Comunicazione di errore.
		0400	Carboncini del motore o sovratemperatura del motore.

Cambio di accessori



Pericolo di scottature!



Lavorare solo con guanti termoresistenti indossati.

Cambio del pattino di saldatura

• Smontaggio

- Spegnere l'apparecchio ancora caldo e scollegarlo dalla rete.
- Rimuovere il **pattino di saldatura (8)** allentando le **viti di fermo (18)** dall'**ugello estrusore (17)**.
- Pulire l'**ugello estrusore (17)** a ogni cambio del pattino di saldatura rimuovendo eventuali residui di materiale d'apporto e assicurarsi, che sia avvitato saldamente.

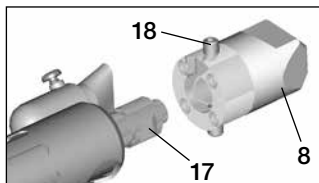

• Montaggio

- Fare scorrere un **pattino di saldatura (8)** adatto al filo per saldatura sull'**ugello estrusore (17)** e fissarlo serrando le **viti di fermo (18)**.

Cambio della condotta aria calda

• Smontaggio

- Allentare **lavite di fermo (33)**. La **condotta aria calda (16)** può essere rimossa o orientata verso la direzione di saldatura desiderata.
- Montare la **condotta aria calda (16)** corrispondente (vedere capitolo Direzione di saldatura).
- Fissare **lavite di fermo (33)**.

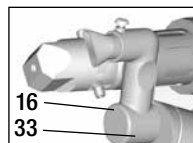

Cambio dell'ugello di preriscaldamento

• Smontaggio

- Allentare la **vite di fermo (19)** dell'**ugello di preriscaldamento (9)** ed estrarre l'**ugello di preriscaldamento (9)** dalla **condotta aria calda (16)**.

• Montaggio

- Fare scorrere l'**ugello di preriscaldamento (9)** sulla **condotta aria calda (16)**. Prestare attenzione all'orientamento parallelo con il **pattino di saldatura (8)**.
- Serrare la **vite di fermo (19)**.

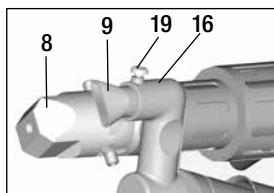

Direzione di saldatura

- Scegliere la condotta aria calda adatta alla direzione di saldatura scelta.

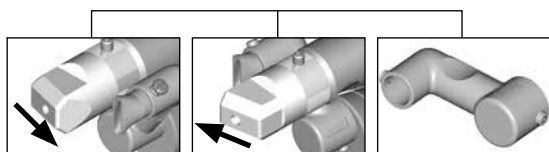

Direzione di saldatura

Condotta aria calda



Direzione di saldatura

Condotta aria calda

Accessori

- Per ragioni tecniche e di sicurezza, utilizzare esclusivamente accessori Leister.
- Accessori disponibili alla pagina www.leister.com

Tipi di pattini di saldatura

- Leister Technologies AG offre pattini di saldatura di varie misure, adatti a ogni tipo di filo per saldatura:

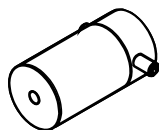

Pezzo grezzo

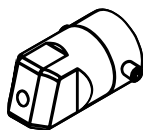

Saldatura a gola

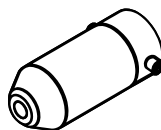

Saldatura d'angolo

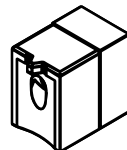







Saldatura a V

Condotta aria calda



Ugello di preriscaldamento

- La vasta scelta di pattini di saldatura permette di raggiungere un livello di preriscaldamento ottimale. Per questa ragione, Leister Technologies AG offre diversi tipi di ugelli di preriscaldamento.

Pattino di saldatura	Larghezza del filo per saldatura mm	Ugelli di preriscaldamento			
		 Larghezza 21 mm Lunghezza 26 mm	 Larghezza 2 mm Lunghezza 42 mm	 ∅ 14 mm Lunghezza 58 mm angolare	 ∅ 14 mm Lunghezza 46 mm
Saldatura a gola 	5 / 6			• (b)	•
	8 / 10			• (b)	•
	12			• (b)	•
Saldatura d'angolo 				• (b)	•
Saldatura a V 	3 / 4	•	• (a)		
	5 / 6	•	• (a)		
	8 / 10	•	• (a)		

a) Pattini di saldatura DVS come per WELDPLAST S2-PVC.

b) Ugello angolare per il preriscaldamento ottimale nelle operazioni di saldatura radiale tubi.

Manutenzione

- Controllare la presenza di guasti elettrici e meccanici nella linea di **allacciamento alla rete (13)** e nella spina elettrica.
- Eliminare i residui della saldatura dall'**ugello dell'estrusore (17)** ad ogni sostituzione del pattino di saldatu

Servizio di assistenza e riparazione

Le riparazioni devono essere eseguite esclusivamente dai **centri di assistenza tecnica Leister** autorizzati. I centri di assistenza garantiscono un **servizio di riparazione** professionale ed affidabile **entro 24 ore** con pezzi di ricambio originali conformi agli schemi elettrici e agli specifici elenchi.

- Qualora, in fase di accensione dell'apparecchio, sul display dell'apparecchio WELD-PLAST S1 venga visualizzata la dicitura «Maintenance servicing» [Tagliando di controllo], è necessario fare verificare e in ogni caso sostituire il motore di azionamento (collettore e carboncini) a cura di un punto assistenza Leister autorizzato. La dicitura cessa automaticamente di essere visualizzata trascorsi 10 secondi o può, in alternativa, essere immediatamente ignorata premendo il **pulsante (25)**  «**Conferma**».

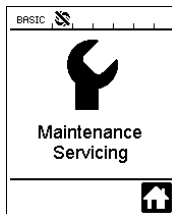

Garanzia legale

- A questo prodotto si applicano i diritti previsti per la garanzia concessi dal partner di distribuzione/rivenditore diretto, a partire dalla data di acquisto. In caso di ricorso alla garanzia (fanno fede la fattura o la bolla di consegna), sono previste la fornitura sostitutiva o la riparazione di difetti di fabbricazione o di lavorazione a cura del partner di distribuzione. La garanzia non si applica agli elementi riscaldanti.
- È esclusa qualsiasi ulteriore garanzia non espressamente prevista dalle vigenti norme di diritto cogente.
- Sono esclusi dalla garanzia i danni riconducibili alla naturale usura, al sovraccarico o alla scorretta manipolazione.
- Il ricorso alla garanzia decade per gli apparecchi sottoposti a modifiche o alterazioni da parte dell'acquirente.



Instrucciones de funcionamiento

(Traducción del manual de instrucciones original)



Lea las instrucciones de funcionamiento atentamente antes de la puesta en funcionamiento y consérvelas para el futuro.

Leister WELDPLAST S1 Extrusor manual para soldadura

Aplicación

- Soldadura por extrusión de los siguientes materiales
PP / PE-HD / PVC-U / PVC-C / PVDF
- Otros materiales a petición



Advertencia



Existe **peligro de muerte** al abrir el equipo, ya que se dejan al descubierto componentes y conexiones sometidos a tensión. Antes de abrir el equipo, desconecte el enchufe.



Peligro de fuego y explosiones en caso de un uso incorrecto de la extrusor manual para soldadura (por ejemplo, sobrecalentamiento del material), especialmente cerca de materiales inflamables y gases explosivos.



¡Peligro de quemaduras! No toque las piezas metálicas descubiertas ni la masa resultante si están calientes. Espere a que el equipo se enfríe. No dirija el chorro de aire caliente ni la masa resultante hacia personas o animales.



Conecte el equipo a un **enchufe con conductor de protección**. Las interrupciones en el conductor de protección, ya se produzcan dentro o fuera del equipo, son peligrosas.
¡Utilice únicamente un cable alargador con conductor de protección!



Precaución



La **tensión nominal** indicada en el dispositivo debe coincidir con la tensión de red. En caso de fallo de alimentación se debe desconectar el interruptor principal y el accionamiento (soltar el bloqueo).



Es **imprescindible un interruptor FI** para el empleo del equipo, a modo de protección personal.



Peligro de deslumbramiento Debe evitarse el contacto visual directo con el haz de luz LED. El equipo **debe permanecer vigilado** mientras esté funcionando. El calor puede llegar a materiales inflamables que se encuentren fuera del ámbito visual.

El aparato sólo podrá ser utilizado por **personal especializado debidamente formado** o bajo su vigilancia. Se prohíbe terminantemente su uso por parte de niños.



Proteger el aparato de la humedad y el agua.

Conformidad

Leister Technologies AG, Galileo-Strasse 10, CH-6056 Kaegiswil/Suiza declara que este producto, en la versión que hemos puesto en circulación, cumple los requisitos de las siguientes directivas de la CE.

Directivas:	2006/42, 2004/108 (hasta el 19.04.2016), 2014/30 (a partir del 20.04.2016), 2006/95 (hasta el 19.04.2016), 2014/35 (a partir del 20.04.2016), 2011/65
Normas armonizadas:	EN 12100, EN 55014-1, EN 55014-2, EN 61000-6-2, EN 61000-3-2, EN 61000-3-3, EN 62233, EN 60335-1, EN 60335-2-45, EN 50581

Kaegiswil, 04.02.2016

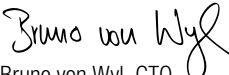
Bruno von Wyl, CTO

Andreas Kathriner, GM

Eliminación



Las herramientas eléctricas, los accesorios y los embalajes deben reciclarse y reutilizarse de forma adecuada para proteger el medio ambiente. **Solo para países de la Unión Europea:** No desechar jamás herramientas eléctricas en la basura doméstica..

Datos técnicos

Tensión	V~	100	120	230
Potencia	W	1500	1800	1600
Frecuencia	Hz	50/60	50/60	50/60
Temperatura del air	°C	max. 360		
Temperatura de plastificado	°C	max. 260		
Rendimiento (Ø 3 mm)	kg/h	HD-PE 0.2–0.5; PP 0.2–0.5		
Rendimiento (Ø 4 mm)	kg/h	HD-PE 0.3–0.8; PP 0.3–0.75		
Alambre para soldar	mm	Ø 3 / Ø 4		
Nivel de emisión	L _{pA} (dB)	76 (K = 3 dB)		
Masa L × An × Al	mm	435 × 264 × 91 (sin zapata de soldadura)		
Peso	kg	4.7 (sin cable de conexión de red)		
Marca de conformidad		CE	CE	CE
Símbolo de seguridad				⚠
Clase de protección I		⊥	⊥	⊥
Sujeto a modificaciones técnicas				

Descripción del equipo

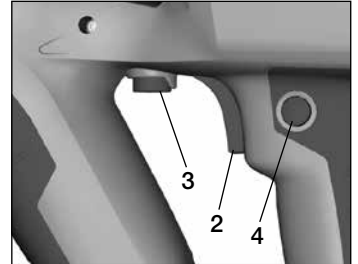
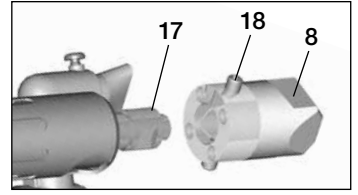
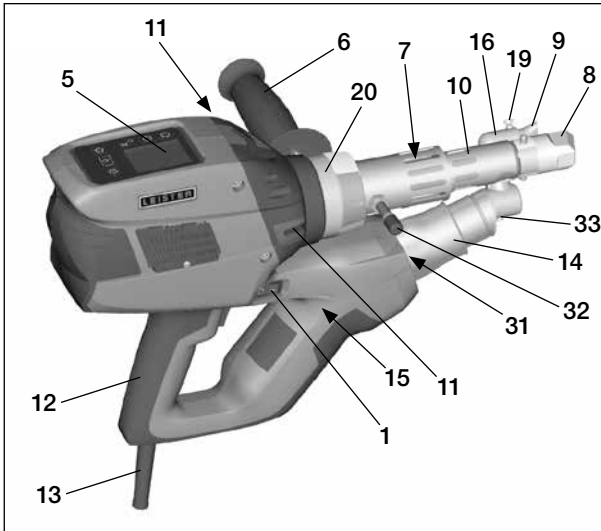

- | | |
|---------------------------------------------|----------------------------------------------------------|
| 1 Interruptor principal | 13 Cable de alimentación principal |
| 2 Interruptor On/Off del accionamiento | 14 Resistencia - tubo de protección |
| 3 Potenciómetro | 15 Soplador (sin escobilla) |
| 4 Dispositivo de sujeción del accionamiento | 16 Guía de aire caliente |
| 5 Pantalla | 17 Tobera de extrusión |
| 6 Mango | 18 Tornillo de sujeción de la zapata de soldadura |
| 7 Calefactor de recubrimiento | 19 Tornillo de sujeción de la tobera de precalentamiento |
| 8 Zapata de soldadura | 20 Abrazadera de sujeción |
| 9 Tobera de precalentamiento | 31 Iluminación LED |
| 10 Tubo de protección | 32 Perno de descarga |
| 11 Entrada del alambre para soldar | 33 Tornillo de sujeción de la guía de aire caliente |
| 12 Empuñadura del equipo | |

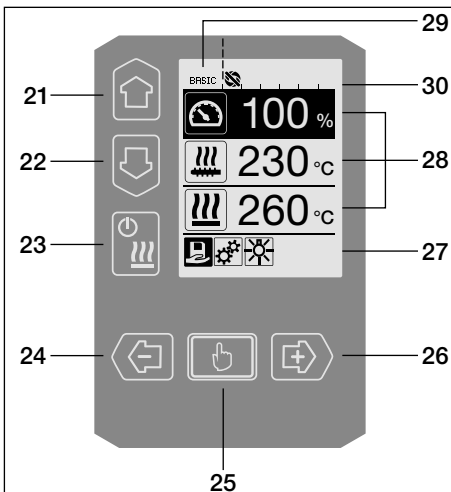





Unidad de manejo

- | |
|-------------------------------|
| 21 Tecla «Arriba» |
| 22 Tecla «Abajo» |
| 23 Tecla calefacción «On/Off» |
| 24 Tecla «Menos» |
| 25 Tecla «Confirmar» |
| 26 Tecla «Más» |

Pantalla





- | |
|----------------------------------|
| 27 Indicación de funciones |
| 28 Indicación de trabajo |
| 29 Indicación de estado «zona 1» |
| 30 Indicación de estado «zona 2» |

Descripción de manejo

Modo de teclado		Selección actual en la indicación de trabajo	Selección actual en la indicación de funciones
	Arriba (21) Abajo (22)	Modificación de la posición dentro de la indicación de trabajo	Cambio de la indicación de funciones a la indicación de trabajo
	Calefacción On/Off (23)	Sin función	Cambio del modo de soldadura al proceso de refrigeración Cambio del proceso de refrigeración al modo de soldadura Cambio de la indicación de inicio al modo de soldadura
	Menos (24) Más (26) (pulsar brevemente)	Ajuste del valor nominal deseado en pasos de 5 °C o 5 %.	Modificación de la posición dentro de la indicación de trabajo
	Menos (24) Más (26) (pulsar y mantener pulsado)	Ajuste del valor nominal deseado en pasos de 10 °C o 10 %.	Modificación de la posición dentro de la indicación de trabajo
	Confirmar (25)	El valor ajustado se acepta directamente y la selección vuelve a la indicación de funciones	Se ejecuta la función seleccionada

Descripción de pantalla

Indicación de estado «zona 1» (29)	
PE-HD	Perfil seleccionado actualmente. Si un nombre de perfil tiene más de 6 caracteres, se indican primero los 6 primeros y luego el resto de caracteres.
1 min 16 s	Tiempo restante hasta que se libere el accionamiento (1 min/16 s)

Indicación de estado «zona 2» (30)	
	Accionamiento liberado
	Accionamiento no liberado
	Hay una advertencia (escobillas de carbón/accionamiento)
	Bloqueo de teclado (solo aparece si el bloqueo de teclado está activado)
	Calefacción de aire y plastificado conectada

Indicación de funciones y trabajo

- En la indicación de funciones y en la de trabajo el campo o símbolo que aparece marcado es siempre el que define la selección actual.
- En la indicación de trabajo se muestran siempre los valores reales, a no ser que haya seleccionada una posición, en ese caso se muestra el valor nominal.
- Si «Show Set Values» (mostrar valores ajustados) está activado, aparece el valor real y el nominal (en pequeño).

Indicación de funciones (27)	
	Seleccionar perfiles libre y preconfigurados
	Ajustes
	Volver a la indicación de trabajo (salir directamente de un menú)
	Conectar/desconectar LED. Esta función solo está disponible si se ha activado el LED.
	Volver un nivel
	Restablecer ajustes o contador de horas
	Menú de servicio (solo disponible con contraseña)
	Guardar
	Borrar posición seleccionada
	Editar posición seleccionada
	Introducir el proceso de refrigeración

Indicación de trabajo (28)	
	Valor nominal: Cantidad de expulsión del accionamiento [%]
	Valor nominal: Temperatura de plastificado [°C / °F]
	Valor nominal: Temperatura del aire [°C / °F]
	Valor nominal: Flujo de aire [%]
	Ventana de información
	La flecha hacia arriba y la barra de progreso indican que el valor nominal (marca en la barra de progreso) aún no se ha alcanzado (demasiado frío). El valor que parpadea es el valor real. El valor al lado de la barra de progreso es el valor nominal ajustado.
	La flecha hacia abajo y la barra de progreso indican que el valor nominal (marca en la barra de progreso) aún no se ha alcanzado (demasiado caliente). El valor que parpadea es el valor real. El valor al lado de la barra de progreso es el valor nominal ajustado.
	Si « Show Set Values » (mostrar valores ajustados) está activado, se indica la temperatura real (en grande) y la temperatura nominal (en pequeño).
	Proceso de refrigeración
	Equipo en modo Stand by. El equipo iniciará el « Cool down mode » (modo de refrigeración) cuando finalice la cuenta atrás
	El equipo tiene un error. De forma adicional aparece un código de error (el equipo ya no está listo para el funcionamiento). Póngase en contacto con un centro de servicio autorizado
	Avería de resistencia para el aire
	Temperatura del equipo demasiado alta. Deje que el equipo se enfríe.

Vista general de la indicación de trabajo

Indicación de inicio

Indicación inicial con la versión de software de la unidad de rendimiento.



Cool down mode (modo de refrigeración) (refrigeración)

En este modo las calefacciones están desconectadas y el equipo se encuentra en el modo de refrigeración. Si al conectar el equipo la temperatura del aire del precalentamiento es mayor de 100 °C, el equipo cambia automáticamente al «Cool down mode» (modo de refrigeración). Este proceso finalizará en cuanto la temperatura del aire de precalentamiento se mantenga durante 2 min por debajo de 100 °C.

Si desea volver a conectar las calefacciones debe pulsar la **tecla (23)** «Calefacción On/Off» o la **tecla (25)** «Confirmar»

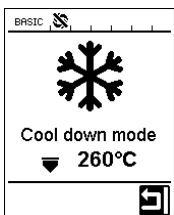

Maintenance servicing (servicio de mantenimiento)

Si ha transcurrido el intervalo de mantenimiento del motor de accionamiento, después de la indicación de inicio aparecerá «Maintenance Servicing» (servicio de mantenimiento). Mediante la **tecla (25)** «Confirmar» podrá seguir trabajando. Debe llevar al equipo a su centro de servicio urgentemente.



Indicación inicial

En la indicación inicial se muestran todos los valores nominales. La calefacción aún no está conectada, pero ya se pueden ajustar todos los valores nominales.

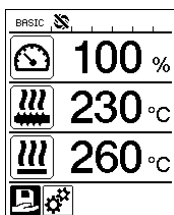

Indicación de inicio de soldadura

Indicación durante el proceso de calentamiento

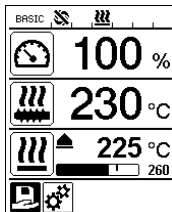

Select Profile (selección de perfil)

Seleccione un perfil definido por usted o indicado por Leister. La selección de perfil se describe de forma detallada en el capítulo «Select Profile» (selección de perfil), página 89.

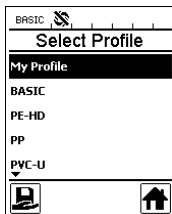

Setup (ajustes)

En los ajustes básicos puede acceder a través del menú «Setup» (Ajustes) a la función para guardar el perfil y la función de Stand by. Si selecciona el «Advanced Mode» (Modo avanzado) estarán disponibles diversas opciones de ajuste adicionales.

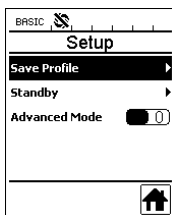

Save profile (definir perfiles libres)

El guardado de perfiles libres se describe de forma detallada en el capítulo «Definir perfiles», página 91/92.



Vista general de la indicación de trabajo

Standby (modo de espera)

Si el modo Stand by está activado y no se pulsa ninguna tecla en la unidad de manejo durante el tiempo establecido en «**Standby Interval**» o se acciona el **interruptor accionamiento On/Off (2)** el equipo cambia automáticamente a la indicación Stand by. Si en los siguientes 180 s no se pulsa la **tecla (25)**  «**Confirmar**», se inicia automáticamente el modo de refrigeración.

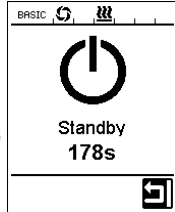
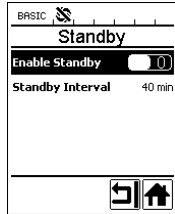

Duty Info

Hours Drive: tiempo de funcionamiento actual del accionamiento (se puede reiniciar).

Hours Blower: tiempo de funcionamiento actual de los sopladores.

Hours Machine: tiempo de funcionamiento actual de la máquina.

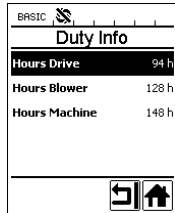

General Info

Firmware HMI: versión de software de la unidad de pantalla (módulo de comunicación).

Firmware de la máquina: versión de software de la unidad de rendimiento.

Production Info: indicaciones acerca del momento de la producción.

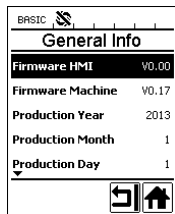

Warnings

Si hay una advertencia se señala en la indicación de estado mediante el símbolo . En el menú «Warnings» encontrará indicaciones más específicas acerca de la advertencia.

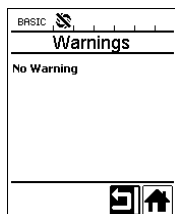

Machine Setup

Los ajustes de la máquina se describen detalladamente en el capítulo «Ajustes de la máquina».

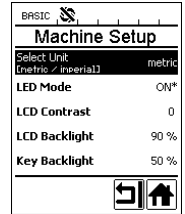

Application Mode (modo de aplicación)

Si el «Application Mode» (modo de aplicación) está activado, podrá encontrar indicaciones detalladas acerca de la temperatura real de plastificado y la ocupación de los sopladores de aire caliente y la calefacción de plastificado.



Plast: 80 % 222 °C
Heat: 40 % 197 °C
Amb.: 25 °C
Mains: 50 Hz

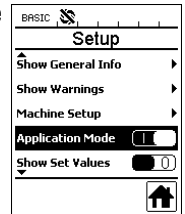

Si «Show Set Values» (mostrar valores ajustados) está activado, se indica la temperatura real (en grande) y la temperatura nominal (en pequeño).

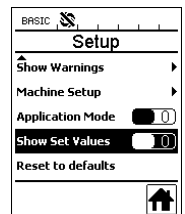

Reset to defaults (restablecer a valores por defecto)

Si selecciona el menú «Reset to defaults» (restablecer a valores por defecto) y lo confirma seleccionando la función , se borrarán todos los perfiles específicos de cliente. Los ajustes que se hayan modificado a través del menú de configuración serán restablecidos a su nivel de fábrica.

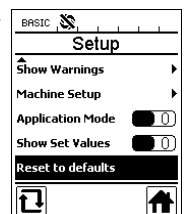

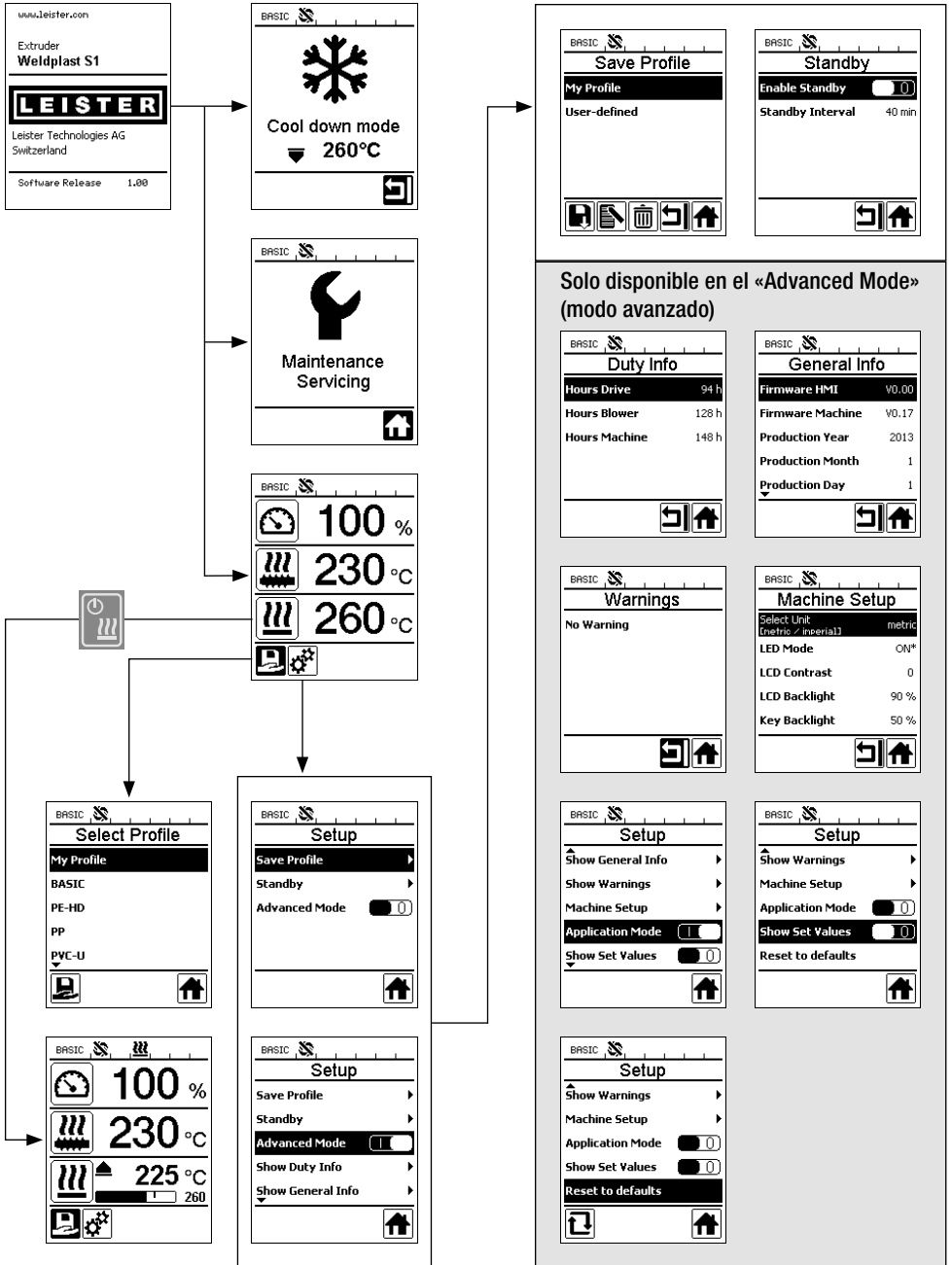



Antes de la puesta en marcha, comprobar si el cable de conexión a red (13) o el enchufe así como el cable alargador presentan algún daño eléctrico o mecánico.

La extrusor manual para soldadura no puede emplearse en entornos con peligro de explosiones o incendio. Garantice siempre un trabajo seguro. El cable de conexión de red y el alambre para soldar deben poder moverse con libertad y no dificultar el trabajo del usuario ni de un tercero.

La extrusor manual para soldadura debe colocarse sobre una superficie incombustible. Debe haber una distancia suficiente entre las piezas de metal calientes, el chorro de aire caliente, la base y las paredes.

Lugar de trabajo



Para poner en funcionamiento y depositar el extrusor manual para soldadura, Leister ofrece un **soporte**.

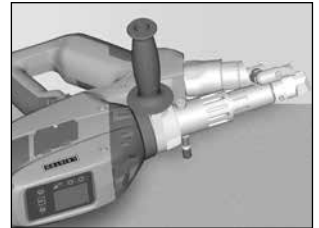
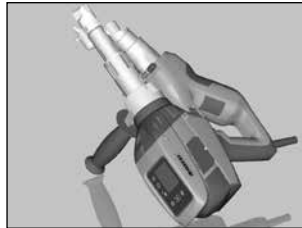

Al interrumpir los trabajos de soldadura, el accionamiento debe desconectarse con el **interruptor on/off del accionamiento (2)**. Como indica la figura, el extrusor manual para soldadura debe colocarse con el **mango (6)** correctamente ajustado y fijado sobre una base o un **perno de soporte (32)**.

Mango

Ajuste del mango

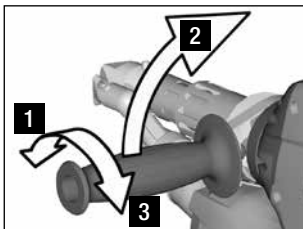

- 1** Afloje la sujeción del **mango (6)** girándolo en sentido contrario a las agujas del reloj.
- 2** Coloque el **mango (6)** en la posición de trabajo deseada.
- 3** Vuelva a apretar la fijación del **mango (6)** girándolo en el sentido de las agujas del reloj.

Montaje/desmontaje del mango

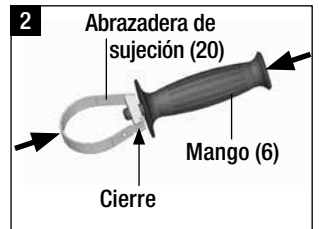
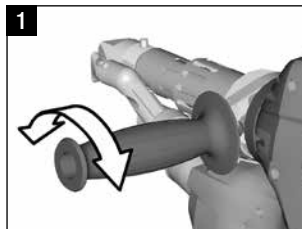

Peligro de quemaduras. Deje que el equipo se enfríe.

Desmontaje de la empuñadura

- 1** Afloje la sujeción del **mango (6)** girándolo en sentido contrario a las agujas del reloj.
- 2** Ejerciendo presión sobre el **mango (6)** y sobre la **abrazadera de sujeción (20)** se abre el **cierre** (véase las flechas). Retire el **mango (6)** con la **abrazadera de sujeción (20)**.

El montaje del mango se realiza en el orden inverso.

Cable alargador

- Si se utilizan cables alargadores, se debe tener en cuenta la sección transversal mínima:
- El cable alargador debe estar autorizado para su uso en el lugar de utilización (p. ej., en exteriores) y estar identificado como corresponda.
- Si se utiliza un grupo para el suministro de energía, su potencia nominal deberá ser el doble de la de la extrusor manual para soldadura.

Longitud [m]	Sección transversal mínima (a 100 – 230V~) [mm ²]
Hasta 19	2.5
20 – 50	4.0

Conexión del equipo

- Según desee, monte la **zapata de soldadura (8) correspondiente**, la **tobera de precalentamiento (9) adecuada**, así como la **guía de aire caliente (16)** (Cambio de accesorios, pág. 94).



Conecte el equipo a la tensión nominal. La tensión nominal, indicada en el equipo, debe coincidir con la tensión de red.

- Conecte la extrusora a través del **interruptor principal (1)**. Según la temperatura del aire de precalentamiento en la **pantalla (5)** aparece la indicación de inicio «Cool down mode» (modo de refrigeración). Si pulsa la **tecla (23) «Calefacción On/Off»** , se inicia el proceso de precalentamiento.
- Si el equipo está listo para el funcionamiento, la **iluminación LED (31)** se enciende de forma automática (ajuste de fábrica).
- Mediante el **interruptor On/Off del accionamiento (2)** puede conectar el accionamiento.

Proceso de soldadura

- Inserte el alambre para soldar (Ø 3 o 4 mm) en la **entrada del alambre para soldar (11)**.
- El alambre es absorbido de forma automática por la **entrada del alambre para soldar (11)**. El alambre debe desplazarse sin resistencia.



ATENCIÓN

Utilice el equipo siempre con alambre para soldar pero nunca inserte alambre en ambas entradas a la vez.

- Mediante el **potenciómetro (3)** puede ajustar la velocidad de absorción del alambre para soldar.
- Interrumpa la alimentación de masa con el **interruptor On/Off del accionamiento (2)**.
- Posicione la **tobera de precalentamiento (9)** sobre la zona de soldadura.
- Precaliente la zona de soldadura con movimientos oscilantes.
- Coloque el equipo sobre la zona de soldadura preparada y vuelva a accionar el **interruptor On/Off del accionamiento (2)**.
- Realice la soldadura de prueba según las indicaciones del fabricante del material y las normas o directivas nacionales. Revise la soldadura de prueba.
- Ajuste la cantidad de expulsión, el flujo de aire y el ajuste de temperatura si lo considera necesario (véase el capítulo «Ajuste de parámetros de soldadura», página 88).
- Para procesos de soldadura de larga duración puede mantener el **interruptor On/Off del accionamiento (2)** activado de forma duradera mediante el **dispositivo de sujeción del accionamiento (4)**.

ATENCIÓN

- PVC-U y PVC-C se procesan en el menú de PVC-U.
- Para evitar daños de corrosión a la hora de procesar PVC-U, PVC, C, ECTFE, PVDF, etc., recomendamos enjuagar la extrusora de mano con HD-PE al finalizar las tareas de soldadura.





Desconexión del equipo

- Afloje el dispositivo de sujeción del accionamiento (4) y suelte el interruptor On/Off del accionamiento (2).
- Retire el material de soldadura de la zapata de soldadura (8).
- Si pulsa la **tecla (23) «Calefacción On/Off»**  y la **tecla (25) «Confirmar»** la calefacción se desconecta y el equipo inicia el proceso de refrigeración «Cool down mode» (modo de refrigeración).
- Después del proceso de refrigeración el soplador se desconecta de forma automática y en la **pantalla (5)** se visualiza la indicación inicial.
- **Desconecte** el interruptor principal (1).



Desconecte el cable de alimentación de la red.

Ajuste de un parámetro

- Si es necesario modificar una indicación de valor nominal (p.ej. la temperatura nominal del plástico), puede seleccionar el valor nominal correspondiente mediante las **teclas 21/22 «Arriba»**  o **«Abajo»** . Mientras el valor nominal aparece marcado, se puede modificar a través de las **teclas 24/26 «Más»**  o **«Menos»** . En el WELDPLAST S1 se pueden ajustar cuatro valores nominales:



cantidad de expulsión (expulsión máxima si el potenciómetro está en el nivel 5, o se ha ajustado al 100 %).



Temperatura de plastificado





Temperatura de aire

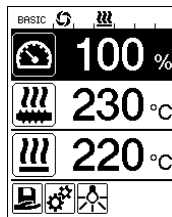

Flujo de aire

- En la indicación de trabajo se pueden mostrar como máximo tres elementos.



- Puede acceder a más elementos pulsando las **teclas 21/22 «Arriba»**  o **«Abajo»** .

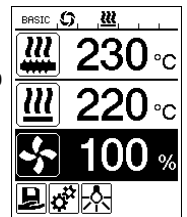



- Durante la extrusión puede ajustar la cantidad de expulsión en pasos de 5 % a través del **potenciómetro (3)**. El rango de ajuste oscila entre el 35 % como mínimo y la cantidad de expulsión máxima ajustada. El valor actual ajustado siempre se indica de forma visible en la indicación de trabajo. El valor ajustado en la indicación de trabajo debe entenderse como valor máximo. Con el **potenciómetro (3)** solo podrá ajustar hasta ese valor máximo. Por ello, por defecto este valor viene ajustado a 100 %.
- Si aún con la expulsión mínima (35 %) la expulsión es demasiado elevada, debe cambiar al grosor de alambre para soldar de 3 mm.
- Si aún con la expulsión máxima (100 %) la expulsión es demasiado baja, debe cambiar al grosor de alambre para soldar de 4 mm.

Select Profile (selección de perfil)

- Selección de un perfil predefinido o libre
- La WELDPLAST S1 cuenta con seis perfiles predefinidos por Leister y hasta diez perfiles libremente configurables:

Perfiles de soldadura		Expulsión máx. [%]	Temperatura nominal de plastificado [°C/°F]	Temperatura nominal del aire [°C/°F]	Flujo de aire [%]
1	BASIC	ajustable	ajustable	ajustable	ajustable
2	PE-HD	100	230	260	100
3	PP (polipropileno)	100	240	260	100
4	PVC-U (policloruro de vinilo no plastificado)	100	200	300	100
5	PVDF (polifluoruro de vinilideno)	100	250	320	100
6 – 16	perfiles libres	ajustable	ajustable	ajustable	ajustable

- Si selecciona el símbolo  en la **indicación de funciones (27)** llegará al menú «Select Profile» (seleccionar perfil). Puede seleccionar uno de estos perfiles predefinidos (1 - 6) o un perfil libre específico de cliente (7 - 16) con las **teclas 21/22 «Arriba»**  y **«Abajo»** .
- Si modifica valores nominales (perfiles 2 - 16) durante el funcionamiento, estos no se guardarán en el perfil.
- Si se desconecta/conecta la máquina siempre vuelven a aparecer los valores definidos en el perfil.
- Si desea emplear los últimos valores usados al reconectar la máquina, debe seleccionar el perfil BASIC (1).
- Puede consultar el perfil seleccionado actualmente en la **«zona 1» de la indicación de estado (29)**.



Supervisión de los parámetros de soldadura

- La temperatura de plastificado y de aire actuales se supervisan de forma constante. Si un valor real difiere del valor nominal correspondiente, se indicará en la **indicación de trabajo (28)** («Show Set Values» (mostrar valores ajustados) no activado).

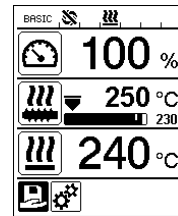
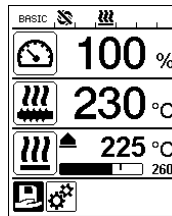
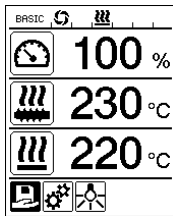

- El valor real se corresponde con el valor nominal.
- El valor real de la temperatura de aire es demasiado bajo. El proceso de calefacción se señala parpadeando (flecha hacia arriba y barra de progreso).
- El valor real de temperatura de plastificado es demasiado alto. El proceso de refrigeración se señala parpadeando (flecha hacia abajo y barra de progreso).

Liberación del accionamiento

- para la liberación del accionamiento existen cuatro tiempos de espera distintos (véase la tabla). Estos dependen de la temperatura real de plastificado y de la temperatura nominal de plastificado. El aire de precalentamiento no influye en la liberación del accionamiento.
- La zona de liberación empieza en cuanto la temperatura real de plastificado sea mayor que la temperatura nominal, 20 K.
- **Símbolo correspondiente en la indicación de estado:**



El accionamiento no está liberado



Accionamiento liberado

Temperatura real de plastificado al conectar la calefacción o al modificar la temperatura nominal de plastificado	Temperatura nominal de plastificado	Tiempo de liberación después de alcanzar la zona de liberación
Temperatura nominal de plastificado – 5 K < temperatura real de plastificado	—	El accionamiento se libera directamente
Temperatura nominal de plastificado – 20 K < temperatura real de plastificado < temperatura nominal de plastificado – 5 K	—	30 s.
Temperatura nominal de plastificado – 20 K < temperatura real de plastificado (por debajo de la zona de liberación)	> 190 °C	2 min 30 s
Temperatura nominal de plastificado – 20 K < temperatura real de plastificado (por debajo de la zona de liberación)	> 195 °C	3 min 30 s

- Si con el accionamiento liberado la WELDPLAST S1 no es capaz de mantener la temperatura real de plastificado durante más de 10 s en la zona de liberación, el accionamiento se vuelve a bloquear. En cuanto el equipo vuelva a alcanzar la zona de liberación, el accionamiento se liberará nuevamente después de un tiempo especificado en la tabla.

Bloqueo de teclado

- El bloqueo de teclado se activa o desactiva pulsando durante al menos dos segundos las **teclas 21/22 «Arriba»**



y **«Abajo»**







de forma simultánea.

Interrupción de suministro de corriente





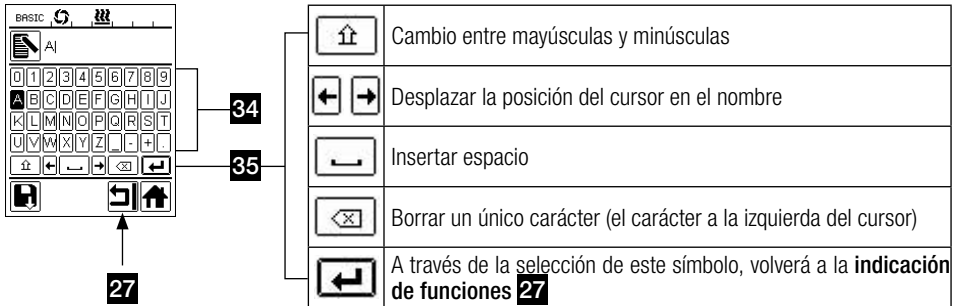

Estado del accionamiento antes de la interrupción	Duración de la interrupción	Estado de WELDPLAST S1 después de la interrupción
Accionamiento liberado, indicación de trabajo: soldadura	≤ 5 s	El equipo vuelve a conectarse sin protección de rearmado y cambia directamente al estado previo a la interrupción del suministro de corriente
Accionamiento liberado (aire de precalentamiento > 100 °C)	> 5 s	El equipo cambia directamente al «Cool down mode» (modo de refrigeración)
Accionamiento liberado (aire de precalentamiento < 100 °C)	> 5 s	El equipo arranca y en la pantalla (5) aparece la indicación de inicio.

Introducción de nombres o contraseñas

- A través del modo de teclado se pueden establecer nombres o introducir contraseñas con un máximo de 12 caracteres.

Modo de teclado	Selección de caracteres 34	Selección de símbolos 35
 	Arriba (21) Abajo (22)	Selección vertical de caracteres
 	Menos (24) Más (26)	Selección horizontal de caracteres
	Confirmar (25)	Confirmar el símbolo seleccionado















	Cambio entre mayúsculas y minúsculas
 	Desplazar la posición del cursor en el nombre
	Insertar espacio
	Borrar un único carácter (el carácter a la izquierda del cursor)
	A través de la selección de este símbolo, volverá a la indicación de funciones 27

Definición de perfiles

- En el menú «Save Profile» (Guardar perfil) puede guardar ajustes de valores nominales máximos de la cantidad de expulsión, la temperatura de plastificado, la temperatura de aire y del flujo de aire con un nombre definido por usted (véase el capítulo «Introducción de nombres y contraseñas»).





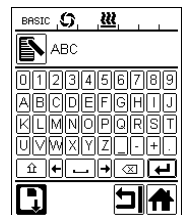
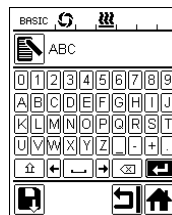
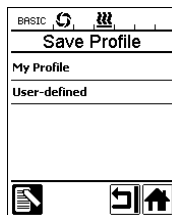
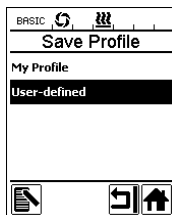
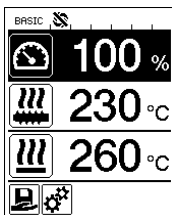







Creación de un perfil nuevo:

- Ajuste los valores nominales deseados en la **indicación de trabajo (28)** mediante las **teclas 24/26 «Más»**  o **«Menos»** .
- Seleccione en la **indicación de funciones (27)** con la **tecla 26 «Más»**  el menú Ajustes .
- En el menú «Setup» (Ajustes) seleccione la elección con la **tecla 26 «Más»**  «Save Profile» (Guardar perfil).
- Seleccione el perfil «User-defined» (definido por el usuario) y confirme mediante la **tecla (25)** .
- Seleccione en la **indicación de funciones (27)** el símbolo  «Editar posición seleccionada» y confirme mediante la **tecla (25)** .
- Introduzca el nombre de perfil deseado (véase el capítulo «Introducción de nombres o contraseñas»), a continuación seleccione con la **tecla 26 «Más»**  el símbolo  y confirme mediante la **tecla (25)** .
- Confirme en la **indicación de funciones (27)** el símbolo «Guardar» seleccionado  mediante la **tecla (25)** . El perfil se ha seleccionado y guardado de forma satisfactoria.



Definición de perfiles

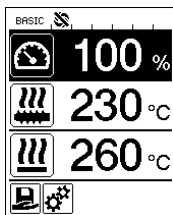

• Edición de un perfil existente (no aplicable a los perfiles de Leister):

- Ajuste los valores nominales deseados en la **indicación de trabajo (28)** mediante las **teclas 24/26 «Más»**  o **«Menos»** .
- Seleccione en la **indicación de función (27)** con la **tecla 26 «Más»**  el menú **Ajustes** .
- En el menú «Setup» (Ajustes) seleccione la elección con la **tecla 26 «Más»**  «Save Profile» (Guardar perfil).
- Seleccione el perfil que desee editar y confirme mediante la **tecla (25)** .
- Seleccione en la **indicación de funciones (27)** el símbolo  «Editar posición seleccionada» y confirme mediante la **tecla (25)** .
- Introduzca el nombre de perfil deseado (véase el capítulo Introducción de nombres o contraseñas), a continuación seleccione con la **tecla 26 «Más»**  el símbolo  y confirme mediante la **tecla (25)** .
- Confirme en la **indicación de funciones (27)** el símbolo «Guardar» seleccionado  mediante la **tecla (25)** . El perfil se ha seleccionado y guardado de forma satisfactoria.



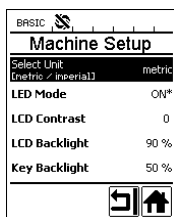

Ajustes de máquina



Menú	Función
Select Unit	Ajuste de la unidad empleada: – métrica/imperial
LED Mode	<p>Modo LED:</p> <p>– ON*: La iluminación LED solo se puede conectar si el accionamiento está liberado. En cuanto el accionamiento se haya liberado, aparece el símbolo LED  en la indicación de funciones (27). A través de este símbolo puede conectar/desconectar la iluminación LED si lo desea. El modo LED no se alterará.</p> <p>– ON: La iluminación LED está siempre conectada. En la indicación de funciones (27) aparece el símbolo LED . A través de este símbolo puede conectar/desconectar la iluminación LED si lo desea. El modo LED no se alterará.</p> <p>– OFF: La iluminación LED está siempre desconectada.</p>
LCD Contrast	Ajuste del contraste de la pantalla
LCD Backlight	Ajuste de la iluminación de fondo de la pantalla
Key Backlight	Ajuste de la iluminación de fondo del teclado

Advertencias y mensajes de error

- Si hay una advertencia, el usuario puede seguir trabajando sin limitación alguna. Puede consultar más información acerca de la advertencia a través de la **indicación de funciones (27)** en el menú Ajustes  en «Show Warnings» (mostrar advertencias).
- Si ocurre un error, el equipo desconecta todas las calefacciones y el accionamiento no se liberará más.

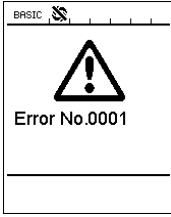
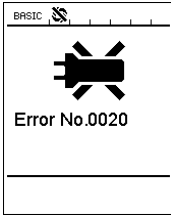
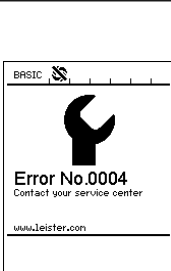
Tipo de mensaje	Indicación	Código de error	Descripción de error
Advertencia		—	Símbolo de advertencia  en la indicación de estado (30) . Es necesario sustituir las escobillas del accionamiento. Desde el momento en el que aparece el símbolo de advertencia por primera vez, el accionamiento aún puede seguir funcionando durante 5 h. Transcurrido ese plazo, aparecerá el mensaje de error « Error No.0400 » y el accionamiento no podrá ser liberado.
Error		0001	Sobretemperatura del equipo. Deje que el equipo se enfríe.
		0020	La resistencia para el aire está defectuosa.
Error Póngase en contacto con el centro de asistencia de Leister		0004	Error en el hardware.
		0008	El elemento térmico del aire está defectuoso.
		0010	El elemento térmico del plástico está defectuoso.
		0040	La resistencia del plástico está defectuosa.
		0100	El soplador está defectuoso.
		0200	Error de comunicación.
0400	Escobillas del accionamiento o sobretemperatura del accionamiento.		

Cambio de accesorios



Peligro de quemaduras.



No trabaje sin usar guantes termorresistentes.

Cambio de la zapata de soldadura

• Desmontaje

- Desconecte el equipo con temperatura de funcionamiento y desenchúfelo de la red eléctrica.
- Retire la **zapata de soldadura (8)** de la **tobera de extrusión (17)** aflojando los **tornillos de sujeción (18)**.
- Asegúrese de limpiar la **tobera de extrusión (17)** de restos de soldadura antes de cada cambio de zapata de soldadura y de que está bien atornillada.

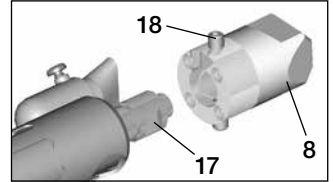

• Montaje

- Coloque una **zapata de soldadura (8)** adaptada al cordón de soldadura sobre la **tobera de extrusión (17)** y fíjela apretando los **tornillos de sujeción (18)**.

Cambio de la guía de aire caliente

• Desmontaje

- Afloje el **tornillo de sujeción (33)**. La **guía de aire caliente (16)** se puede retirar o girar hacia la dirección de soldadura deseada.
- Monte la **Guía de aire caliente (16)** correspondiente (véase el capítulo Dirección de soldadura).
- Apriete el **tornillo de sujeción (33)**.

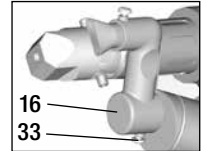

Cambio de la tobera de precalentamiento

• Desmontaje

- Afloje en la **tobera de precalentamiento (9)** el **tornillo de sujeción (19)** y retire la **tobera de precalentamiento (9)** de la **guía de aire caliente (16)**.

• Montaje

- Deslice la **tobera de precalentamiento (9)** sobre la **guía de aire caliente (16)**. Asegúrese de que esté alineada de forma paralela a la **zapata de soldadura (8)**.
- Apriete el **tornillo de sujeción (19)**.

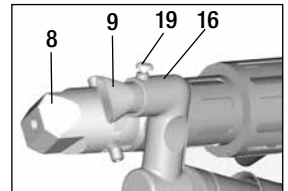

Dirección de soldadura

- La guía de aire caliente adecuada para la dirección de soldadura seleccionada.

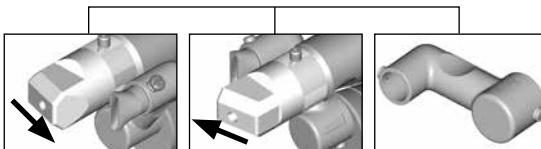

Dirección de soldadura

Guía de aire caliente



Dirección de soldadura

Guía de aire caliente

Accesorios

- Por razones técnicas y de seguridad solo está autorizado el uso de accesorios Leister.
- Accesorios en www.leister.com

Surtido de zapatas de soldadura

- Leister Technologies AG ofrece zapatas de soldadura adecuadas para todas las formas de costura habituales y en distintos tamaños:

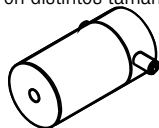

Pieza en bruto

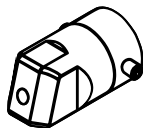

Costura de garganta



Soldadura de esquina

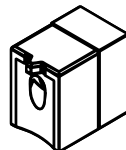







Costura en V

Guía de aire caliente



Tobera de precalentamiento

- Para que con la enorme selección de zapatas de soldadura pueda alcanzar un precalentamiento óptimo, Leister Technologies AG ofrece distintas toberas de precalentamiento.

Zapata de soldadura	Anchura de la costura de soldadura mm	Toberas de precalentamiento			
		 Anchura 21 mm Longitud 26 mm	 Anchura 21 mm Longitud 42 mm	 ∅ 14 mm Longitud 58 mm inclinado	 ∅ 14 mm Longitud 46 mm
Costura de garganta 	5/6			• (b)	•
	8/10			• (b)	•
	12			• (b)	•
Soldadura de esquina 				• (b)	•
Costura en V 	3/4	•	• (a)		
	5/6	•	• (a)		
	8/10	•	• (a)		

a) Zapatas de soldadura DVS iguales a las de WELDPLAST S2-PVC.

b) Tobera de precalentamiento inclinada para un precalentamiento óptimo en soldaduras radiales de tubos.

Mantenimiento

- Controlar que el **cable de conexión de red (13)** y el enchufe no tengan daños mecánicos ni eléctricos
- Retirar los restos de soldadura de la **boquilla de extrusión (17)** en cada cambio de zapata de soldadura

Servicio y reparaciones

- Las reparaciones se realizarán únicamente en **oficinas de servicio técnico autorizadas por Leister**. Estas garantizan un **servicio de reparación** fiable y especializado **durante 24 horas** con piezas de repuesto originales conforme a los planos de conexiones y las listas de piezas de repuesto.
- Si en WELDPLAST S1 aparece la indicación «Maintenance servicing» al conectar el equipo, el motor de accionamiento (colector y escobillas) debe ser revisado y, en todo caso, sustituido por un centro de servicio autorizado de Leister. Esta indicación desaparecerá automáticamente tras 10 segundos o puede omitirse pulsando la tecla  (25) «Confirmar».

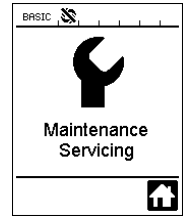

Garantía

- Para este dispositivo tienen validez los derechos de garantía comercial o legal concedidos por el socio de distribución directo/el vendedor a partir de la fecha de compra. En caso de que exista derecho de garantía comercial o legal (certificación mediante factura o albarán de entrega), el socio de distribución subsanará los daños de fabricación o tratamiento con una entrega de reposición o una reparación. Las resistencias están excluidas de la garantía.
- Cualquier otro derecho de garantía comercial o legal se excluirá en el marco del derecho imperativo.
- Los daños provocados por el desgaste natural del equipo, sobrecarga o manejos inadecuados quedan excluidos de la garantía.
- No habrá ningún derecho de garantía comercial o legal en el caso de los dispositivos que hayan sido alterados o modificados por el comprador.



Bedieningshandleiding vóór de inwerkingstelling aandachtig lezen en voor later gebruik bewaren.

Leister WELDPLAST S1 Hand-lasextruders

Toepassing

- Extrusielassen met de volgende materialen:
PP / PE-HD / PVC-U / PVC-C / PVDF
- Verdere materialen op aanvraag



Waarschuwing



Levensgevaar bij het openen van het apparaat, omdat onder spanning staande onderdelen en aansluitingen worden blootgelegd. Vóór het openen van het apparaat eerst de stekker uit het stopcontact trekken.



Brand- en ontploffingsgevaar bij ondeskundig gebruik van de hand-lasextruders (b.v. oververhitting van materiaal) vooral in de buurt van brandbare materialen en explosieve gassen.



Verbrandingsgevaar ! Blanke metaalvlakken en naar buiten stromende massa niet in hete toestand aanraken. Het apparaat eerst laten afkoelen. Hete luchtstraal en naar buiten stromende massa niet op personen of dieren richten.



Sluit het apparaat **alleen aan een geaard stopcontact** aan. Elke onderbreking van de aardleiding binnen of buiten het apparaat is gevaarlijk!

Alleen verlengsnoeren met aardleiding gebruiken!



Veiligheid



De nominale spanning die op het apparaat staat aangegeven moet overeenkomen met de netspanning. Bij netuitval moeten hoofdschakelaar en aandrijving worden uitgeschakeld (arrêtering ontgrendelen).



Een aardlekschakelaar is bij het gebruik van het apparaat op bouwplaatsen ter beveiliging van personen **dringend noodzakelijk**.



Gevaar voor verblinding! Vermijd direct oogcontact met de LED-lichtstraal. Het apparaat **moet onder toezicht** in werking zijn. De warmte kan brandbare materialen bereiken die zich buiten zichtwijdte bevinden.

Het apparaat mag alleen door **daarvoor opgeleide technici** of onder toezicht van zulke personen worden gebruikt. Het is voor kinderen verboden dit apparaat te gebruiken.



Bescherm het apparaat tegen vocht en damp.

Conformiteit

Leister Technologies AG, Galileo-Strasse 10, CH-6056 Kaegiswil/SZwitzerland bevestigt dat dit product in de door ons in omloop gebrachte uitvoering aan de eisen van de volgende EU-richtlijnen voldoet.

Richtlijnen: 2006/42,
2004/108 (tot 19.04.2016), 2014/30 (vanaf 20.04.2016),
2006/95 (tot 19.04.2016), 2014/35 (vanaf 20.04.2016),
2011/65

Geharmoniseerde normen: EN 12100, EN 55014-1, EN 55014-2, EN 61000-6-2, EN 61000-3-2,
EN 61000-3-3, EN 62233, EN 60335-1, EN 60335-2-45, EN 50581

Kaegiswil, 04.02.2016

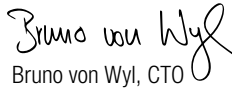
Bruno von Wyl, CTO

Andreas Kathriner, GM

Afvalverwijdering



Bied elektrisch werkende gereedschappen, toebehoren en verpakkingen aan voor milieuvriendelijk hergebruik. **Uitsluitend EU-landen:** Voer het lasapparaat niet af via de inzameling van huishoudelijk afval!

Technische gegevens

Spanning	V~	100	120	230
Vermogen	W	1500	1800	1600
Frequentie	Hz	50/60	50/60	50/60
Luchttemperatuur	°C	max. 360		
Plastificeertemperatuur	°C	max. 260		
Opbrengst (Ø 3 mm)	kg/h	HD-PE 0.2–0.5; PP 0.2–0.5		
Opbrengst (Ø 4 mm)	kg/h	HD-PE 0.3–0.8; PP 0.3–0.75		
Lasdraad	mm	Ø 3 / Ø 4		
Emissieniveau	L _{pA} (dB)	76 (K = 3 dB)		
Maten L × b × h	mm	435 × 264 × 91 (zonder lasschoen)		
Gewicht	kg	4.7 (zonder netsnoer)		
Conformiteitstekens		CE	CE	CE
Veiligheidskenmerk				Ⓢ
Beschermingsklasse I		Ⓛ	Ⓛ	Ⓛ

Technische wijzigingen voorbehouden

Beschrijving van het apparaat

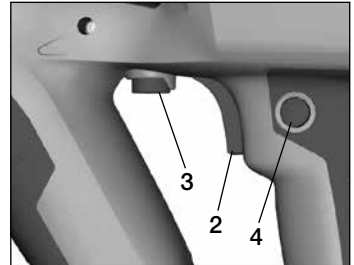
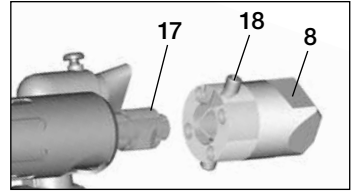
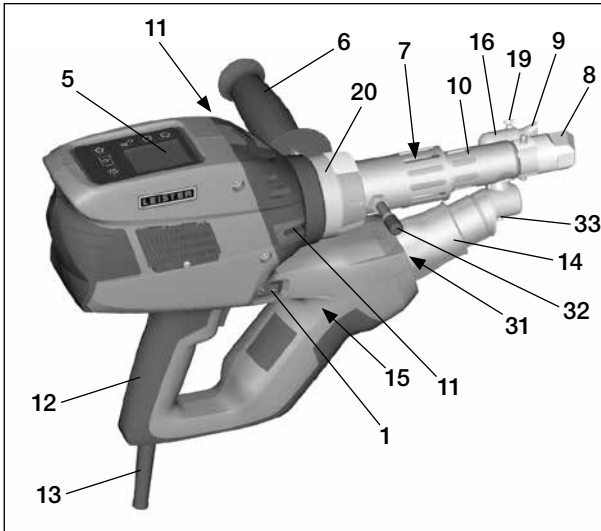

- | | |
|------------------------------------------|-------------------------------------------------|
| 1 Hoofdschakelaar | 13 Netaansluitkabel |
| 2 Aan/Uit-schakelaar voor de aandrijving | 14 Verwarmingselement - Beschermpijp |
| 3 Potentiometer | 15 Blazer (borstelloos) |
| 4 Arrêtering van de aandrijving | 16 Heteluchtgeleider |
| 5 Scherm | 17 Extrudeermondstuk |
| 6 Handgreep | 18 Klenschroef voor de lasschoen |
| 7 Mantelverwarming | 19 Klenschroef voor het voorverwarmend mondstuk |
| 8 Lasschoen | 20 Klemzadel |
| 9 Voorverwarmend mondstuk | 31 LED-verlichting |
| 10 Beschermpijp | 32 Steunbout |
| 11 Invoeropening voor de lasdraad | 33 Klenschroef voor de heteluchtgeleider |
| 12 Apparaatgreep | |

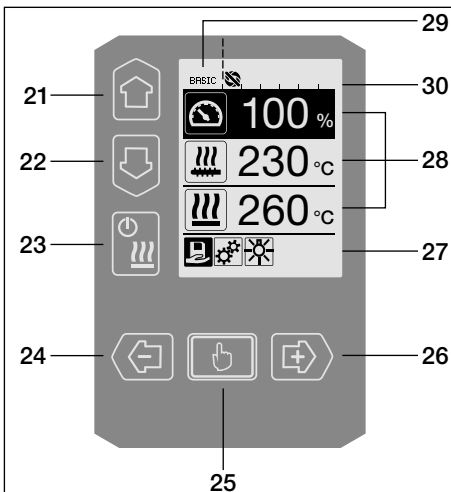





Bediening

- 21 Toets «Omhoog»
- 22 Toets «Omlaag»
- 23 Toets verwarming «Aan / Uit»
- 24 Toets «Minus»
- 25 Toets «Bevestigen»
- 26 Toets «Plus»





Uitleesscherm

- 27 Presentatie van mogelijke functies
- 28 Presentatie van het arbeidsproces
- 29 Statusuitlezing «Zone 1»
- 30 Statusuitlezing «Zone 2»

Beschrijving van de bediening

Toetsenbordmodus		Actuele selectie uit de presentatie van het arbeidsproces	Actuele selectie uit de presentatie van de mogelijke functies
	Omhoog (21) Omlaag (22)	Wijzigen van de positie binnen de uitlezing van het arbeidsproces	Wisseling van presentatie van de mogelijke functies naar presentatie van het arbeidsproces
	Verwarming Aan / Uit (23)	Geen functie	Wisselen van lasmodus naar afkoelmodus Wisselen van afkoelproces naar lasmodus Wisselen van aanloopmodus naar lasmodus
	Minus (24) Plus (26) (kortstondig indrukken)	Instellen van de gewenste streefwaarde per 5 °C - respectievelijk in stappen van 5%.	Wijzigen van positie binnen de presentatie van de mogelijke functies
	Minus (24) Plus (26) (indrukken en ingedrukt houden)	Instellen van de gewenste streefwaarde per 10°C - respectievelijk in stappen van 10%.	Wijzigen van positie binnen de presentatie van de mogelijke functies
	Bevestigen (25)	De ingestelde waarde wordt direct geaccepteerd en de selectie springt direct terug naar de presentatie van de mogelijke functies.	De geselecteerde functie wordt uitgevoerd.

Beschrijving van het uitleesscherf

Statusuitlezing «Zone 1» (29)	
PE-HD	Actueel geselecteerde profiel. Bij profielnamen van meer dan zes karakters worden aanvankelijk de eerste zes karakters getoond. Daarna verschijnen de overige lettertekens.
1m16s	Resterende duurtijd totdat de aandrijving wordt vrijgegeven (1 min en 16 s)
Statusuitlezing «Zone 2» (30)	
	Aandrijving vrijgegeven
	Aandrijving niet vrijgegeven
	Waarschuwing aanwezig (koolborstels / aandrijving)
	Toetsblokkering (verschijnt uitsluitend bij actieve toetsblokkering)
	Lucht- en plasticerverwarming is ingeschakeld

Presentatie van functies en werking

- Het in de presentatie van functies of arbeidsproces gemarkeerde, gepresenteerde veld of symbool representeert altijd de actuele selectie.
- De presentatie van het arbeidsproces toont altijd actuele waarden, tenzij een positie is geselecteerd. In dat laatste geval wordt de streefwaarde getoond.
- Hebt u «Show Set Values» [Toon ingestelde waarden] geactiveerd? Dan verschijnen de actuele waarde en de streefwaarde (klein).

Functiepresentatie (27)	
	Selecteer vrije en op voorhand gedefinieerde profielen.
	Instellingen
	Terug naar de arbeidsuitleiding (direct verlaten van een menu)
	Aan- of uitschakelen van de LED. Deze functie is uitsluitend beschikbaar mits de LED werd geactiveerd.
	Een niveau terug
	Terugstellen van instellingen of bedrijfsurenteller
	Onderhoudsmenu (uitsluitend oproepbaar na het invoeren van een wachtwoord)
	Opslaan
	Geselecteerde positie wissen
	Geselecteerde positie bewerken
	Inleiden van het afkoelproces

Uitlezing van het arbeidsproces (28)	
	Streefwaarde Capaciteit van de aandrijving [%]
	Streefwaarde Plasticeertemperatuur [°C / °F]
	Streefwaarde Luchttemperatuur [°C / °F]
	Streefwaarde Luchtopbrengst [%]
	Informatievenster
	De pijl-omhoog en de voortgangsbalk laten zien, dat de streefwaarde (merkteken op de voortgangsbalk) nog niet is bereikt (te koud). De knipperende waarde stelt de actuele waarde voor. De waarde naast de voortgangsbalk is de ingestelde streefwaarde.
	De pijl-omlaag en de voortgangsbalk laten zien, dat de streefwaarde (merkteken op de voortgangsbalk) nog niet is bereikt (te heet). De knipperende waarde stelt de actuele waarde voor. De waarde naast de voortgangsbalk is de ingestelde streefwaarde.
	Hebt u « Show Set Values » [Toon ingestelde waarden] geactiveerd? Dan worden de actuele temperatuur (groot) en de streef temperatuur (klein) getoond.
	Afkoelmodus
	Apparaat in waakmodus Het apparaat zal na het aflopen van de teller van de « Cool down modus » [afkoelmodus] starten
	Het apparaat meldt een storing. Bovendien verschijnt een storingmeldcode (apparaat niet meer gereed voor gebruik). Neem contact op met een daartoe geautoriseerd onderhoudsbedrijf.
	Lucht-verwarmingselement defect
	Temperatuur van het apparaat te hoog. Laat het apparaat afkoelen.

Overzicht over de arbeidspresentatie

Uitlezing van het opstartproces

Uitlezing tijdens het opstarten, inclusief versienummer van de programmatuur van de vermogensmodule



Cool down mode [Afkoelmodus] (Afkoelen)

In deze modus zijn de verwarmingen uitgeschakeld en verkeert het apparaat in de afkoelmodus. Is bij het inschakelen van het apparaat de temperatuur van de voorverwarmende lucht hoger dan 100 °C? Dan gaat het apparaat automatisch over naar de «Cool down mode» [afkoelmodus]. Dit proces wordt afgesloten zodra de temperatuur van de voorverwarmende lucht gedurende twee minuten minder dan 100 °C bedraagt.

Wilt u de verwarmingen weer inschakelen?

Druk dan op **toets (23)** «**Heizung Ein/Aus**» [«**Verwarming Aan/Uit**»] of op **toets (25)** «**Bestätigen**» [«**Bevestigen**»].

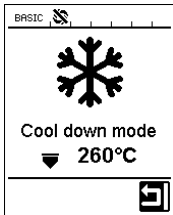

Maintenance servicing [Onderhoudsbeurt]

Blijkt na het opstarten dat de onderhoudsinterval voor de aandrijfmotor is verstreken, dan verschijnt de melding «Maintenance Servicing» [«Onderhoudsbeurt»].

Na een druk op de **toets (25)** «**Bestätigen**» [«**Bevestigen**»] kunt u verder werken. Breng het apparaat beslist naar uw onderhoudswerkplaats.



Uitlezingen na het starten

Na het starten worden alle streefwaarden uitgelezen. Hoewel de verwarming nog niet is ingeschakeld, kunnen al wel alle streefwaarden worden ingesteld.

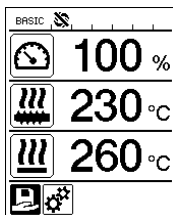

Uitlezingen na het opstarten van het lasproces

Uitlezingen tijdens het opwarmen

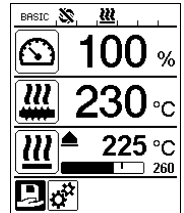

Select Profile [Profielkeuze]

Selecteer een door u gedefinieerd profiel of een door Leister op voorhand ingevoerd profiel. Hoofdstuk «Select Profile» [«Profielkeuze»] beschrijft gedetailleerd op bladzijde 108 de manier van het selecteren van een profiel.

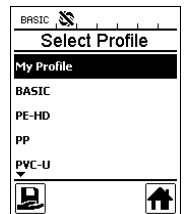

Setup [Configureren]

Via de basisinstelling komt u via het menu «Setup» [«Configureren»] in de omgeving waar de profielen zijn opgeslagen en in de functie 'Waakstand'. Na selectie van «Advanced Mode» [«Geavanceerde modus»] worden nog meer instelmogelijkheden geboden.

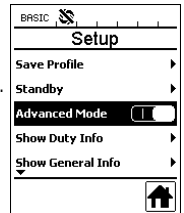
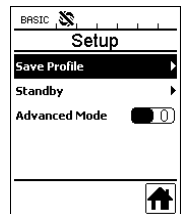

Save profile [Profiel opslaan]

Hoofdstuk «Profile definiëren» [«Profiel definiëren»] beschrijft gedetailleerd op bladzijden 110 en 111 hoe u vrijelijk profielen kunt opslaan.

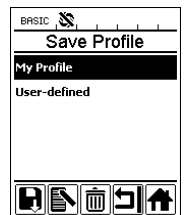

Overzicht over de arbeidspresentatie

Standby [Wakstand]

Het apparaat gaat automatisch over op het uitlezen van de wakstand mits de wakstandmodus is geactiveerd en mits u gedurende de tijd, die is gedefinieerd onder «**Standby Interval**» [«**Wakstand-interval**»], geen enkele toets op de bediening indrukt noch de **Aan/Uit-schakelaar van de aandrijving (2)** bedient. Het apparaat schakelt automatisch over naar de afkoelmodus tenzij u binnen de daarop volgende 180 s de **toets (25)** [«**Bevestigen**»] indrukt.

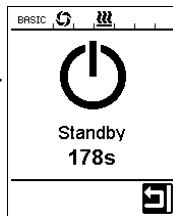
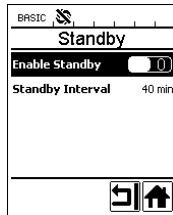

Duty Info [bedrijfsinformatie]

Hours Drive: actuele aantal bedrijfsuren van de aandrijving (terugstelbaar).
Hours Blower: actuele aantal bedrijfsuren van de blazer.
Hours Machine: actuele aantal bedrijfsuren van de machine.

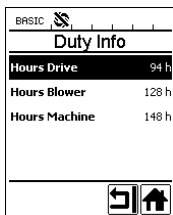

General Info [algemene informatie]

Firmware HMI: [harde programmatuur van de mens/machine-interface] Versie van het in de apparatuur ingebouwde programma voor de uitleesmodule (communicatiemodule).
Firmware Machine: [harde programmatuur van de machine] Versie van het in de apparatuur ingebouwde programma van de vermogensmodule
Production Info: [Fabricage-informatie] Gegevens over het moment van fabricage.

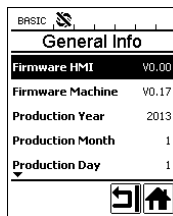

Waarschuwingen

Werd er een waarschuwing afgegeven? Dan meldt de statusuitlezing dat door het symbool  te tonen. In het menu «Warnings» [«Waarschuwingen»] treft u meer informatie aan over de actuele waarschuwing.

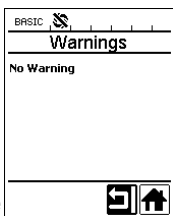

Machine Setup [Configuratie van de machine]

Het hoofdstuk «Machinesinstellingen» [«Configuratie van de machine»] beschrijft gedetailleerd alle instellingen van de machine

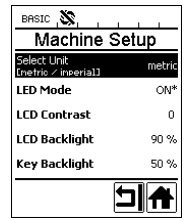

Application Mode [Applicatiemodus]

Is de «Application Mode» [«Applicatiemodus»] geactiveerd? Dan toont de uitlezing van de bedrijfsmodus gedetailleerd informatie over de actuele plasticteertemperatuur en de belasting van de heteluchtblazer en de plasticteerverwarming.

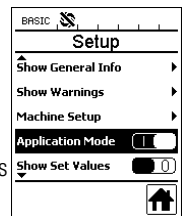

Plast : [plastische massa] 80% 222 °C
Heat : [verwarming] 40% 197 °C
Amb.: [omgeving] : bij 25 °C
Mains :[frequentie van de voeding] 50 Hz

Hebt u «Show Set Values» [toon ingestelde waarden] geactiveerd? Dan worden de actuele temperatuur (groot) en de streef temperatuur (klein) getoond.

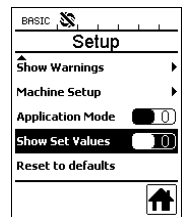

Terugstellen naar de verstekwaarden

Hebt u het menu «Reset to defaults» [«Terugstellen naar verstekwaarden»] geselecteerd en de keuze van een functie  bevestigd? Dan worden alle klantspecifieke profielen gewist. Instellingen, die via het configureermenu werden gewijzigd, worden weer teruggesteld naar de fabrieksinstelling.

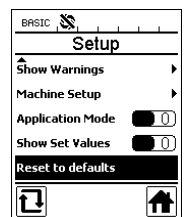

Menunavigatie

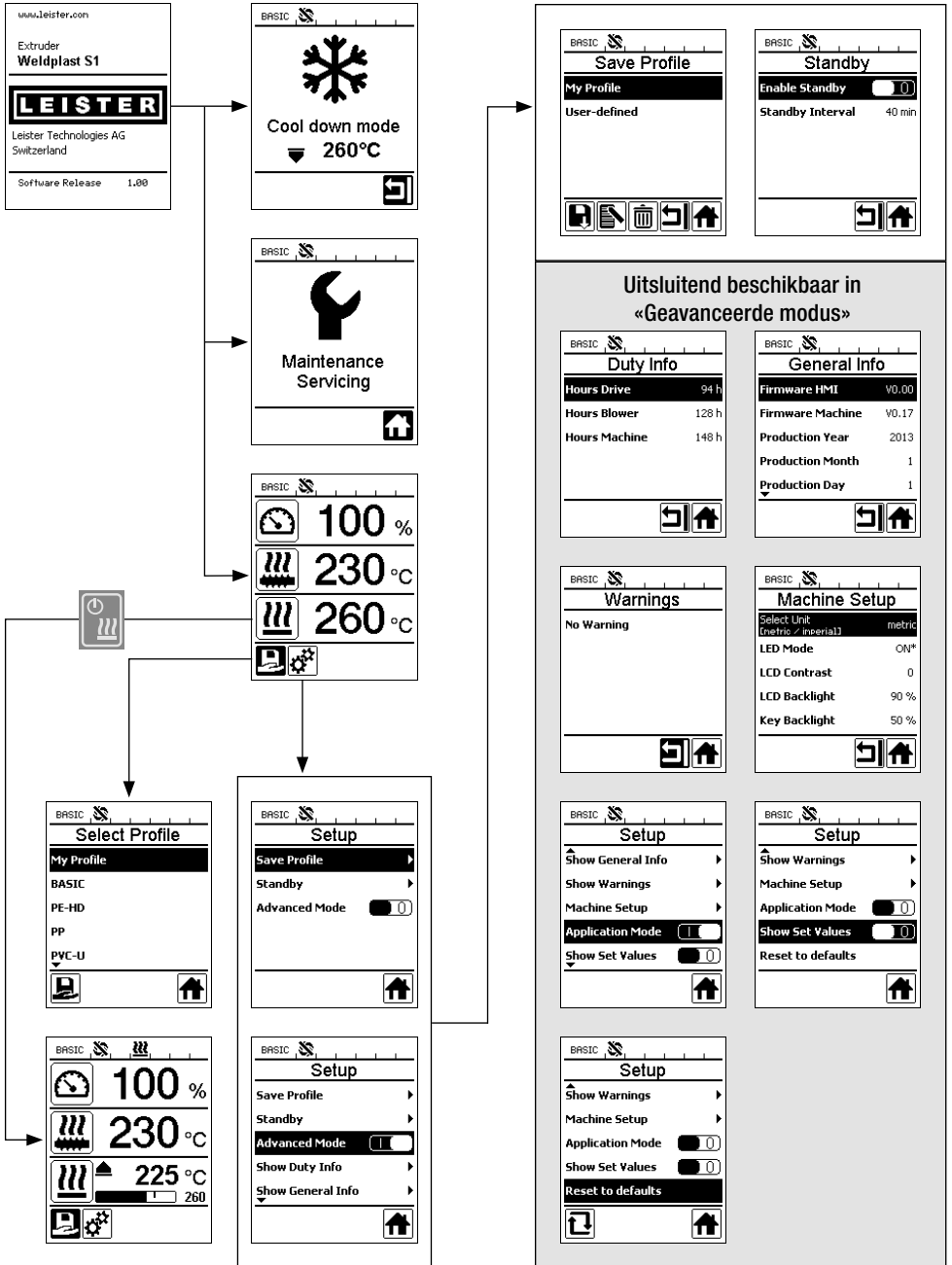



Controleer vóór de ingebruikname het aansluitsnoer (13), stekker en verlengsnoer op elektrische en mechanische schade.

De hand-lasextruders mag niet in een ontvlambare omgeving of bij ontploffingsgevaar worden gebruikt. Let bij het werk op een stabiele lichaamshouding. Netkabel en lasdraad moeten goed beweegbaar zijn en mogen de gebruiker of derden niet bij het werk hinderen.

Hand-lasextruders op een vuurvaste onderlegger plaatsen! Hete metalen delen en de hete luchtstraal moeten voldoende afstand tot onderlegger en wanden houden.

Werkruimte



Voor het inbedrijfstellen en het weggelgen van de hand-lasextruder biedt Leister een **apparaatsteun**.

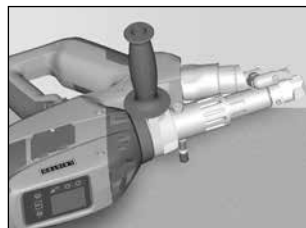

Bij onderbreking van de laswerkzaamheden moet de aandrijving worden uitgeschakeld met de **IN-/UIT-schakelaar aandrijving (2)**.

Zet de hand-lasextruder met correct ingestelde en stevig aangetrokken **handgreep (6)** conform afbeelding op een stevige vuurvaste ondergrond of **stelbout (32)**.

Handgreep

Instellen van de handgreep

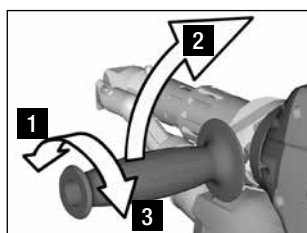

- 1 Door de **handgreep (6)** tegen de richting van de klok in te draaien maakt u de klem los.
- 2 **Breng de handgreep (6)** in de gewenste stand.
- 3 Door de **handgreep (6)** in de richting van de klok te draaien zet u de klem weer vast.

Demonteren / monteren van de handgreep

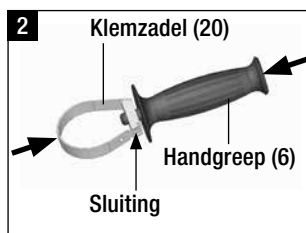
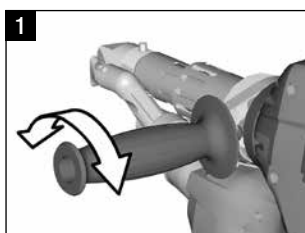

Gevaar voor verbranding! Laat het apparaat afkoelen.

Demonteren van de handgreep

- 1 Maak de klem los door de **handgreep (6)** tegen de richting van de klok in te draaien.
- 2 Druk op de **handgreep (6)** en op het **klemzadel (20)** om de **sluiting te openen** (zie de pijl). **Neem de handgreep (6) inclusief klemzadel (20) weg.**

Monteer de handgreep in omgekeerde volgorde van de hierboven genoemde handelingen.

Verlengkabels

- Bij gebruik van verlengkabels op de minimale doorsnede letten:
- Verlengkabel moet voor de plaats van gebruik (b.v. in de open lucht) toegelaten zijn en een dienovereenkomstig kenmerk dragen.
- Bij gebruik van een noodstroomaggregaat als energiebron geldt hier-voor als nom. vermogen: 2 × nom. vermogen van de Hand-lasextruders

Lengte [m]	Minimale doorsnede (bij 100 – 230V~) [mm ²]
tot 19	2.5
20 – 50	4.0

Starten van het apparaat

- Monteer de corresponderende **lasschoen (8)**, het bijbehorende **voorverwarmende mondstuk (9)** evenals de **heteluchtgeleider (16)** (zie blz. 113 voor het wisselen van toebehoren).



Sluit het apparaat aan op de netspanning. De netspanning, die op het apparaat vermeld staat, moet overeenstemmen met de feitelijke netspanning.

- Schakel de extruder in door de **hoofdschakelaar (1)** in de stand 'Aan' te brengen. Afhankelijk van de temperatuur van de voorverwarmende lucht verschijnt op het **scherm (5)** de opstartuitleiding of «Cool down mode» [«Afkoeelmodus»]. Druk op **toets (23) «Heizung Ein / Aus»** [«Verwarming Aan/Uit»]  om het opwarmproces te starten.
- Zodra het apparaat gereed voor gebruik is, zal de **LED-verlichting (31)** automatisch inschakelen (fabrieksinstelling).
- Via de **Aan/Uit-schakelaar voor de aandrijving (2)** kunt u nu de aandrijving laten aanlopen.

Lasproces

- Voer een lasdraad (ø 3 of 4 mm) in via de **invoeropening (11) voor de lasdraad**.
- De **lasdraadinvoer (11)** trekt automatisch de lasdraad naar binnen. Het toevoeren van lasdraad mag geen weerstand ondervinden.



LET OP!

Gebruik het apparaat altijd met lasdraad, maar steek nimmer tegelijkertijd in beide lasdraad-invoeropeningen een lasdraad.

- Stel met behulp van de **potentiometer (3)** de intreksnelheid van de lasdraad in.
- Onderbreek de toevoer van plastische massa via de **aan/uit-schakelaar voor de aandrijving (3)**.
- Richt het **voorverwarmende mondstuk (9)** op de laszone.
- Verwarm met pendelende bewegingen de laszone voor.
- Plaats het apparaat op de voorbereide laszone en bedien opnieuw de **aan/uit-schakelaar voor de aandrijving (2)**.
- Maak een proeflas conform de - door de fabrikant van het materiaal verstrekte - lashandleiding en conform de nationale normen of richtlijnen. Inspecteer de proeflas.
- Pas zo nodig de temperatuurinstelling, hoeveelheid plastische massa en hoeveelheid lucht aan (zie hoofdstuk "Instellen van lasparameters" op blz. 107).
- Bij een langduriger lasproces kunt u de **aan/uit-schakelaar voor de aandrijving (2)** door middel van de **arrêtering van de aandrijving (4)** op continu bedrijf houden.

LET OP!

- PVC-U en PVC-C worden in het menu van de PVC-U verwerkt.
- Wij adviseren u om na het afsluiten van de laswerkzaamheden de Hand-lasextruders te spoelen met HD-PE om corrosieschade bij het verwerken van PVC-U, PVC-C, ECTFE, PVDF en dergelijke te voorkomen.





Uitschakelen van het apparaat

- Los de **arrêtering van de aandrijving (4)** en laat de **Aan/Uit-schakelaar van de aandrijving (2)** los.
- Neem het lasmateriaal uit de **lasschoen (8)** weg.
- Druk op **toets (23) «Heizung Ein / Aus» [«Verwarming Aan/Uit»]**  en bevestig door **toets (25) «Bestätigen» [«Bevestigen»]** in te drukken om de verwarming uit te schakelen. Het apparaat gaat over naar de afkoelmodus «Cool down mode».
- Na het afkoelproces zal de blazer automatisch uitschakelen. Op het **scherm (5)** verschijnt de startuitleiding.
- **Breng de hoofdschakelaar (1)** in de stand 'Uit'.



Scheid de netspanningkabel van het elektriciteitsnet.

Instellen van een parameter

- Wilt u een op voorhand ingestelde streefwaarde wijzigen (bijvoorbeeld een streef-plasticeertemperatuur)? Druk dan op de **toetsen 21/22 «Auf» [«Omhoog»]**  of **«Ab» [«Omlaag»]**  om de gewenste streefwaarde in te stellen. Zolang de streefwaarde gemarkeerd wordt getoond, kunt u deze via een druk op de **toetsen 24/26 «Plus»**  of **«Minus»**  wijzigen. Bij de WELDPLAST S1 kunt u vier streefwaarden instellen:



Capaciteit (max. plasticeercapaciteit als de potentiometer in stand '5' staat of op 100% is ingesteld).



Plasticeertemperatuur





Luchttemperatuur

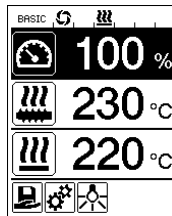

Luchtvolume

- De uitlezing van het arbeid-proces kan maximaal drie elementen tonen.



- U kunt andere elementen oproepen door de **toetsen 21/22 «Auf» [«Omhoog»]**  of **«Ab» [«Omlaag»]**  in te drukken.

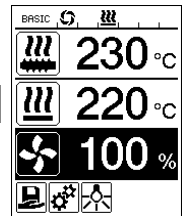



- U kunt de hoeveelheid geproduceerde plastische massa tijdens het extruderen direct aanpassen en wel door de **potentiometer (3)** in stappen van 5% te verstellen. Het bereik loopt daarbij van minimaal 35% tot de maximaal ingestelde hoeveelheid te produceren plastische massa. De actueel ingestelde waarde is daarbij altijd zichtbaar in de uitlezing van het arbeidsproces. Beschouw de in de uitlezing van het arbeidsproces ingestelde waarde als de maximale waarde. U kunt met behulp van de **potentiometer (3)** uitsluitend instellen tot de ingestelde instelwaarde. Deze waarde staat typisch echter op 100% ingesteld.
- Is echter de productie van plastische massa met de minimale opbrengst (35%) te groot, dan moet u wisselen naar gebruik van een lasdraaddikte van 3 mm.
- Is echter de productie van plastische massa met de minimale opbrengst (100%) te klein, dan moet u wisselen naar gebruik van een lasdraaddikte van 4 mm.

Select Profile [Profielkeuze]

- Selecteren van een op voorhand gedefinieerd profiel of van een vrij profiel
- De WELDPLAST S1 beschikt over zes op voorhand door Leister gedefinieerde profielen en maximaal tien vrij definieerbare profielen:

Lasprofielen		Max. opbrengst [%]	Streefwaarde voor de plasticiteit-temperatuur [°C / °F]	Streefwaarde voor de luchttemperatuur [°C / °F]	Luchtvolume [%]
1	BASIC	instelbaar	instelbaar	instelbaar	instelbaar
2	PE-HD	100	230	260	100
3	PP	100	240	260	100
4	PVC-U	100	200	300	100
5	PVDF	100	250	320	100
6 ... 16	Vrije profielen	instelbaar	instelbaar	instelbaar	instelbaar

- Door het symbool  in de **functieuitzeizing (27)** te selecteren roept u het menu «Select Profile» [«Selecteer profiel»] op. Een van deze zes op voorhand gedefinieerde (1 ... 6) of een klantspecifiek vrij profiel (7 ... 16) kunt u via de **toetsen 21/ 22 «Auf» [«Omhoog»]**  of **«Ab» [«Omlaag»]**  selecteren.
- Wijzigt u de streefwaarden (profielen 2 ... 16) tijdens het bedrijf? Dan worden die waarden niet in het profiel opgeslagen!
- De in het profiel gedefinieerde waarden verschijnen steeds weer nadat u de machine hebt uitgeschakeld en weer hebt ingeschakeld.
- Selecteer profiel BASIC (1) als u de laatst ingestelde waarden wilt gebruik na het herinschakelen van de machine.
- Het actueel geselecteerde profiel verschijnt links in de **statusuitzeizing «Bereik 1» (29)**.

PE-HD 

Bewaking van de lasparameters

- De actuele plasticiteittemperatuur en de luchttemperatuur worden doorlopend bewaakt. Wijkt de actuele waarde af van de bijbehorende streefwaarde? Dan wordt dat in de **uitzeizing van het arbeidsproces (28)** getoond («Show Set Values» [«Toon ingestelde waarden»] niet geactiveerd).

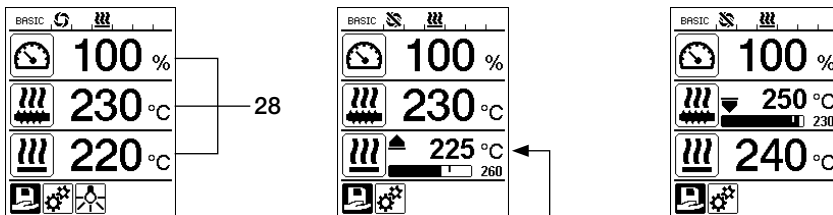

- De actuele waarde komt overeen met de streefwaarde.
- De actuele plasticiteittemperatuur is te laag. Een knipperend signaal indiceert het opwarmproces (pijl omhoog en voortgangsbalk).
- De actuele waarde van de plasticiteittemperatuur is te hoog. Een knipperend signaal indiceert het afkoelproces (pijl omlaag en voortgangsbalk).

Vrijgeven van de aandrijving

- Voor het vrijgeven van de aandrijving zijn er vier verschillende relaxatieduurtijden (zie de tabel). Deze hangen af van de actuele plasticiteittemperatuur evenals van de ingestelde streef-plasticiteittemperatuur. De voorverwarm-lucht heeft geen invloed op het vrijgeven van de aandrijving.
- De vrijgeefzone begint zodra de actuele plasticiteittemperatuur hoger is dan den streef-temperatuur -20 K.
- **Bijbehorende symbool in de statusuitlezing:**



Aandrijving is niet vrijgegeven



Aandrijving is vrijgegeven

Actuele plasticiteittemperatuur bij het inschakelen van de verwarming of bij het verstellen van de streef-plasticiteittemperatuur	Streef-plasticiteittemperatuur	Vrijgeefduur na het bereiken van de vrijgeefzone
Streef-plasticiteittemperatuur - 5 K < Actuele plasticiteittemperatuur	—	De aandrijving wordt direct vrijgegeven
Streef-plasticiteittemperatuur - 20K < Actuele plasticiteittemperatuur < Streef-plasticiteittemperatuur - 5 K	—	30 s
Streef-plasticiteittemperatuur - 20K > Actuele plasticiteittemperatuur (onder de vrijgeefzone)	>190 °C	2 min 30 s
Streef-plasticiteittemperatuur - 20K > Actuele plasticiteittemperatuur (onder de vrijgeefzone)	<195 °C	3 min 30 s

- De aandrijving wordt weer geblokkeerd als de WELDPLAST S1 de actuele plasticiteittemperatuur bij vrijgegeven aandrijving niet langer dan 10 s in de vrijgeefzone kan aanhouden. Heeft het apparaat de vrijgeefzone weer bereikt? Dan wordt de aandrijving na het verstrijken van een in de tabel vermelde relaxatieduur weer vrijgegeven

Toetsblokkering



- U activeert of deactiveert de toetsblokkering door tegelijkertijd en gedurende minstens twee seconden de **toetsen 21 / 22 «Auf»**  **en «Ab»**  **in te drukken.**

Onderbreking van de netspanning

Status van de aandrijving voorafgaan aan de netspanningonderbreking	Duur van de netspanningonderbreking	Status van de WELDPLAST S1 na onderbreking van de netspanning
Aandrijving vrijgegeven uitlezing van het arbeidsproces 'Lassen'	≤5 s	Het apparaat start zonder heraanloopbeveiliging en gaat direct over naar de toestand, die voor de netspanningonderbreking bestond.
Aandrijving vrijgegeven (voorverwarmende lucht >100 °C)	>5 s	Het apparaat gaat direct over naar de «Cool down modus» [«Afkoelmodus»]
Aandrijving vrijgegeven (voorverwarmende lucht <100 °C)	>5 s	Het apparaat start en op het scherm (5) verschijnt de startuitlezing.

Invoeren van namen of wachtwoorden

- Via de toetsenbordmodus kunt u namen definiëren of wachtwoorden invoeren met een lengte van maximaal 12 karakters.

Toetsenbordmodus	Selectie van karakters 34	Selectie van symbolen 35
	Omhoog (21) Omlaag (22)	Verticale karakterselectie
	Minus (24) Plus (26)	Horizontale karakterselectie
	Bevestigen (25)	Bevestig het geselecteerde karakter. Bevestig het geselecteerde symbool



	Wisselen tussen hoofdletters en kleine letters
	Verplaatsen van de cursor binnen de naam
	Invoeren van een spatie
	Wissen van een enkel karakter (karakter links van de cursor)
	Door selectie van dit symbool roept u de functieuitleiding op 27

Profiel definiëren

- Via het menu «Save Profile» [«Profiel opslaan»] kunt u streefwaarde-instellingen van de maximale opbrengst aan plastische massa, de plasticdeer-luchttemperatuur en het luchtdebiet opslaan onder een door u gekozen naam (zie de paragraaf «Eingabe von Namen oder Passwörtern» [«Invoeren van namen of wachtwoorden»]).
- Aanmaken van een nieuw profiel:**
 - Stel via de **uitleiding van het arbeidsproces (28)** de gewenste streefwaarde in met behulp van de **toetsen 24 / 26 «Plus»**  of **«Minus»** .
 - Roep via de **functieuitleiding (27)** met behulp van **toets 26 «Plus»**  het menu 'Instellingen'  op.
 - Kies in het menu «Setup» [«Configureren»] met behulp van **toets 26 «Plus»**  de functie «Save Profile» [«Profiel opslaan»].
 - Selecteer het profiel «User-defined» [«Door gebruiker gedefinieerd»] en bevestig de selectie door op **toets (25)**  te drukken.
 - Selecteer in de **functieuitleiding (27)** het symbool  «Ausgewählte Position bearbeiten» «Geselecteerde positie bewerken» en bevestig de selectie door op **toets (25)**  te drukken.
 - Voer de gewenste profielnaam (zie de paragraaf "Invoeren van namen of wachtwoorden") in, selecteer via **toets 26 «Plus»**  het symbool  en bevestig de invoer door op **toets (25)**  te drukken.
 - Bevestig in de **functieuitleiding (27)** het geselecteerde symbool «Speichern» («Opslaan»)  door op **toets (25)**  te drukken. Het profiel werd met succes opgeslagen en geselecteerd.

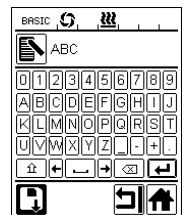
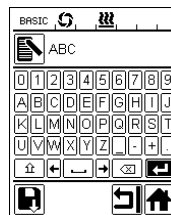
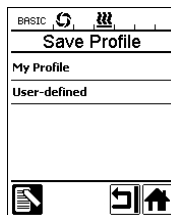
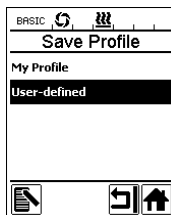
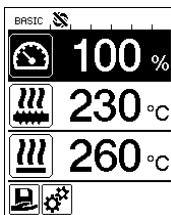

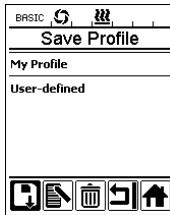
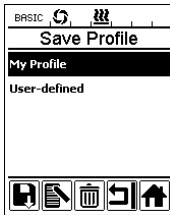
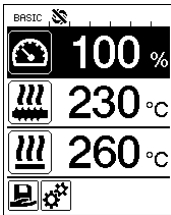

Profiel definiëren

- **Wijzigen van een bestaand profiel (uitgezonderd de door Leister ingevoerde profielen):**
 - Stel via de **uitlezing van het arbeidsproces (28)** de gewenste streefwaarde in met behulp van de **toetsen 24 / 26 «Plus»**  of **«Minus»** .
 - Roep via de **functieuitlezing (27)** met behulp van **toets 26 «Plus»**  het menu 'Instellingen'  op.
 - Kies in het menu «Setup» [«Configureren»] met behulp van **toets 26 «Plus»**  de functie «Save Profile» [«Profiel opslaan»].
 - Selecteer het te wijzigen profiel en bevestig de selectie door op **toets (25)**  te drukken.
 - Selecteer in de **functieuitlezing (27)** het symbool  «Ausgewählte Position bearbeiten» [«Geselecteerde positie bewerken»] en bevestig de selectie door op **toets (25)**  te drukken.
 - Voer de gewenste profielnaam (zie de paragraaf "Invoeren van namen of wachtwoorden") in, selecteer via **toets 26 «Plus»**  het symbool  en bevestig de invoer door op **toets (25)**  te drukken.
 - Bevestig in **functieuitlezing (27)** het geselecteerde symbool «Speichern» («Opslaan»)  door op **toets (25)**  te drukken. Het profiel werd met succes opgeslagen en geselecteerd.



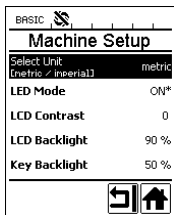



Instellingen van de machine



Menu	Functie
Select Unit [Selecteer module]	Instellen van de toegepaste module – metrisch / imperial
LED-modus	<p>LED-modus:</p> <ul style="list-style-type: none"> – ON*: U kunt de LED-verlichting uitsluitend inschakelen als de aandrijving is vrijgegeven. Zodra de aandrijving is vrijgegeven verschijnt in de functieuitlezing (27) het LED-symbool . Via dit symbool kunt u naar believen de LED-verlichting inschakelen of uitschakelen. De LED-modus wijzigt daarbij niet. – ON: De LED-verlichting is permanent ingeschakeld. In de functieuitlezing (27) verschijnt het LED-symbool . Via dit symbool kunt u naar believen de LED inschakelen of uitschakelen. De LED-modus wijzigt daarbij niet. – OFF: De LED-verlichting is permanent uitgeschakeld.
LCD-contrast	Instellen van het contrast van het LC-scherm
LCD-achterverlichting	Instellen van de achterverlichting van het LC-scherm
Achterverlichting voor het toetsenbord	Instellen van de achterverlichting voor het toetsenbord

Waarschuwingen en storingmeldingen

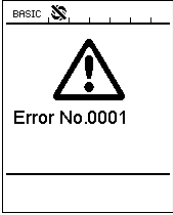
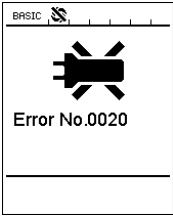
- De gebruiker kan zonder enige beperking verder werken als er sprake is van een waarschuwing. Meer gedetailleerde informatie betreffende de waarschuwing kunt u oproepen via de **functieuitleasing (27)** en menu 'Instellingen'  onder «Show Warnings» [«Toon Waarschuwingen»].
- Als daarentegen sprake is van een storingmelding, dan zal het apparaat alle verwarmingen uitschakelen en zal de aandrijving niet meer worden vrijgegeven.

Soort melding	Uitlezing	Storing- meld- code	Omschrijving van de storing
Waarschuwing		—	<p>Waarschuwend symbool  in de statusuitleasing (30). Vervang de koolborstels in de aandrijving. Nadat dit waarschuwend symbool voor de eerste keer is verschenen, kunt u de aandrijving nog ongeveer gedurende 5 h gebruiken. Vervolgens verschijnt de storingmelding «Error No.0400» en wordt de aandrijving niet meer vrijgegeven.</p>
Storing		0001	Te hoge temperatuur van het apparaat Laat het apparaat afkoelen.
		0020	Luchtverwarmend element defect
Storing ! Neem contact op met het Leister Service Center		0004	Apparatuurstoring.
		0008	Thermoelement voor de luchttemperatuur defect.
		0010	Thermoelement voor de temperatuur van de plastische massa defect.
		0040	Verwarmingselement voor de plastische massa defect.
		0100	Blazer defect.
		0200	Storing in de communicatie.
		0400	Probleem met koolborstels of te hoge temperatuur van de aandrijving

Wisselen van toebehoren of accessoires



Gevaar voor verbranding!



Werk uitsluitend als u temperatuurbestendige handschoenen draagt.

Vervangen van een lasschoen

• Demonteren

- Schakel het bedrijfswarme apparaat uit en scheid het apparaat van het elektriciteitsnet.
- Neem de **lasschoen (8)** weg door de **klenschroeven (18)** van het **extrudeermondstuk (17)** te lossen.
- Verwijder resten lasmateriaal van het **extrudeermondstuk (17)** en wel telkens als u van lasschoen wisselt. Borg dat het mondstuk stevig is vastgeschroefd.

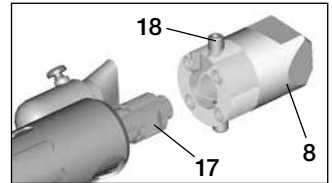

• Monteren

- Schuif een op de lasnaad aangepaste **lasschoen (8)** op het **extrudeermondstuk (17)** en zet die vast door de **klenschroeven (18)** aan te draaien.

Wisselen van heteluchtgeleider

• Demonteren

- Los de **klenschroef (33)**. U kunt de **heteluchtgeleider (16)** afnemen of in de gewenste lasrichting draaien.
- Monteer de juiste **heteluchtgeleider (16)** (zie paragraaf 'Lasrichting').
- Draai de **klenschroef (33)** vast.

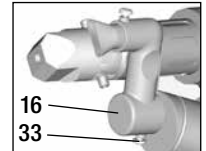

Wisselen van voorverwarmend mondstuk

• Demonteren

- Los bij het **voorverwarmende mondstuk (9)** de **klenschroef (19)** en trek het **voorverwarmende mondstuk (9)** van de **heteluchtgeleider (16)** af.

• Monteren

- Schuif het **voorverwarmende mondstuk (9)** op de **heteluchtgeleider (16)**. Let erop dat heteluchtgeleider en **lasschoen (8)** parallel lopen.
- Draai de **klenschroef (19)** vast.

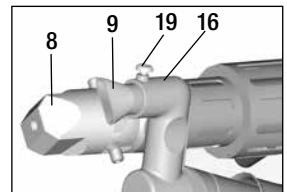

Lasrichting

- Kies de passende heteluchtgeleider bij de geselecteerde lasrichting.

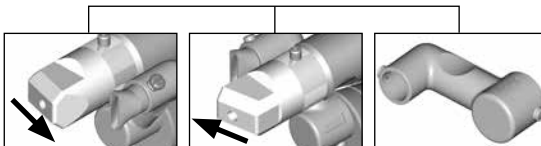

Lasrichting

Heteluchtgeleider



Lasrichting

Heteluchtgeleider

Toebehoren en accessoires

- Gebruik om redenen van techniek en veiligheid uitsluitend toebehoren en/of accessoires van Leister.
- Toebehoren of accessoires vindt u via www.leister.com

Assortiment lasschoenen

- Leister Technologies AG biedt voor alle gangbare lasnaadvormen de bijbehorende lasschoenen in diverse maten aan:

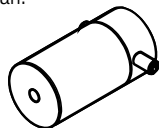

Vormloze naad

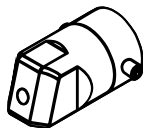

Keelnaad

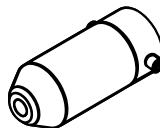

Hoeknaad

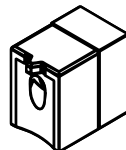







V-naad

Heteluchtgeleider



Voorverwarmend mondstuk

- Leister Technologies AG biedt verscheidene voorverwarmende mondstukken aan om bij het grote assortiment lasschoenen een optimale voorverwarming te verkrijgen

Lasschoen	Breedte van de lasnaad [mm]	Voorverwarmende mondstukken			
		 Breedte 21 mm Lengte 26 mm	 Breedte 21 mm Lengte 42 mm	 ∅ 14 mm Lengte 58 mm afgerond	 ∅ 14 mm Lengte 46 mm
 Keelnaad	5 / 6			• (b)	•
	8 / 10			• (b)	•
	12			• (b)	•
 Hoeknaad				• (b)	•
 V-naad	3 / 4	•	• (a)		
	5 / 6	•	• (a)		
	8 / 10	•	• (a)		

a) DVS-lasschoen analoog WELDPLAST S2-PVC.

b) Afgerond voorverwarmend mondstuk voor het optimaal voorverwarmen van radiale pijplassen.

Onderhoud

- **Netkabel (13)** en stekker op elektrische en mechanische beschadigingen controleren.
- Het **extrudeermondstuk (17)** moet bij elke lasschoenwissel van lasmateriaalresten worden ontdaan.

Service en reparatie

- Reparaties mogen uitsluitend door geautoriseerde **Leister-servicepunten** worden uitgevoerd. Die waarborgen **binnen 24 uur** een vakkundige en betrouwbare **reparatieservice** met originele reserveonderdelen volgens de schakelschema's en reserveonderdeellijsten.
- Verschijnt bij de WELDLAST S1 na het inschakelen van het apparaat de indicatie «Maintenance servicing», dan moet de aandrijfmotor (collector en kooltjes) worden gecontroleerd en indien nodig worden vervangen door een erkend Leister-servicepunt. De indicatie verdwijnt automatisch na 10 seconden of kan direct worden overgeslagen door de **toets (25)**  «Bevestigen» in te drukken.

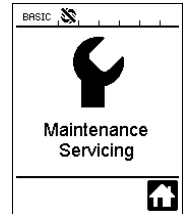

Wettelijke garantie

- Voor dit apparaat gelden de door de directe salespartner/verkoper verleende garantie of de aanspraak op garantie vanaf de datum van aankoop. Bij een garantie of aanspraak op garantie (bewezen door de factuur of leveringsbewijs) de worden productie- of verwerkingfouten hersteld door de salespartner door middel van levering van vervangende onderdelen of reparatie. Verwarmingselementen zijn uitgesloten van de garantie of aanspraak op garantie.
- Verdere garantie of aanspraken op garantie worden in het kader van het dwingende recht uitgesloten.
- Schade als gevolg van normale slijtage, overbelasting of onachtzaam gebruik, is van de garantie uitgesloten.
- Geen garantie of aanspraak op garantie wordt verleend bij apparaten die door de koper zijn omgebouwd of veranderd.



Your authorised Service Centre is:

A large, empty rectangular box with a thin black border, intended for the user to write the name of their authorized service center.

Leister Technologies AG
Galileo-Strasse 10
CH-6056 Kaegiswil/Switzerland
Tel. +41 41 662 74 74
Fax +41 41 662 74 16
www.leister.com
sales@leister.com